



Light for your home
Since 1994



Tadeusz Nowodvorski
Założyciel firmy. Founder of Nowodvorski Lighting

Szanowni Państwo,

Z wielką satysfakcją i radością prezentujemy Państwu najnowszy katalog produktów Nowodvorski Lighting 2019/20. Tegoroczna edycja jest dla nas szczególnie, gdyż podsumowuje 25 lat naszego istnienia. Ostatnie ćwierć wieku było dla nas czasem pełnym wyzwań, stanowiących doskonały impuls do ciągłego rozwoju i budowania silnej pozycji rynkowej. W tym czasie z małej, rodzinnej firmy staliśmy się liderem sektora dekoracyjnych opraw oświetleniowych – zarówno w Polsce, jak i w Europie Środkowo-Wschodniej.

Celom i wartościom, które przyświecały mnie i moim wspólnikom – bratu Wacławowi i bratankowi Bartłomiejowi, w momencie zakładania firmy, jesteśmy wierni również dziś. Oświetlenie to dla nas nie tylko lampa, przedmiot, ale najważniejszy element wystroju wnętrza domowego, budujący jego charakter i klimat. W powstanie każdego z naszych produktów wkładaliśmy i wciąż wkładamy ogrom serca. Świadomość, że oprawy Nowodvorski Lighting trafiają dziś do milionów domów, nie tylko w Polsce, ale też na świecie, napawa nas dumą, a jednocześnie motywuje do dalszego rozwoju. To z myślą o Państwie – naszych klientach, stale śledzimy najnowsze światowe trendy i poszukujemy innowacyjnych rozwiązań, tak, by nasze produkty zachwycały nie tylko wysoką jakością wykonania, ale też nadążały za najnowszymi trendami wnętrzarskimi. Oferujemy nie tylko pojedyncze, modne lampy, ale też podpowiadamy, jak możecie Państwo stworzyć kompleksowe rozwiązania oświetleniowe w swoich domach. Nasz asortyment to nie tylko bogactwo wzorów w różnej stylistyce, od tradycyjnej klasyki po najaktualniejsze trendy współczesnego wzornictwa, ale to także wysoka jakość wywodząca się z centrum Europy.

Jesteśmy niezmiernie dumni z faktu, że w dobie powszechnej optymalizacji wydatków i przenoszenia produkcji do regionów o niższych kosztach produkcyjnych, ale też niższych standardach pracy, my wciąż produkujemy w domu, w Polsce, w centrum Europy. Dodatkowo nasze polskie lampy są obecne na 50 rynkach świata. Idąc pod prąd branży z każdym rokiem inwestujemy w rozwój firmy tu na miejscu, w Częstochowie i Siemianowicach Śląskich – w najnowocześniejszą technologię, automatyzację produkcji, zwiększamy zatrudnienie i moce produkcyjne. Z najwyższą starannością dbamy o relacje z dystrybutorami krajowymi i zagranicznymi, by współpraca z nami była nie tylko korzystna, ale też przyjemna i bez zbędnych formalności.

Zakładając rodzinny biznes 25 lat temu z dużą pokorą i pasją do pracy stawialiśmy nasze pierwsze kroki w branży. Jak się okazało, poprowadziły nas ku świetlanej przyszłości, w której marka Nowodvorski Lighting jest doceniana zarówno przez naszych partnerów handlowych, jak i klientów indywidualnych, z roku na rok umacniając swoją pozycję. Za to zaufanie i sympatię dla naszej marki chcemy Państwu ogromnie podziękować. W imieniu całego zespołu obiecujemy tego zaufania nie zawieść. Kochamy to co robimy, w pełni oddajemy się tej pasji i mamy nadzieję tą dobrą energią dzielić się z Państwem przez kolejne lata, rozświetlając Państwa wnętrza domowe naszymi produktami.

Tadeusz Nowodvorski
Założyciel firmy.

Ladies and Gentlemen,

With great satisfaction and pleasure, we present you the newest product catalogue of Nowodvorski Lighting 2019/20. This year's products collection is special for us, it sums up 25 years of our existence. The last quarter of the century has been a time of challenges for us, a perfect impulse for continuous development and for building a strong market position. During these years, from a small, family-owned company, we have become a leader in the decorative lighting sector - both in Poland and in Central and Eastern Europe.

The goals and values that guided me and my partners - brother Wacław and my nephew Bartłomiej, at the time of starting the company, are also faithful today. Lighting for us is not just a lamp, an object, but the most important element of the home interior design, building its character and atmosphere inside. Creating each of our products, we always put in a lot of heart. Awareness that Nowodvorski Lighting products get to millions of homes today, not only in Poland, but also worldwide, fills us with pride and, at the same time, motivates us to further development. Thinking of our clients and their needs we constantly follow the latest global trends and look for the innovative solutions, in order to our products still delight clients not only with high quality of workmanship, but also keep them updated with the latest interior design trends. We offer not only single, fashionable lamps, but we also advise clients how they can create comprehensive lighting solutions at their homes. Our offer is not only a wealth of designs in a variety of styles, from traditional classic to the latest trends in modern design, but also high quality originating from the centre of Europe.

We are extremely proud of the fact that in the era of widespread expenditure optimization and relocation of production to regions with lower production costs, but also lower labour standards, we still produce at home, in Poland, in the centre of Europe. In addition, our Polish lamps are present in 50 markets worldwide. Every year going against the industry, we invest in the development of the company here, in Częstochowa and Siemianowice Śląskie. We invest in the latest technology, production automation, we increase employment and production capacity. With the utmost attention we take care of relations with country and foreign distributors. We want to keep cooperation not only beneficial for each other's, but also pleasant and without unnecessary formalities.

Establishing a family business 25 years ago, with our humbleness and passion for work, we took our first steps in the lighting sector. As it turned out, they let us to a bright future, in which the Nowodvorski Lighting brand is appreciated by both our trading partners and individual clients, strengthening our position from year to year. For this trust and sympathy for our brand, we would like to thank you very much. On behalf of the entire team, we promise you not to disappoint this trust. We love what we do, we fully devote ourselves to this passion and we hope to share this energy with you over the years, illuminating your home interior with our products.

Tadeusz Nowodvorski
Co-founder of Nowodvorski Lighting



modern



EGG L 9023 WH/G

EGG XL 9026 BL/G

EGG XL 9026 BL/G

EGG XL 9026 BL/G



EGG L 9023 WH/G

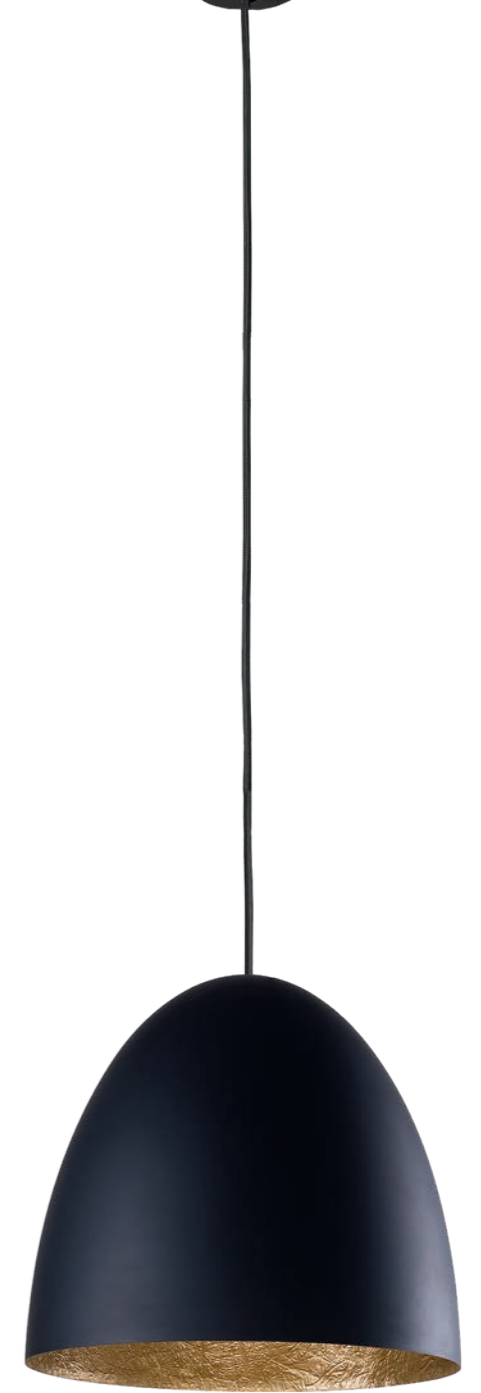

EGG M 9022 BL/G

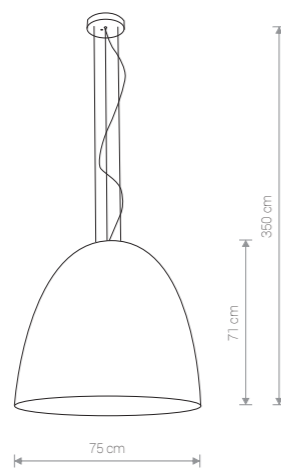

EGG XL

kompozyt / composite / композитный

9026 ● BL/G 9025 ● WH/G

7x E27, max 40W

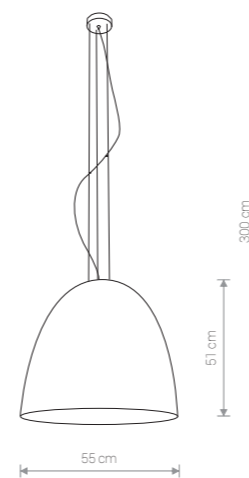

EGG L

kompozyt / composite / композитный

9024 ● BL/G 9023 ● WH/G

5x E27, max 40W

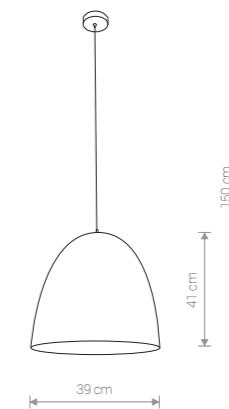

EGG M

kompozyt / composite / композитный

9022 ● BL/G 9021 ● WH/G

1x E27, max 40W



WAVE L 8857 G



WAVE S

stal lakierowana / painted steel /
лакированная сталь

8860 ○ WH 8858 ● BL

Ⓛ 1×E27, max 60W

stal mosiądzowana / electroplated brass /
латунная сталь

8861 ● G

Ⓛ 1×E27, max 60W



WAVE L

stal lakierowana / painted steel /
лакированная сталь

8855 ○ WH 8856 ● BL

Ⓛ 1×E27, max 60W

stal mosiądzowana / electroplated brass /
латунная сталь

8857 ● G

Ⓛ 1×E27, max 60W

WAVE S 8860 WH



WAVE S 8861 G



WAVE L 8856 BL





LUKSOR L 8850 G

LUKSOR S 8853 G

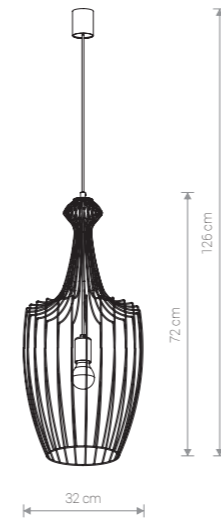

LUKSOR L

stal lakierowana / painted steel /
лакированная сталь

8847 ● BL

Ⓢ 1×E27, max 60W

stal mosiądzowana / electroplated brass /
латунная сталь

8850 ● G

Ⓢ 1×E27, max 60W

LUKSOR L 8847 BL

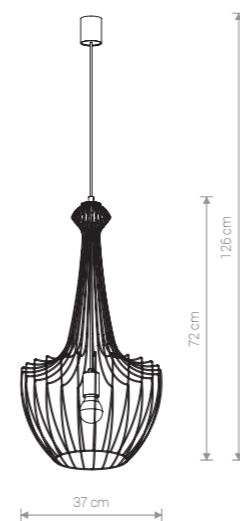

LUKSOR S

stal lakierowana / painted steel /
лакированная сталь

8851 ● BL

Ⓢ 1×E27, max 60W

stal mosiądzowana / electroplated brass /
латунная сталь

8853 ● G

Ⓢ 1×E27, max 60W

LUKSOR S 8851 BL





LUKSOR PLUS S 8852 WH

LUKSOR PLUS L 8848 WH

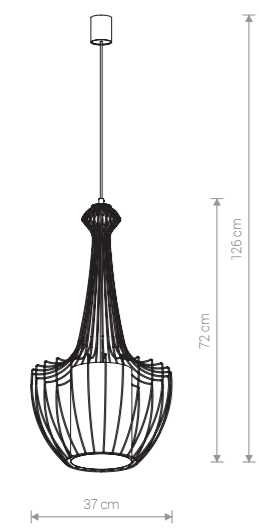

LUKSOR PLUS S

stal lakierowana, abażur / painted steel, shade /
лакированная сталь, абажур

8852 ○ WH

1×E27, max 40W



LUKSOR PLUS L

stal lakierowana, abażur / painted steel, shade /
лакированная сталь, абажур

8848 ○ WH

1×E27, max 40W

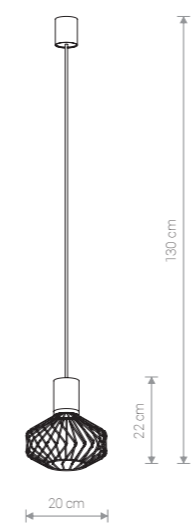

PICO

stal lakierowana, stal mosiądzowana /
painted steel, electroplated brass /
лакированная сталь, латунная сталь

8862 ● BL/G

1×GU10, max 35W

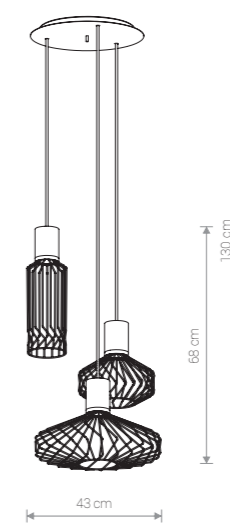

PICO

stal lakierowana, stal mosiądzowana /
painted steel, electroplated brass /
лакированная сталь, латунная сталь

8863 ● BL/G

3×GU10, max 35W

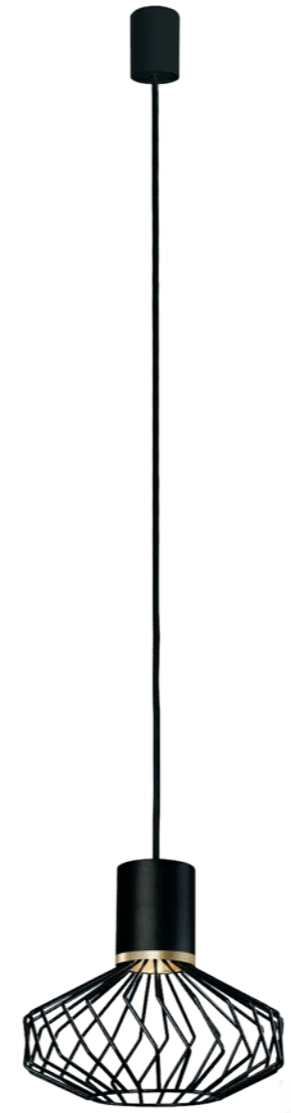

PICO 8862 BL/G



PICO 8863 BL/G



ABI L 8865 WH



ABI M 8866 BL



ABI S 8870 BL



ABI L 8864 BL



ABI M

stal lakierowana, abażur / painted steel, shade /
лакированная сталь, абажур

8867 ○ WH 8866 ● BL

Ⓧ 1×E27, max 40W



ABI S

stal lakierowana, abażur / painted steel, shade /
лакированная сталь, абажур

8868 ○ WH 8870 ● BL

Ⓧ 1×E27, max 40W

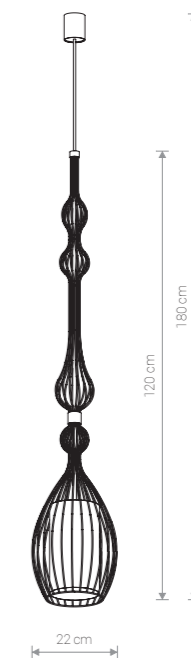

ABI L

stal lakierowana, abażur / painted steel, shade /
лакированная сталь, абажур

8865 ○ WH 8864 ● BL

Ⓧ 1×E27, max 40W



GSTAR 8854 G/BL



UMBRELLA 8874 G/BL



GSTAR

stal mosiądzowana, stal lakierowana /
electroplated brass, painted steel /
латунная сталь, лакированная сталь

8854 G/BL

1×GU10, max 35W

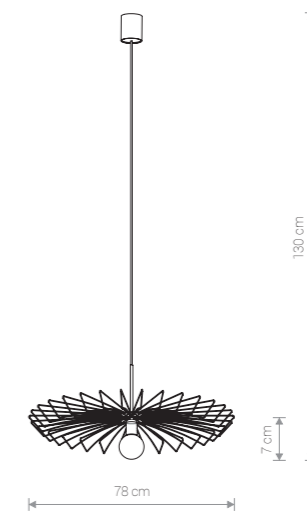

UMBRELLA

stal mosiądzowana, stal lakierowana /
electroplated brass, painted steel /
латунная сталь, лакированная сталь

8874 G/BL

1×E27, max 60W

stal lakierowana / painted steel /
лакированная сталь

8873 BL

1×E27, max 60W

KAREN 4608 WH



KAREN

stal lakierowana, abażur / painted steel, shade /
лакированная сталь, абажур

4608 ○ WH 4607 ● BL

1×E27, max 40W

AIDA 4614 BL



AIDA

stal lakierowana, abażur / painted steel, shade /
лакированная сталь, абажур

4614 ● BL 4615 ○ WH

1×E27, max 40W

CAMILLA 4610 BL



CAMILLA

stal lakierowana, abażur / painted steel, shade /
лакированная сталь, абажур

4610 ● BL 4611 ○ WH

1×E27, max 40W

AVEIRO 5126 BL



AVEIRO 5410 WH



AVEIRO

stal lakierowana, abażur / painted steel, shade /
лакированная сталь, абажур

5410 ○ WH 5411 ● BL

1×E27, max 40W



AVEIRO

stal lakierowana, abażur / painted steel, shade /
лакированная сталь, абажур

5125 ○ WH 5126 ● BL

1×E27, max 40W



NESS 6767 WH

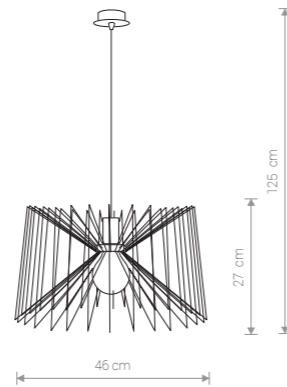

NESS

stal lakierowana / painted steel / лакированная сталь

6767 ○ WH 6768 ● BL

1×E27, max 60W



CAGE 6844 BL

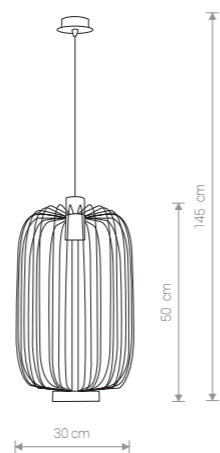

CAGE

stal lakierowana / painted steel / лакированная сталь

6844 ● BL

1×GU10, max 35W



ALLAN 6940 WH



ALLAN

stal lakierowana / painted steel / лакированная сталь

6940 ○ WH 6941 ● BL

1×GU10, max 35W



AGADIR 5300 WH

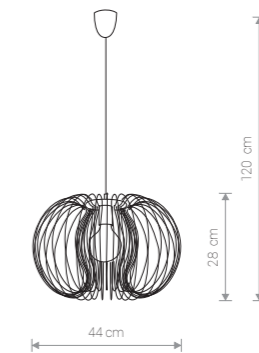

AGADIR

stal lakierowana / painted steel / лакированная сталь

5300 ○ WH 5301 ● BL

1×E27, max 60W



MERSEY 5296 BL

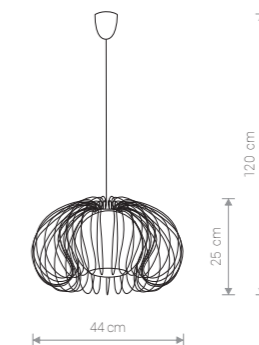

MERSEY

stal lakierowana, szkło / painted steel, glass / лакированная сталь, стекло

5295 ○ WH 5296 ● BL

1×E27, max 60W



MEKNES 5297 WH



MEKNES

stal lakierowana / painted steel / лакированная сталь

5297 ○ WH 5298 ● BL

1×E27, max 60W



PERTH 5492 BL

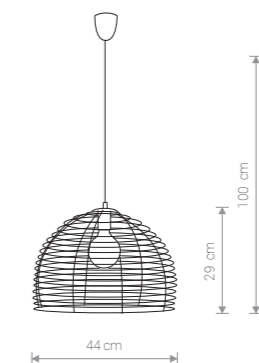

PERTH

stal lakierowana / painted steel / лакированная сталь

5491 ○ WH 5492 ● BL

1×E27, max 60W



STICKS 9076 G

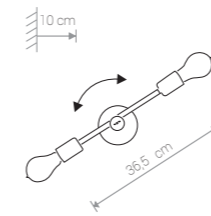

STICKS

stal lakierowana / painted steel /
лакированная сталь

9077 ● G

2×E27, max 60W

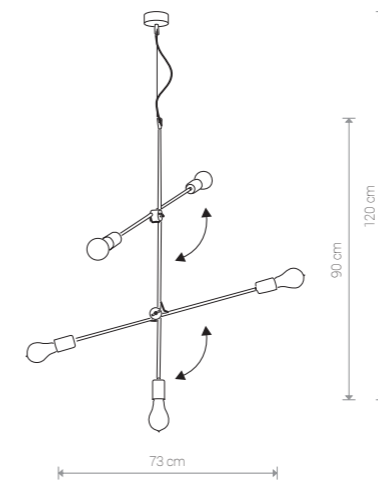

STICKS

stal lakierowana / painted steel /
лакированная сталь

9076 ● G

5×E27, max 60W



STICKS 9077 G



STICKS 9735 BL/CO

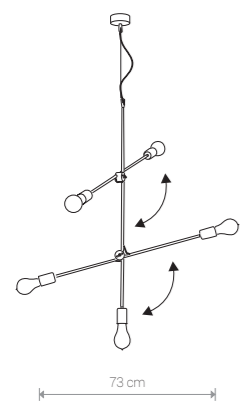

STICKS

stal lakierowana / painted steel / лакированная сталь

6270 ● BL/CO

Ⓢ 5×E27, max 60W

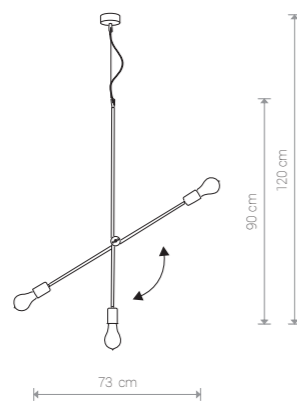

STICKS

stal lakierowana / painted steel / лакированная сталь

6268 ● BL/CO

Ⓢ 3×E27, max 60W

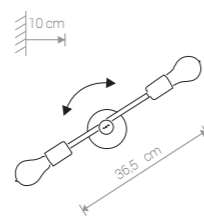

STICKS

stal lakierowana / painted steel / лакированная сталь

6267 ● BL/CO

Ⓢ 2×E27, max 60W

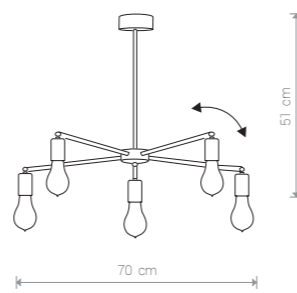

STICKS

stal lakierowana / painted steel / лакированная сталь

9735 ● BL/CO

Ⓢ 5×E27, max 60W



STICKS 6268 BL/CO



AXIS 9294 BL/G

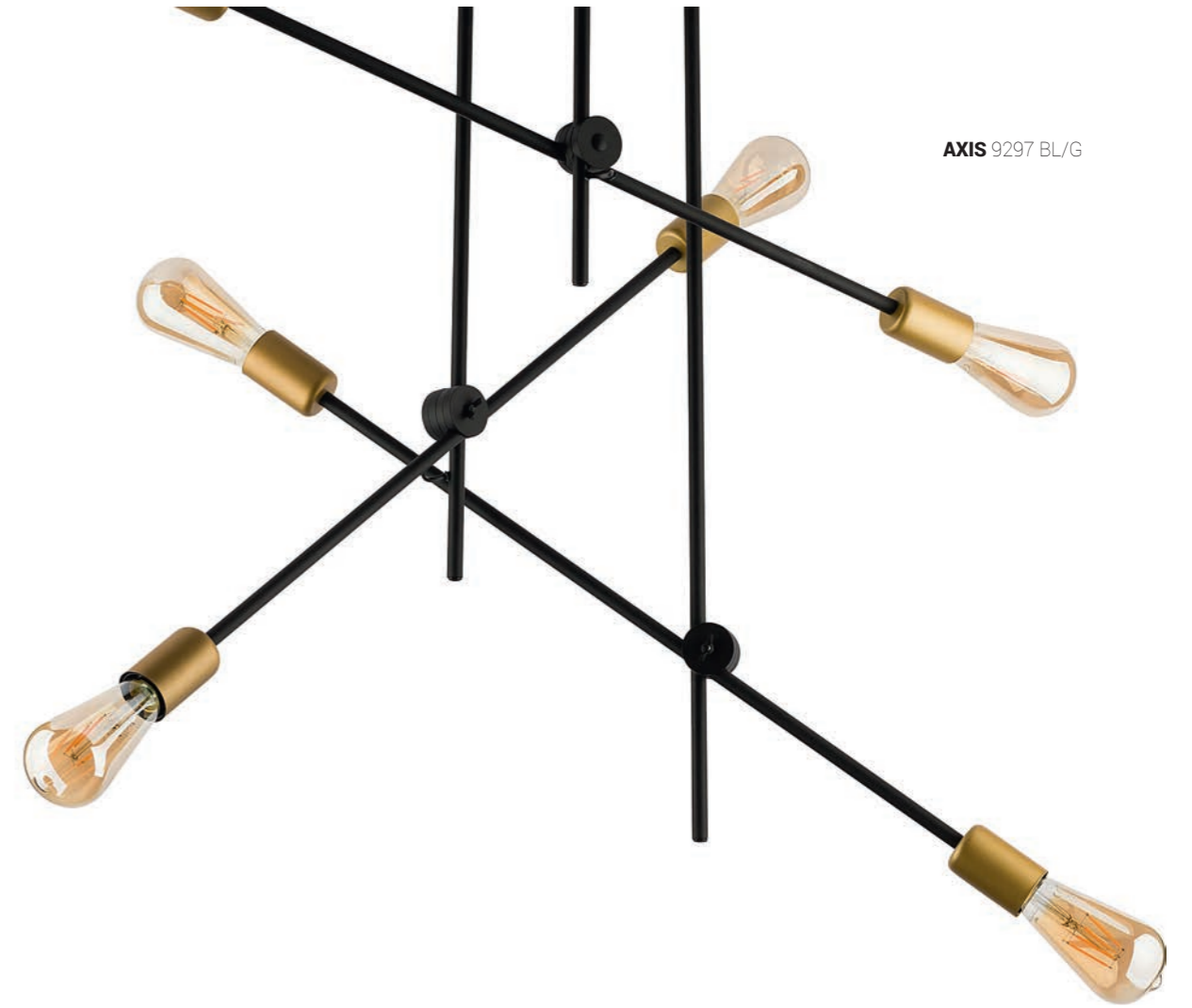

AXIS 9297 BL/G

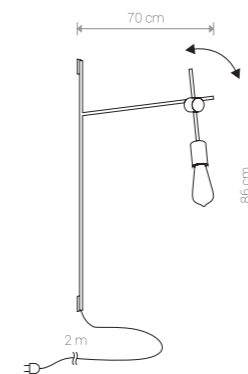

AXIS

stal lakierowana / painted steel / лакированная сталь

9294 ● BL/G

Ⓛ 1×E27, max 60W

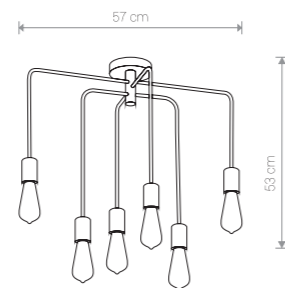

AXIS

stal lakierowana / painted steel / лакированная сталь

9296 ● BL/G

Ⓛ 6×E27, max 60W

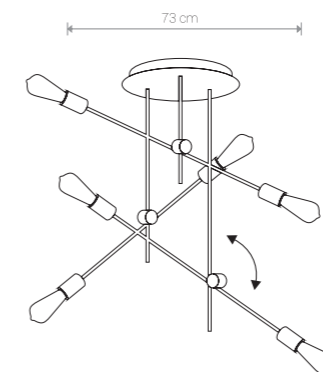

AXIS

stal lakierowana / painted steel / лакированная сталь

9297 ● BL/G

Ⓛ 6×E27, max 60W



ROD 9733 BL

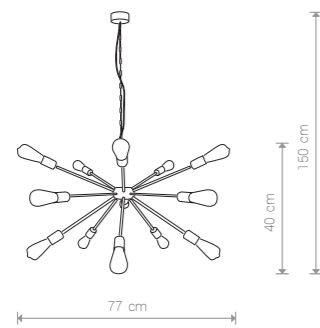

ROD

stal lakierowana / painted steel / лакированная сталь

9733 ● BL 9027 ● G

Ⓛ 15×E27, max 60W

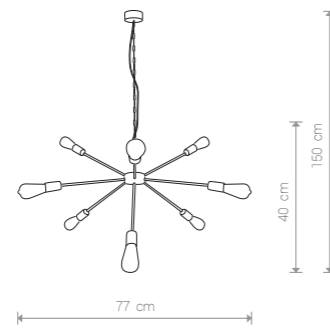

ROD

stal lakierowana / painted steel / лакированная сталь

9734 ● BL 9130 ● G

Ⓛ 9×E27, max 60W



ROD 9130 G

CRATE 9045 BL



CRATE 9046 BL



CRATE 9047 BL

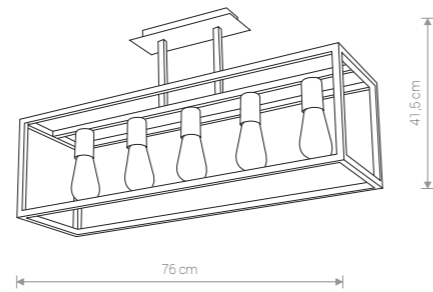
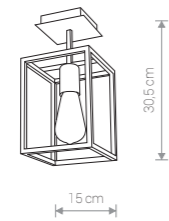
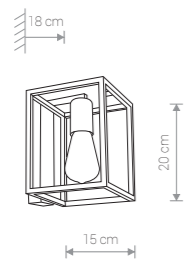

CRATE

stal lakierowana / painted steel /
лакированная сталь

9046 ● BL

1×E27, max 60W

CRATE

stal lakierowana / painted steel /
лакированная сталь

9045 ● BL

1×E27, max 60W

CRATE

stal lakierowana / painted steel /
лакированная сталь

9047 ● BL

5×E27, max 60W



CRATE 9047 BL



PILE 9127 BL

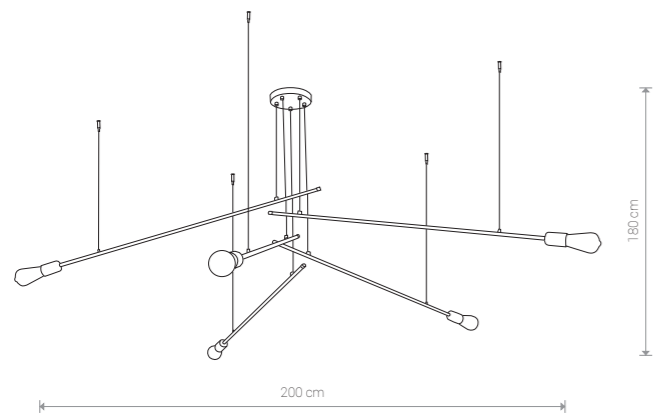

PILE

stal lakierowana / painted steel / лакированная сталь

9127 ● BL

5×E27, max 60W

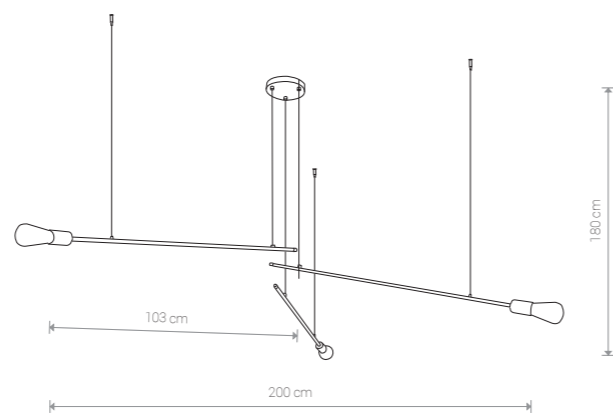

PILE

stal lakierowana / painted steel / лакированная сталь

9128 ● BL

3×E27, max 60W



MILL 9135 BL/G



MILL 9136 BL/G

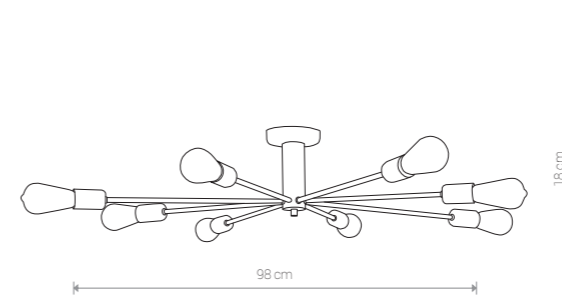

MILL

stal lakierowana / painted steel / лакированная сталь

9135 ● BL/G

8×E27, max 60W

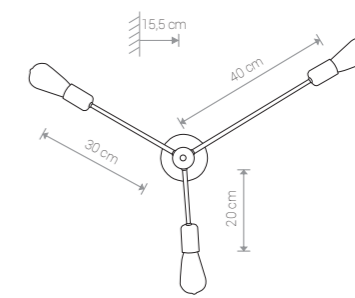

MILL

stal lakierowana / painted steel / лакированная сталь

9136 ● BL/G

3×E27, max 60W



TWIG 9138 BL

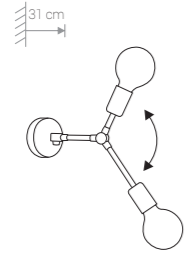

TWIG

stal lakierowana / painted steel /
лакированная сталь

9141 ● BL

Ⓢ 2×E27, 60W

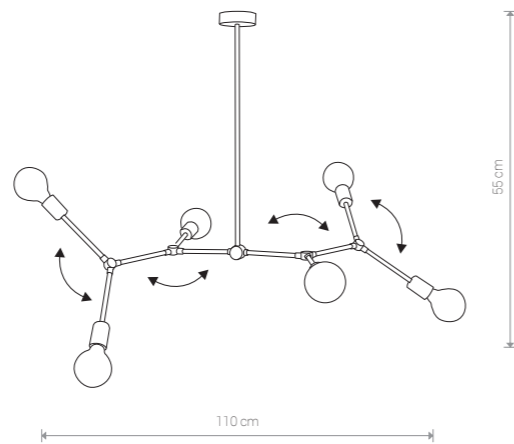

TWIG

stal lakierowana / painted steel /
лакированная сталь

9138 ● BL

Ⓢ 6×E27, 60W



TWIG 9140 BL

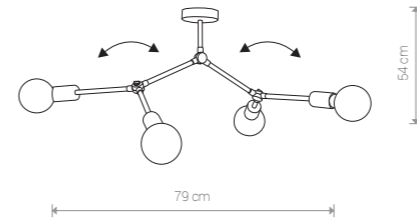

TWIG

stal lakierowana / painted steel /
лакированная сталь

9140 ● BL

Ⓢ 4×E27, 60W



TWIG 9137 BL

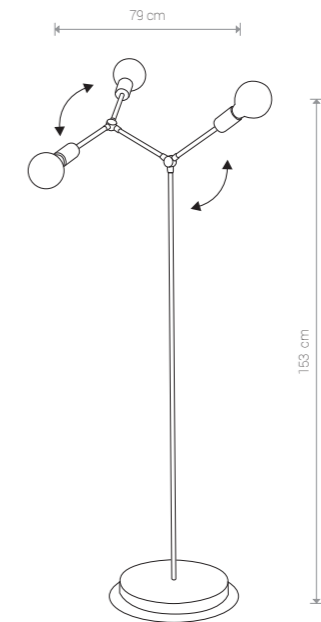

TWIG

stal lakierowana / painted steel /
лакированная сталь

9137 ● BL

Ⓢ 3×E27, 60W



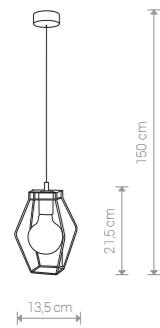

FIORD

stal lakierowana / painted steel /
лакированная сталь

9670 ● BL

1×E27, max 60W

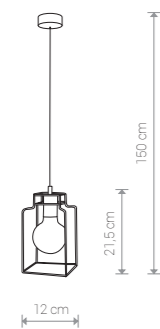

FIORD

stal lakierowana / painted steel /
лакированная сталь

9668 ● BL

1×E27, max 60W

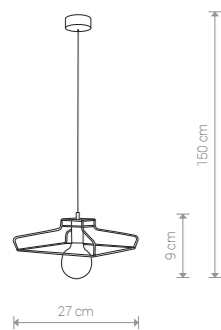

FIORD

stal lakierowana / painted steel /
лакированная сталь

9667 ● BL

1×E27, max 60W

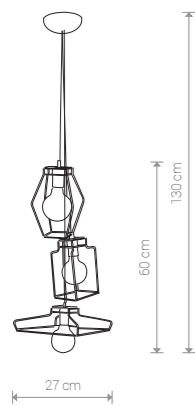

FIORD

stal lakierowana / painted steel /
лакированная сталь

9666 ● BL

3×E27, max 60W

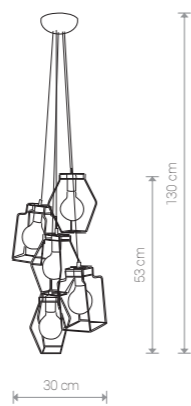

FIORD

stal lakierowana / painted steel /
лакированная сталь

9665 ● BL

5×E27, max 60W





WORKSHOP 6337 BL/CO

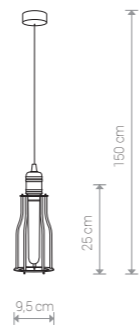

WORKSHOP

stal lakierowana / painted steel /
лакированная сталь

6337 ● BL/CO

1×E27, max 60W

WORKSHOP 6336 BL/CO



WORKSHOP 6335 BL/CO

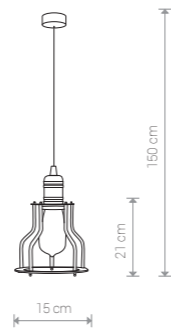

WORKSHOP

stal lakierowana / painted steel /
лакированная сталь

6336 ● BL/CO

1×E27, max 60W

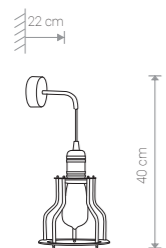

WORKSHOP

stal lakierowana / painted steel /
лакированная сталь

6606 ● BL/CO

1×E27, max 60W

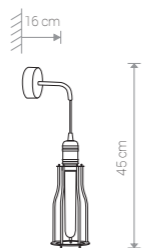

WORKSHOP

stal lakierowana / painted steel /
лакированная сталь

6605 ● BL/CO

1×E27, max 60W

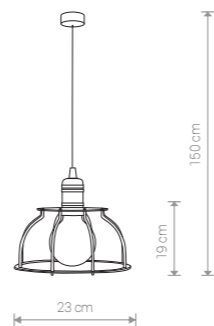

WORKSHOP

stal lakierowana / painted steel /
лакированная сталь

6335 ● BL/CO

1×E27, max 60W



WORKSHOP 9631 BL/CO

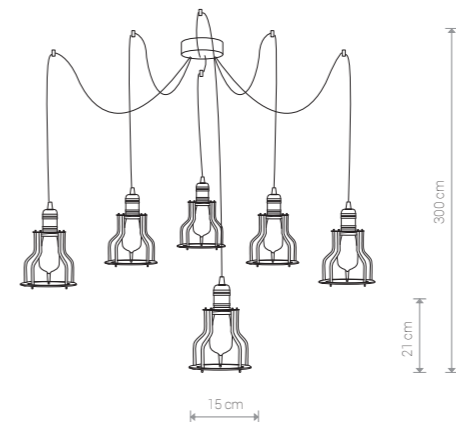

WORKSHOP

stal lakierowana / painted steel /
лакированная сталь

9631 ● BL/CO

6×E27, max 60W

MANUFACTURE 9740 BL/CO

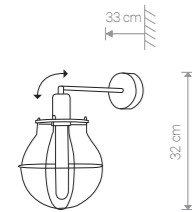

MANUFACTURE

stal lakierowana / painted steel /
лакированная сталь

9742 ● BL/CO

Ⓛ 1×E27, max 60W



MANUFACTURE

stal lakierowana / painted steel /
лакированная сталь

9741 ● BL/CO

Ⓛ 1×E27, max 60W

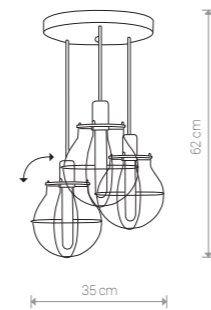

MANUFACTURE

stal lakierowana / painted steel /
лакированная сталь

9740 ● BL/CO

Ⓛ 3×E27, max 60W

MANUFACTURE 9738 BL/CO

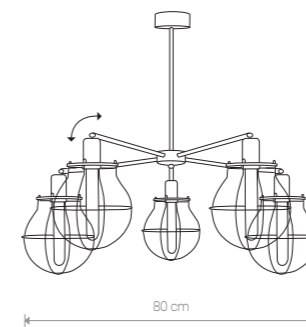

MANUFACTURE

stal lakierowana / painted steel /
лакированная сталь

9738 ● BL/CO

Ⓛ 5×E27, max 60W

BULLET 9061 G



BULLET

stal lakierowana / painted steel /
лакированная сталь

9061 ● G

Ⓢ 3×E27, max 60W



STALACTITE 9054 BL/BS

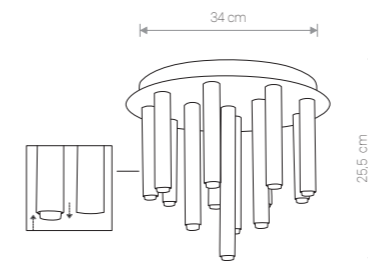

STALACTITE

mosiądz, stal lakierowana / brass, painted steel /
латунь, лакированная сталь

9054 ● BL/BS

Ⓢ 13×G9, max 10W, only LED



STALACTITE 9055 BL/BS

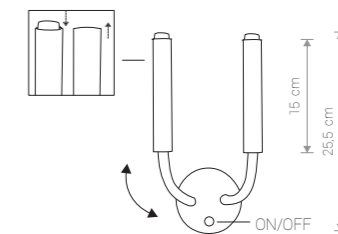

STALACTITE

mosiądz, stal lakierowana, peszel /
brass, painted steel, protective pipe /
латунь, лакированная сталь, кабель-канал

9055 ● BL/BS

Ⓢ 2×G9, max 10W, only LED

LASER 8920 BL

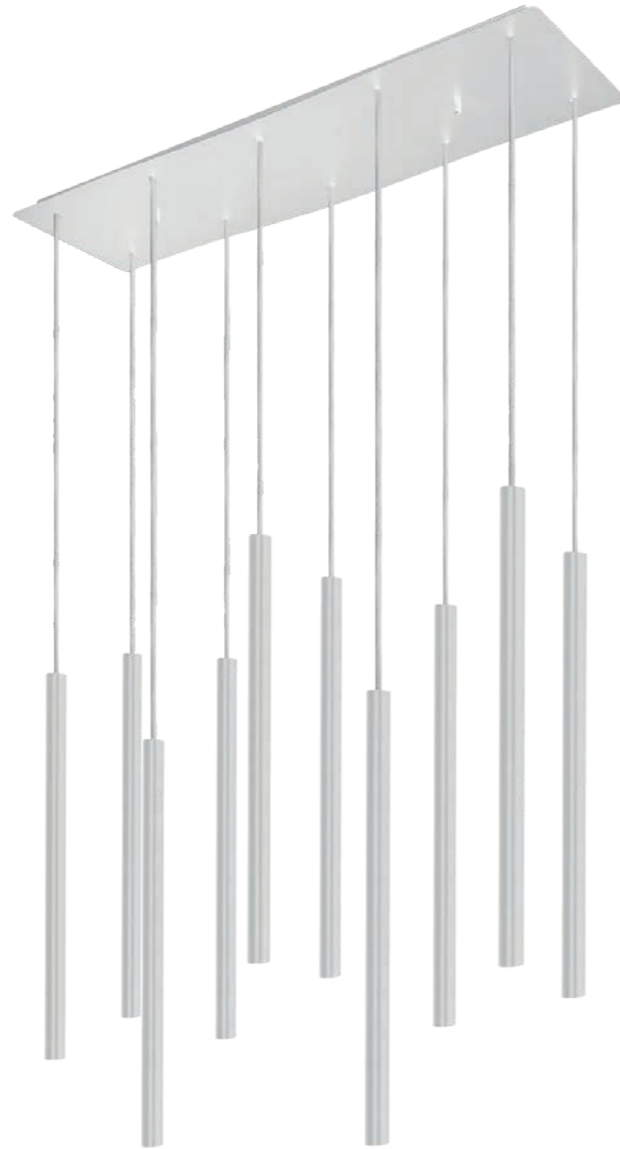
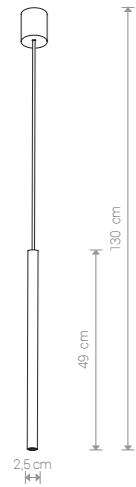

LASER 8922 WH

LASER

stal lakierowana / painted steel /
лакированная сталь

8796 ○ WH 8797 ● BL

Ⓢ 1xG9, max 10W, only LED

mosiądz, stal lakierowana /
brass, painted steel /
латунь, лакированная сталь

8798 ● BS/BL

Ⓢ 1xG9, max 10W, only LED

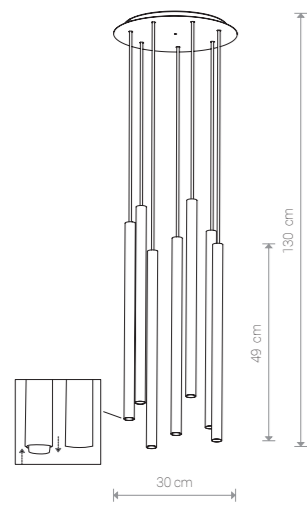

LASER

stal lakierowana / painted steel /
лакированная сталь

8918 ○ WH 8920 ● BL

Ⓢ 7xG9, max 10W, only LED

mosiądz, stal lakierowana /
brass, painted steel /
латунь, лакированная сталь

8921 ● BS/BL

Ⓢ 7xG9, max 10W, only LED

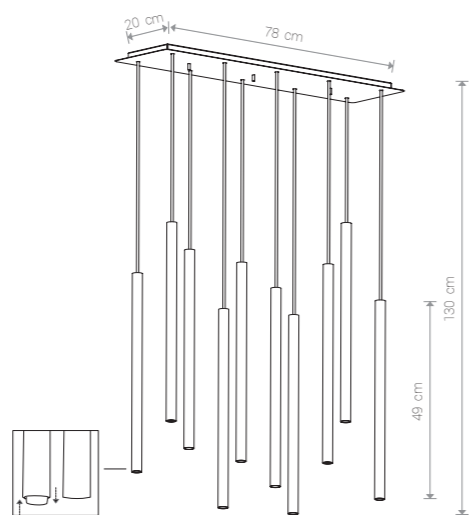

LASER

stal lakierowana / painted steel /
лакированная сталь

8922 ○ WH 8923 ● BL

Ⓢ 10xG9, max 10W, only LED

mosiądz, stal lakierowana /
brass, painted steel /
латунь, лакированная сталь

8924 ● BS/BL

Ⓢ 10xG9, max 10W, only LED



LASER 8924 BS/BL



EYE M 8914 BS/BL

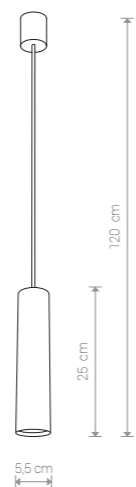

EYE M

mosiądz, stal lakierowana / brass, painted steel /
латунь, лакированная сталь

8914 ● BS/BL

Ⓛ 1xGU10, max 10W, only LED

EYE L 8800 BS/BL

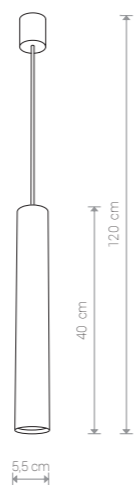

EYE L

mosiądz, stal lakierowana / brass, painted steel /
латунь, лакированная сталь

8800 ● BS/BL

Ⓛ 1xGU10, max 10W, only LED



EYE S

mosiądz / brass / латунь

8911 ● BS

Ⓛ 1xGU10, max 35W

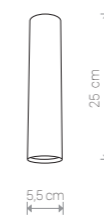

EYE M

mosiądz / brass / латунь

8912 ● BS

Ⓛ 1xGU10, max 35W



EYE L

mosiądz / brass / латунь

8913 ● BS

Ⓛ 1xGU10, max 35W

EYEL 8915 BS/BL



EYEL 8916 WH



EYEL 8917 BL

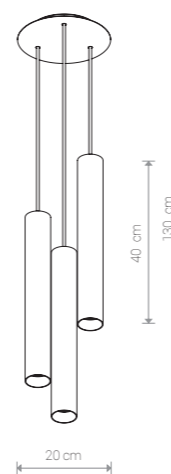

EYEL

stal lakierowana / painted steel /
лакированная сталь

8916 ○ WH 8917 ● BL

3×GU10, max 10W, only LED

mosiądz, stal lakierowana / brass, painted steel /
латунь, лакированная сталь

8915 ● BS/BL

3×GU10, max 10W, only LED



EYEL 5473 SI



EYEM 5464 GR



EYES 6836 BL

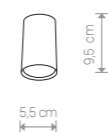

EYES

stal lakierowana / painted steel / лакирована сталь

5255 ○ WH 5257 ○ SI

5256 ● GR 6836 ● BL

1×GU10, max 35W

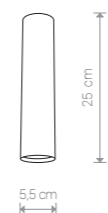

EYEM

stal lakierowana / painted steel / лакирована сталь

5463 ○ WH 5465 ○ SI

5464 ● GR 6837 ● BL

1×GU10, max 35W



EYEL

stal lakierowana / painted steel / лакирована сталь

5471 ○ WH 5473 ○ SI

5472 ● GR 6838 ● BL

1×GU10, max 35W

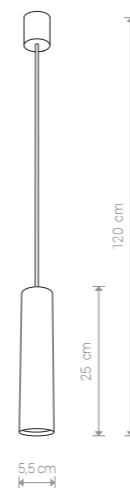

EYEM

stal lakierowana / painted steel / лакирована сталь

5397 ○ WH 5400 ○ SI

5398 ● GR 6840 ● BL

1×GU10, max 10W, only LED

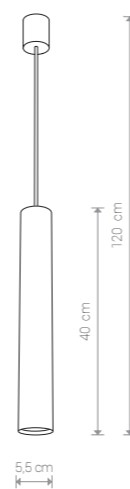

EYEL

stal lakierowana / painted steel / лакирована сталь

5455 ○ WH 5457 ○ SI

5456 ● GR 6841 ● BL

1×GU10, max 10W, only LED



EYEM 5400 SI



EYEL 5456 GR



EYEL 5455 WH



EYE FLEX S 9070 WH



EYE FLEX S 9068 BL



EYE FLEX S 9067 BS/BL

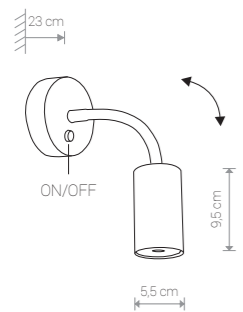

EYE FLEX S

stal lakierowana, peszel / painted steel, protective pipe /
лакированная сталь, кабель-канал

9070 ○ WH 9068 ● BL

Ⓛ 1×GU10, max 10W, only LED

mosiądz, peszel /brass, protective pipe /
латунь, кабель-канал

9067 ● BS/BL

Ⓛ 1×GU10, max 10W, only LED

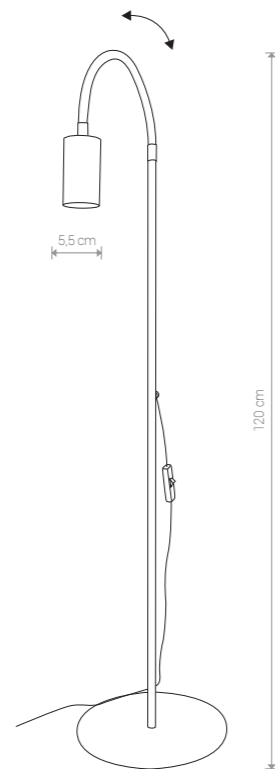

EYE FLEX S

stal lakierowana, peszel / painted steel, protective pipe /
лакированная сталь, кабель-канал

8934 ○ WH 8935 ● BL

Ⓛ 1×GU10, max 10W, only LED



EYE FLEX S 8935 BL

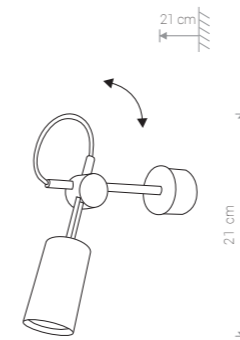

EYE S

stal lakierowana / painted steel / лакирована сталь

5654 ○ WH 5656 ○ SI

5655 ● GR 6842 ● BL

Ⓛ 1×GU10, max 35W

EYE S 5654 WH



EYE S 5656 SI



EYE S 5655 GR



EYE S 6842 BL





EYE SUPER B 6503 BL

EYE SUPER A 6495 GR



EYE SUPER B 6490 WH

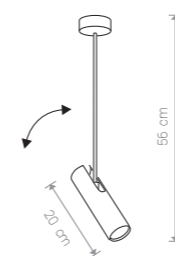

EYE SUPER A

stal lakierowana / painted steel / лакирована сталь

6488 ○ WH 6495 ● GR 6502 ● BL

1×GU10, max 35W

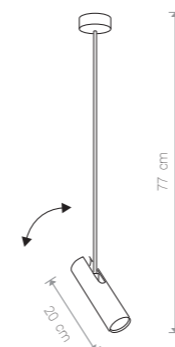

EYE SUPER B

stal lakierowana / painted steel / лакирована сталь

6490 ○ WH 6496 ● GR 6503 ● BL

1×GU10, max 35W

EYE SUPER 6494 GR

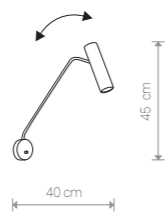

EYE SUPER

stal lakierowana / painted steel / лакирована сталь

6487 ○ WH 6494 ● GR 6501 ● BL

1×GU10, max 35W

EYE SUPER 6497 GR

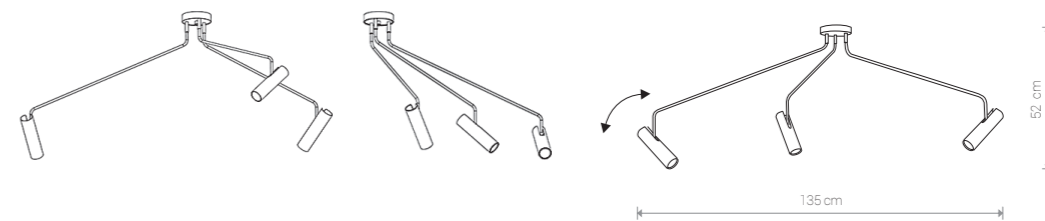
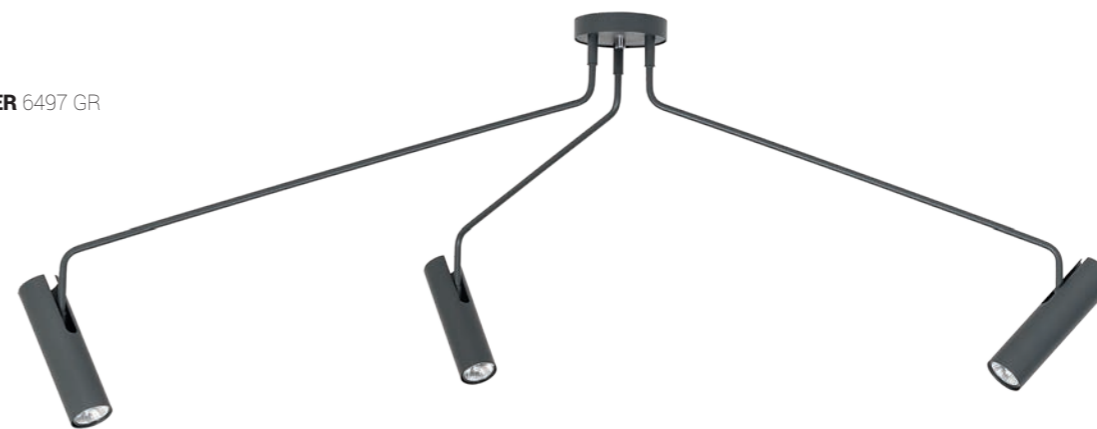

EYE SUPER

stal lakierowana / painted steel / лакирована сталь

6491 ○ WH 6497 ● GR 6504 ● BL

3×GU10, max 35W

EYE SUPER C 6630 WH

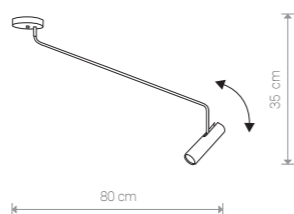

EYE SUPER C

stal lakierowana / painted steel / лакирована сталь

6630 ○ WH 6631 ● GR 6632 ● BL

1×GU10, max 35W

EYE SUPER 6505 BL

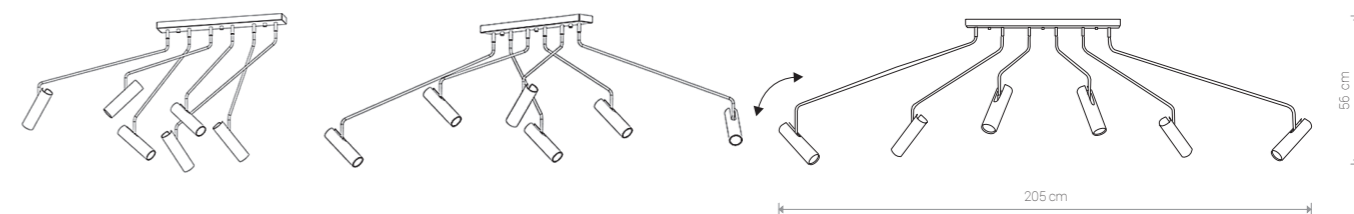

EYE SUPER

stal lakierowana / painted steel / лакирована сталь

6492 ○ WH 6498 ● GR 6505 ● BL

6×GU10, max 35W

EYE SUPER 6506 BL

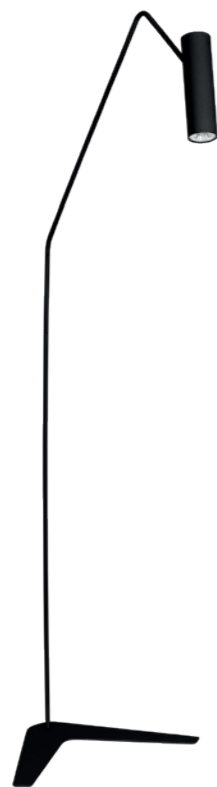

EYE SUPER

stal lakierowana / painted steel / лакирована сталь

6493 ○ WH 6500 ● GR 6506 ● BL

1×GU10, max 35W

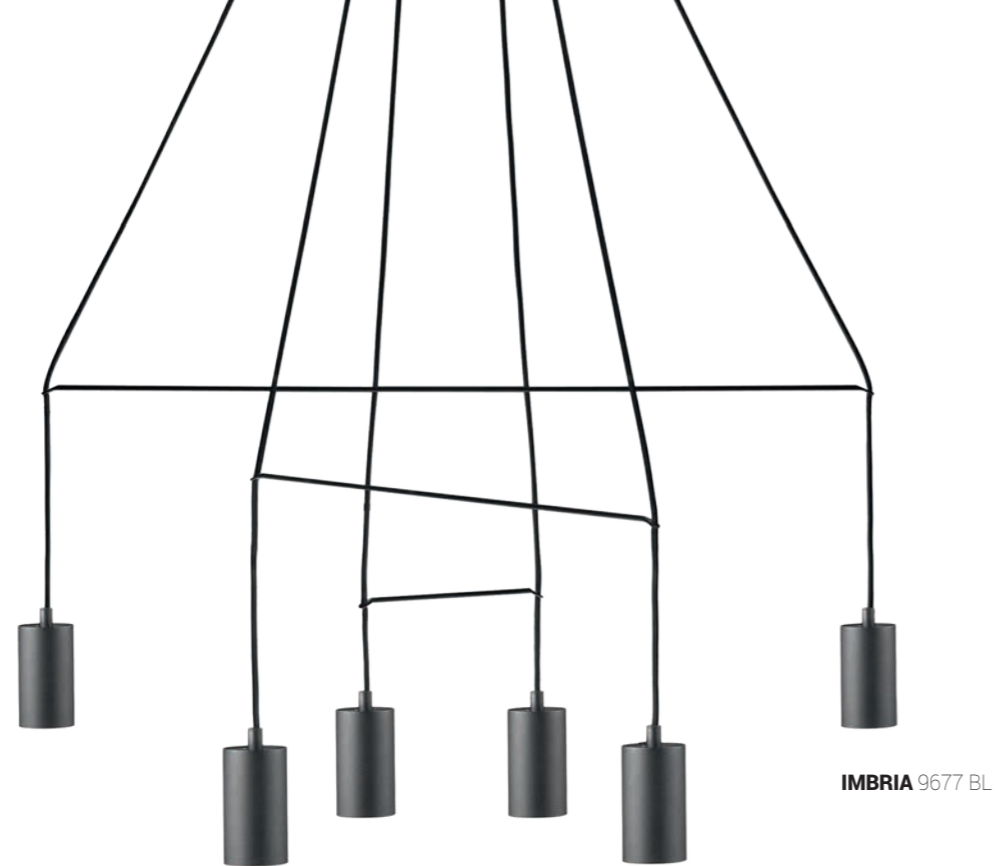

IMBRIA 9677 BL

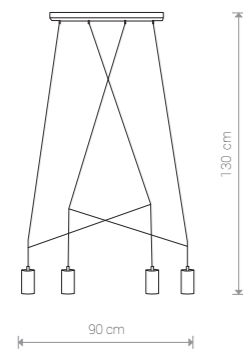

IMBRIA

stal lakierowana, kabel w oplocie / painted steel, braided cable /
лакирована сталь, кабель в оплетке

9191 ○ WH 9192 ● BL

Ⓢ 4×GU10, max 35W

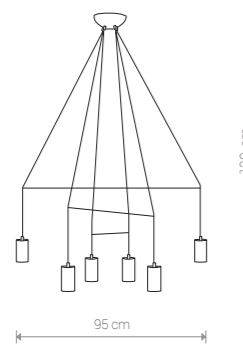

IMBRIA

stal lakierowana, kabel w oplocie / painted steel, braided cable /
лакирована сталь, кабель в оплетке

9676 ○ WH 9677 ● BL

Ⓢ 6×GU10, max 35W

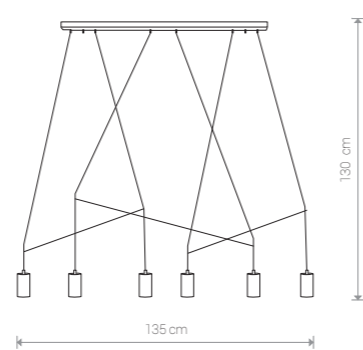

IMBRIA

stal lakierowana, kabel w oplocie / painted steel, braided cable /
лакирована сталь, кабель в оплетке

9674 ○ WH 9675 ● BL

Ⓢ 6×GU10, max 35W

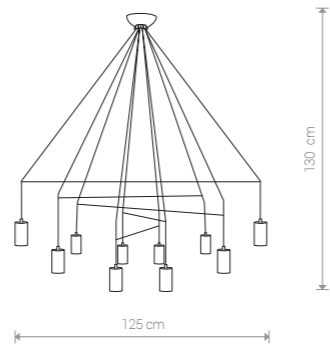

IMBRIA

stal lakierowana, kabel w oplocie / painted steel, braided cable /
лакирована сталь, кабель в оплетке

9678 ○ WH 9680 ● BL

Ⓢ 10×GU10, max 35W



IMBRIA 9674 WH



QUEBECK 5405 BL

QUEBECK 5404 WH



QUEBECK 5405 BL

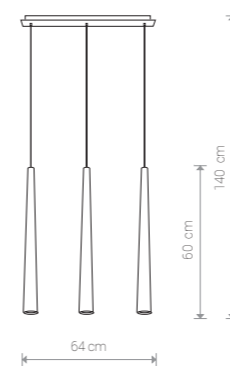

QUEBECK

stal lakierowana / painted steel / лакированная сталь

5404 ○ WH 5406 ● BL

Ⓛ 3×GU10, max 35W

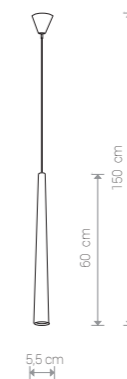

QUEBECK

stal lakierowana / painted steel / лакированная сталь

5403 ○ WH 5405 ● BL

Ⓛ 1×GU10, max 35W



POLY M 8878 BL



POLY M 8877 WH



POLY S 8876 BL



POLY S 8875 WH



POLY S

aluminium lakierowane / painted aluminum / лакированный алюминий

8875 ○ WH 8876 ● BL

1×GU10, max 35W

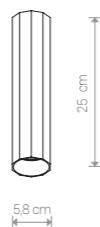

POLY M

aluminium lakierowane / painted aluminum / лакированный алюминий

8877 ○ WH 8878 ● BL

1×GU10, max 35W

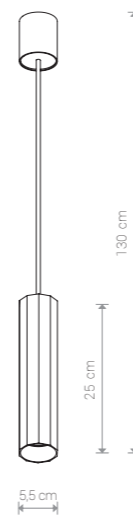

POLY M

aluminium lakierowane / painted aluminum / лакированный алюминий

8880 ○ WH 8881 ● BL

1×GU10, 10W only LED

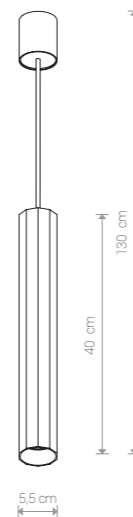

POLY L

aluminium lakierowane / painted aluminum / лакированный алюминий

8882 ○ WH 8883 ● BL

1×GU10, 10W only LED

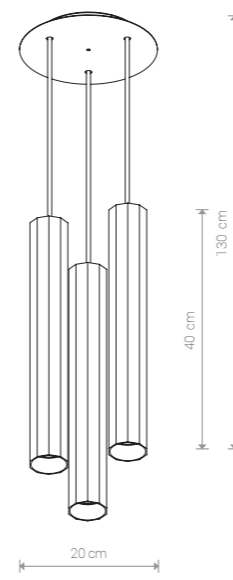

POLY

aluminium lakierowane / painted aluminum / лакированный алюминий

8884 ○ WH 8885 ● BL

3×GU10, 10W only LED



POLY M 8881 BL



POLY L 8882 WH



POLY 8885 BL

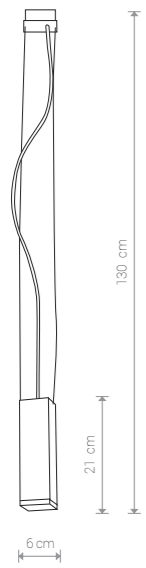

BRYCE S

aluminium, szkło / aluminium, glass / алюминий, стекло

5673 ○ WH 5680 ● CN 5676 ● GR

1×GU10, max 35W

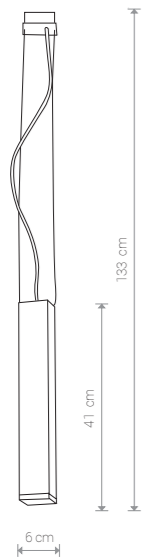

BRYCE M

aluminium, szkło / aluminium, glass / алюминий, стекло

5674 ○ WH 5681 ● CN 5677 ● GR

1×GU10, max 35W

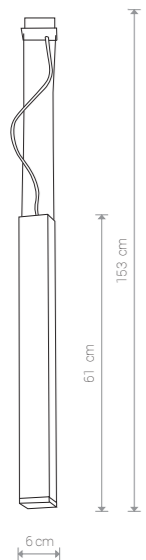

BRYCE L

aluminium, szkło / aluminium, glass / алюминий, стекло

5675 ○ WH 5682 ● CN 5678 ● GR

1×GU10, max 35W

BRYCE 5675 WH



BRYCE 5677 GR

BRYCE 5680 CN

BRYCE S 5718 CN



BRYCE M 5710 GR



BRYCE L 5707 WH

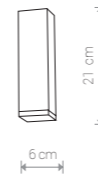

BRYCE S

aluminium, szkło / aluminium, glass / алюминий, стекло

5705 ○ WH 5718 ● CN 5708 ● GR

1×GU10, max 35W



BRYCE M

aluminium, szkło / aluminium, glass / алюминий, стекло

5706 ○ WH 5720 ● CN 5710 ● GR

1×GU10, max 35W



BRYCE L

aluminium, szkło / aluminium, glass / алюминий, стекло

5707 ○ WH 5721 ● CN 5711 ● GR

1×GU10, max 35W



PERM 9147 BL/G

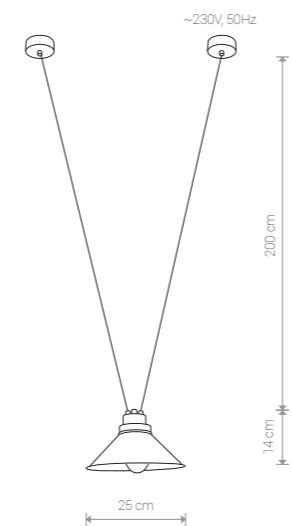

PERM

stal lakierowana / painted steel / лакированная сталь

9148 ● BL/G

1×E27, max 60W

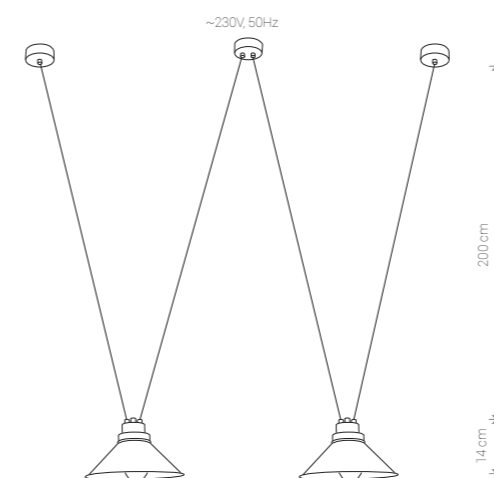

PERM

stal lakierowana / painted steel / лакированная сталь

9147 ● BL/G

2×E27, max 60W

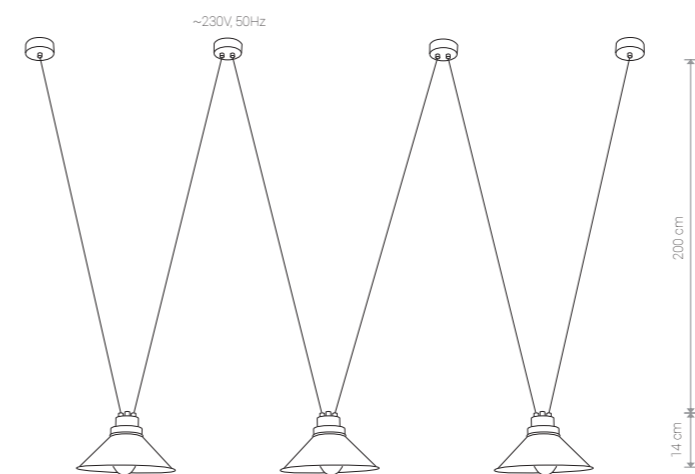

PERM

stal lakierowana / painted steel / лакированная сталь

9146 ● BL/G

3×E27, max 60W

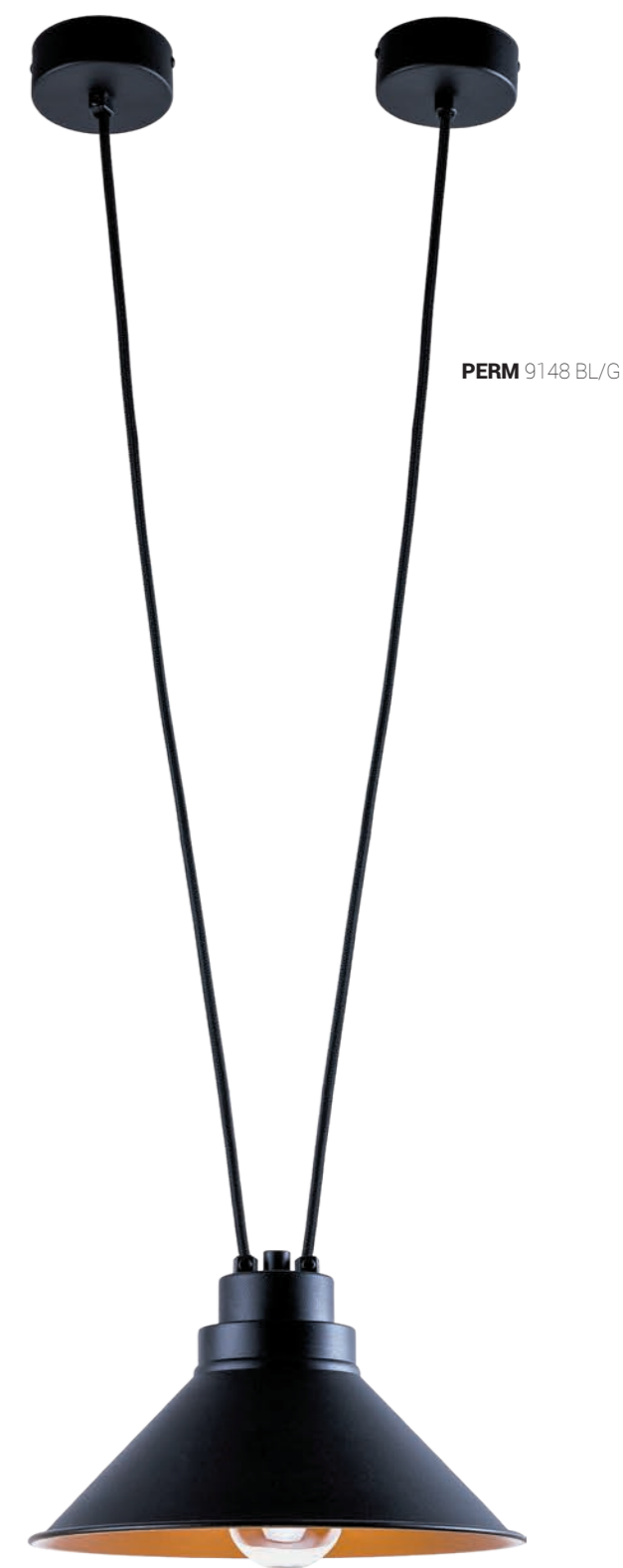

PERM 9148 BL/G



TECHNO 9145 BL/WH

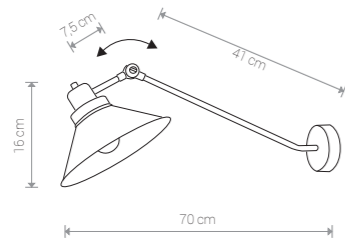

TECHNO

stal lakierowana / painted steel /
лакированная сталь

9145 ● BL/WH

Ⓢ 1×E27, max 60W



TECHNO 9144 BL/WH

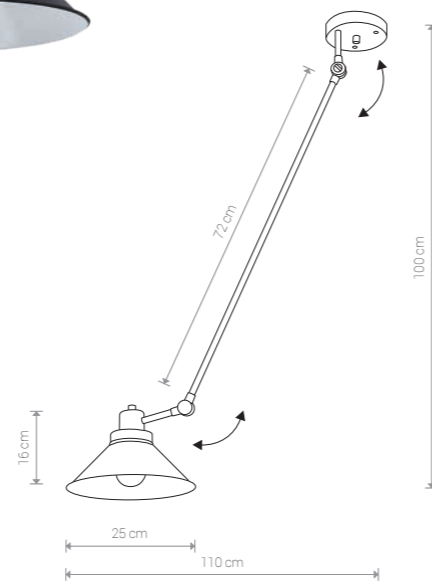

TECHNO

stal lakierowana / painted steel /
лакированная сталь

9144 ● BL/WH

Ⓢ 1×E27, max 60W

TECHNO 9142 BL/WH

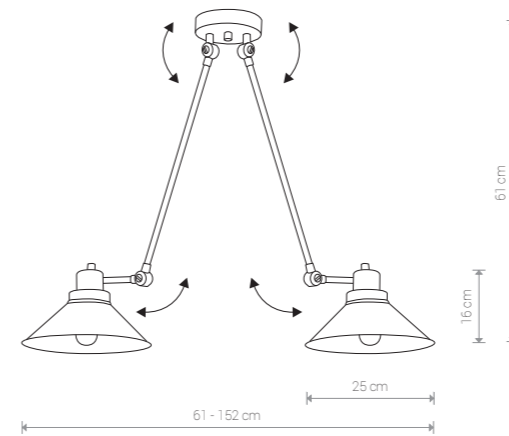

TECHNO

stal lakierowana / painted steel /
лакированная сталь

9143 ● BL/WH

Ⓢ 2×E27, max 60W

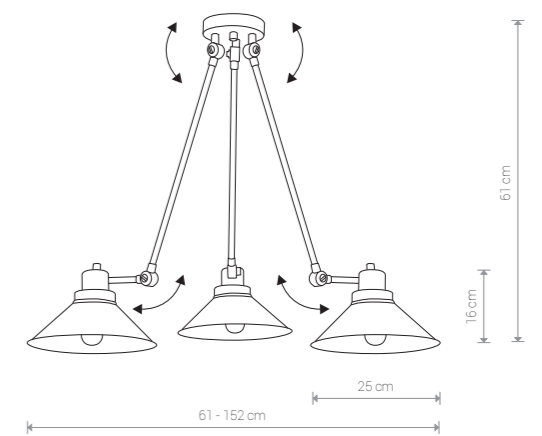

TECHNO

stal lakierowana / painted steel /
лакированная сталь

9142 ● BL/WH

Ⓢ 3×E27, max 60W



PANTOGRAPH 9126 BL/WH

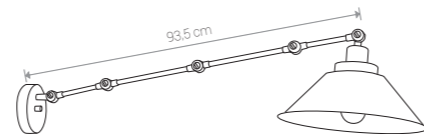
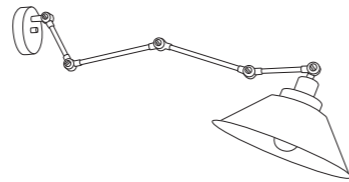
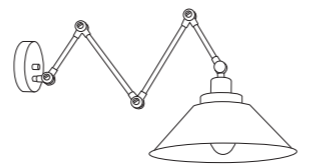
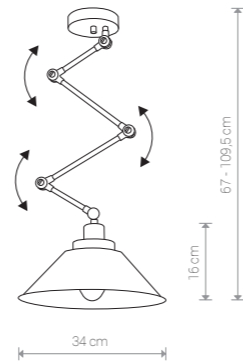

PANTOGRAPH 9126 BL/WH

PANTOGRAPH

stal lakierowana / painted steel / лакированная сталь

9126 ● BL/WH

Ⓛ 1×E27, max 60W



CRAFT 9150 BL/WH



CRAFT 9151 BL/WH

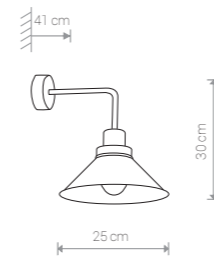

CRAFT

stal lakierowana / painted steel / лакированная сталь

9151 ● BL/WH

Ⓛ 1×E27, max 60W

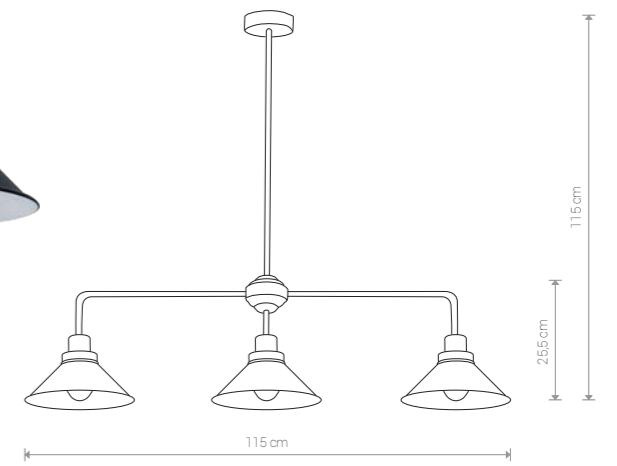

CRAFT

stal lakierowana / painted steel / лакированная сталь

9150 ● BL/WH

Ⓛ 3×E27, max 60W



CYCLON 8888 WH

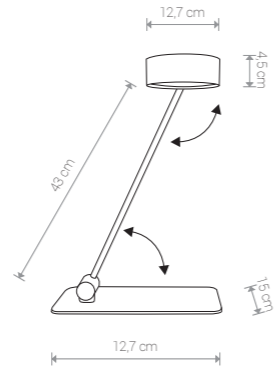

CYCLON

stal lakierowana, stal mosiądzowana /
painted steel, electroplated brass /
лакированная сталь, латунная сталь

8887 ● BL/G

10W LED

stal lakierowana / painted steel /
лакированная сталь

8886 ○ WH

10W LED

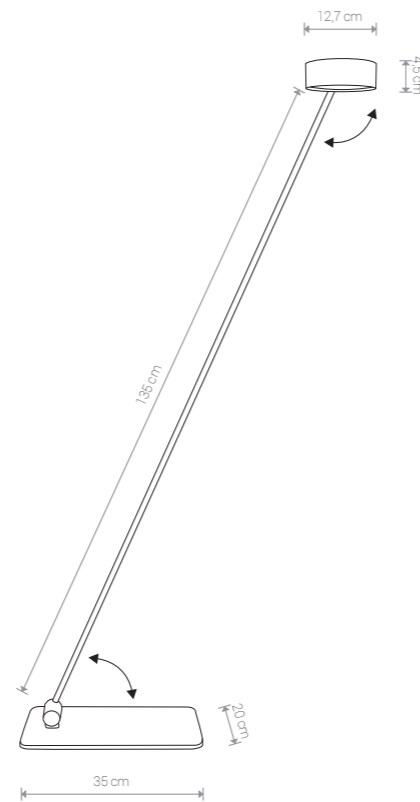

CYCLON

stal lakierowana, stal mosiądzowana /
painted steel, electroplated brass /
лакированная сталь, латунная сталь

8890 ● BL/G

10W LED

stal lakierowana / painted steel /
лакированная сталь

8888 ○ WH

10W LED



CYCLON 8894 BL/G

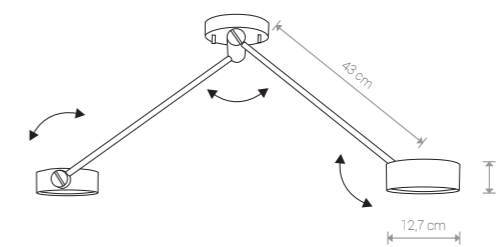

CYCLON

stal lakierowana, stal mosiądzowana /
painted steel, electroplated brass /
лакированная сталь, латунная сталь

8894 ● BL/G

2x10W LED

stal lakierowana / painted steel /
лакированная сталь

8893 ○ WH

2x10W LED



CYCLON 8892 BL/G

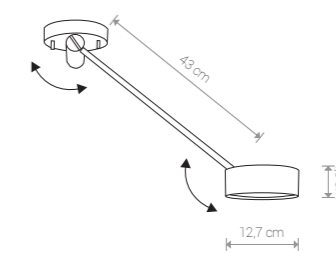

CYCLON

stal lakierowana, stal mosiądzowana /
painted steel, electroplated brass /
лакированная сталь, латунная сталь

8892 ● BL/G

10W LED

stal lakierowana / painted steel /
лакированная сталь

8891 ○ WH

10W LED

Item No.	INPUT POWER	COLOUR TEMP.	LUMINOUS FLUX	LUMINAIRE EFFICIENCY	COLOUR RENDERING INDEX (CRI ≥)	INPUT	LIFETIME
8892, 8891, 8887, 8886, 8890, 8888	10W LED	3000K	800 lm	80	80	~230V, 50Hz	50 000 h
8894, 8893	2x10W LED	3000K	2x800 lm	80	80	~230V, 50Hz	50 000 h

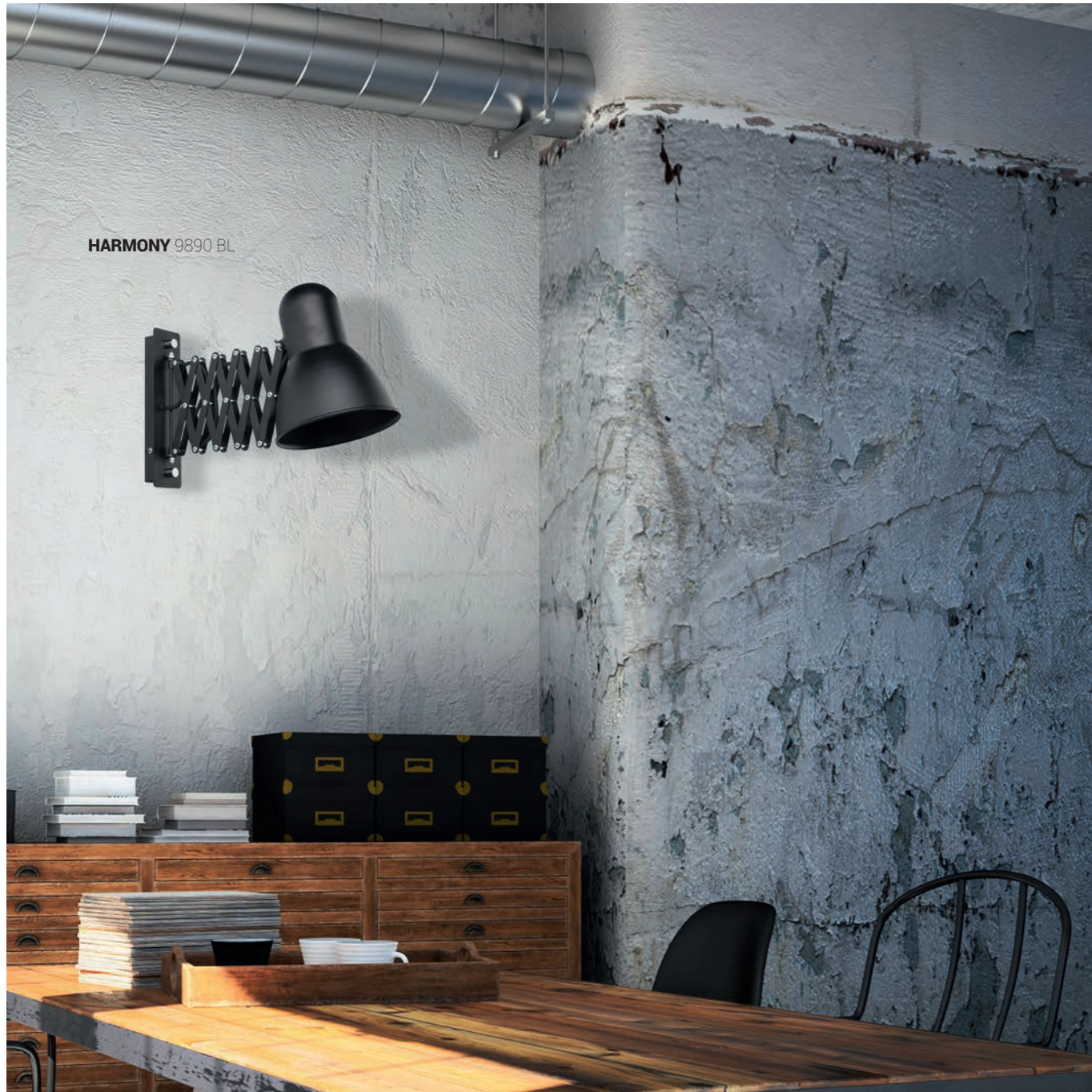

HARMONY 9890 BL



HARMONY 6870 WH



HARMONY 6871 WH

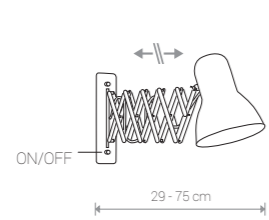

HARMONY

stal lakierowana / painted steel /
лакированная сталь

6868 ○ WH 9890 ● BL

1×E27, max 60W

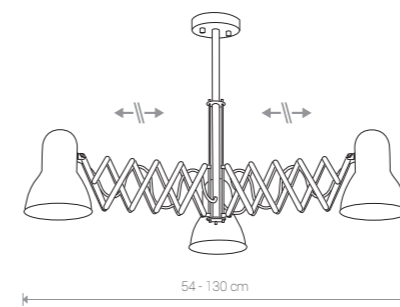

HARMONY

stal lakierowana / painted steel /
лакированная сталь

6870 ○ WH

3×E27, max 60W

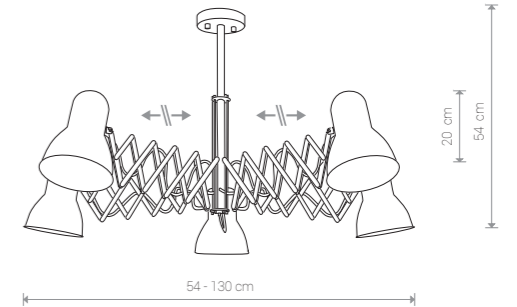

HARMONY

stal lakierowana / painted steel /
лакированная сталь

6871 ○ WH

5×E27, max 60W



INDUSTRIAL S 5647 CN/GY



INDUSTRIAL S 5526 GR/R

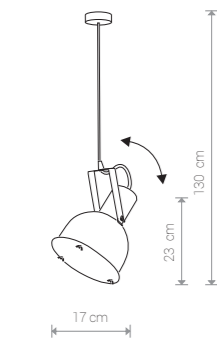

INDUSTRIAL S

stal lakierowana, szkło / painted steel, glass / лакированная сталь, стекло

5647 ● CN/GY 5527 ● GR/R

Ⓛ 1×E27, max 60W

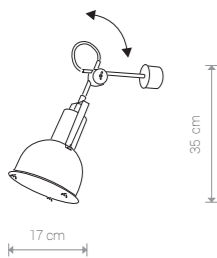

INDUSTRIAL S

stal lakierowana, szkło / painted steel, glass / лакированная сталь, стекло

5524 ● WH/R 5646 ● CN/GY 5526 ● GR/R

Ⓛ 1×E27, max 60W



INDUSTRIAL M 5530 GR/R



INDUSTRIAL L 5534 CN



INDUSTRIAL L 5532 WH

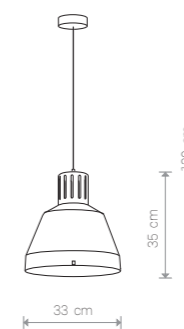

INDUSTRIAL M

stal lakierowana, szkło / painted steel, glass / лакированная сталь, стекло

5531 ● CN/GY 5530 ● GR/R

Ⓛ 1×E27, max 60W

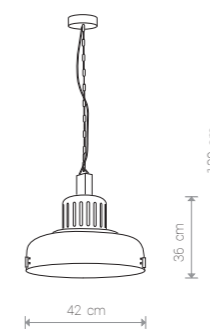

INDUSTRIAL L

stal lakierowana, szkło / painted steel, glass / лакированная сталь, стекло

5532 ○ WH 5534 ● CN 5533 ● GR

Ⓛ 3×E27, max 60W



HIGH-BAY 5067 BL



HIGH-BAY 5067 BL

HIGH-BAY 5066 WH

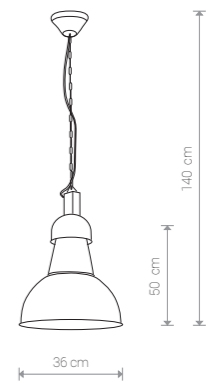

HIGH-BAY

stal lakierowana / painted steel / лакированная сталь

5066 ○ WH 5067 ● BL

Ⓛ 1×E27, max 60W

WORKS 6510 CN/GY



WORKS 6508 WH/R



WORKS 6613 BL

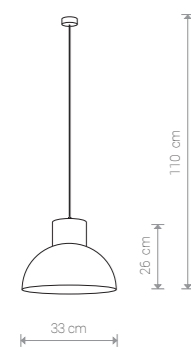

WORKS

stal lakierowana / painted steel / лакированная сталь

- 6612 ○ WH 6508 ◐ WH/R
- 6613 ● BL 6511 ◑ GR/R 6510 ● CN/GY

1×E27, max 60W

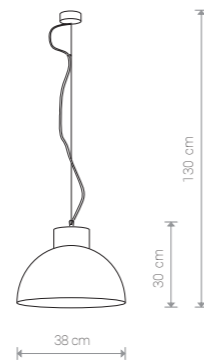

FACTORY

stal lakierowana, szkło / painted steel, glass / лакированная сталь, стекло

- 6928 ● CN

1×E27, max 60W



FACTORY 6928 CN



GARRET 6443 CHT/CO

GARRET 9247 CHT/CO



GARRET 6442 CHT/CO



GARRET 6444 CHT/CO

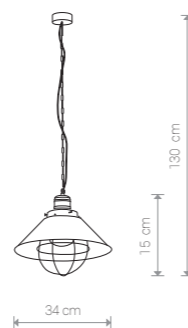

GARRET

stal lakierowana / painted steel /
лакированная сталь

6443 ● CHT/CO

Ⓛ 1×E27, max 60W

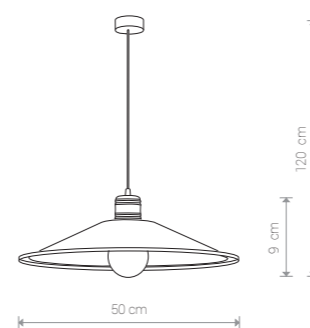

GARRET

stal lakierowana / painted steel /
лакированная сталь

6444 ● CHT/CO

Ⓛ 1×E27, max 60W

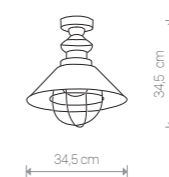

GARRET

stal lakierowana / painted steel /
лакированная сталь

9247 ● CHT/CO

Ⓛ 1×E27, max 60W

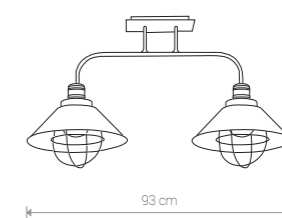

GARRET

stal lakierowana / painted steel /
лакированная сталь

6445 ● CHT/CO

Ⓛ 2×E27, max 60W

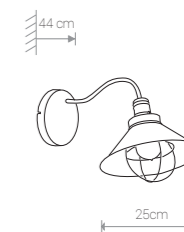

GARRET

stal lakierowana / painted steel /
лакированная сталь

6442 ● CHT/CO

Ⓛ 1×E27, max 60W

LOFT 5554 EC/CO



LOFT 5048 EC/CO



LOFT

stal lakierowana / painted steel / лакированная сталь

5665 TA/CO

1xE27, max 60W

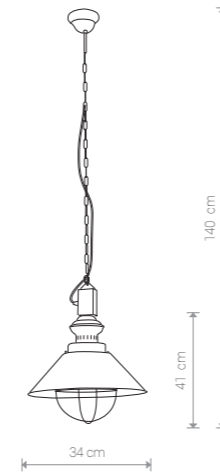

LOFT

stal lakierowana / painted steel / лакированная сталь

5053 TA/CO

1xE27, max 60W

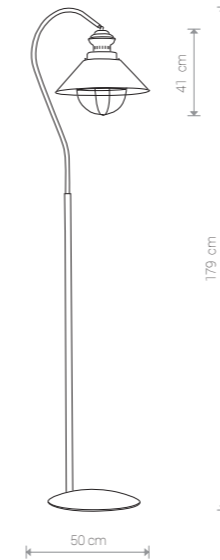

LOFT

stal lakierowana / painted steel / лакированная сталь

5056 TA/CO

1xE27, max 60W

LOFT 5056 TA/CO

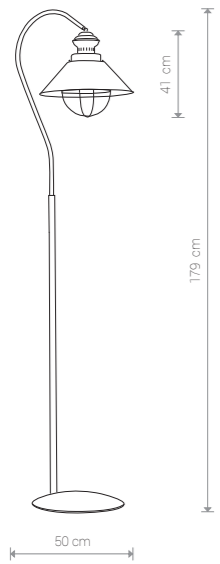

LOFT

stal lakierowana / painted steel / лакированная сталь

5052 EC/CO

1xE27, max 60W

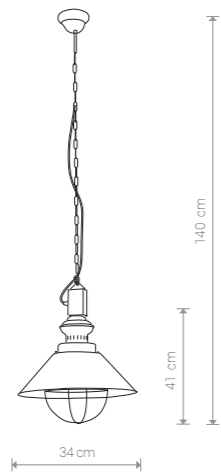

LOFT

stal lakierowana / painted steel / лакированная сталь

5048 EC/CO

1xE27, max 60W

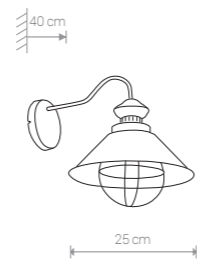

LOFT

stal lakierowana / painted steel / лакированная сталь

5554 EC/CO

1xE27, max 60W



LOFT 5058 CHT/CO

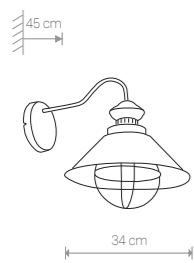

LOFT

stal lakierowana / painted steel / лакированная сталь

5058 CHT/CO

1x E27, max 60W



LOFT 5057 CHT/CO

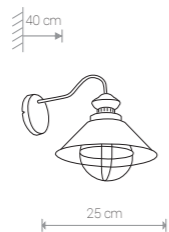

LOFT

stal lakierowana / painted steel / лакированная сталь

5057 CHT/CO

1x E27, max 60W

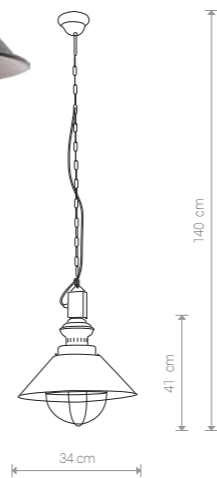

LOFT

stal lakierowana / painted steel / лакированная сталь

5057 CHT/CO

1x E27, max 60W



LOFT

stal lakierowana / painted steel / лакированная сталь

5060 CHT/CO

1x E27, max 60W

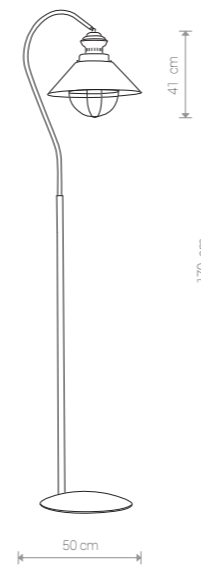

LOFT

stal lakierowana / painted steel / лакированная сталь

5061 CHT/CO

1x E27, max 60W



LOFT 5060 CHT/CO

LOFT 5061 CHT/CO





HEMISPHERE RUST L 6368 BR

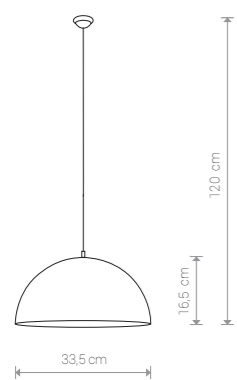

HEMISPHERE RUST S

stal lakierowana / painted steel / лакированная сталь

6367 ● BR

1×E27, max 60W

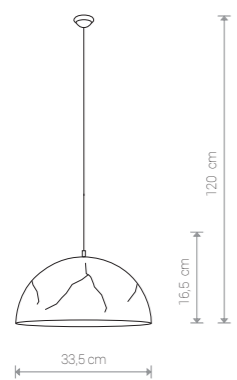

HEMISPHERE CRACKS S

stal lakierowana / painted steel / лакированная сталь

6370 ● BR

1×E27, max 60W

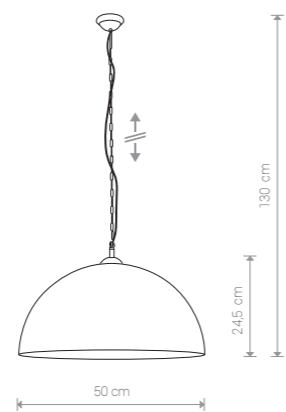

HEMISPHERE RUST L

stal lakierowana / painted steel / лакированная сталь

6368 ● BR

1×E27, max 60W

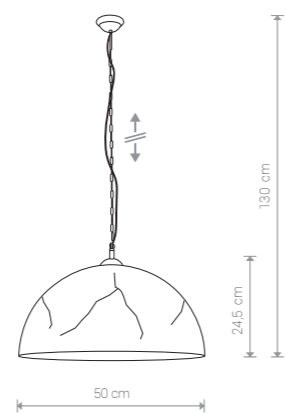

HEMISPHERE CRACKS L

stal lakierowana / painted steel / лакированная сталь

6371 ● BR

1×E27, max 60W



HEMISPHERE CRACKS S 6370 BR



HEMISPHERE L 6930 BL/SI

HEMISPHERE L 6931 WH/SI

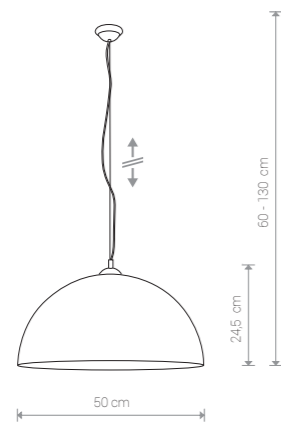

HEMISPHERE L

stal lakierowana / painted steel / лакированная сталь

6931 ● WH/SI 6930 ● BL/SI

1xE27, max 100W



HEMISPHERE S 4841 WH

HEMISPHERE L 5073 GY/WH

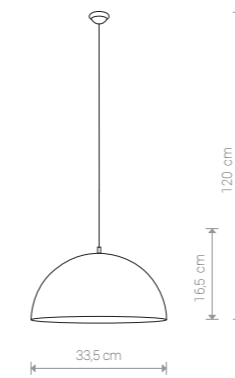

HEMISPHERE S

stal lakierowana / painted steel / лакированная сталь

4841 ○ WH 5074 ● GY/WH

1xE27, max 100W

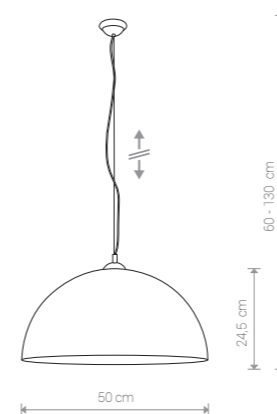

HEMISPHERE L

stal lakierowana / painted steel / лакированная сталь

4856 ○ WH 5073 ● GY/WH

1xE27, max 100W

HEMISPHERE L 4843 BL/WH



HEMISPHERE L 4844 BL/G



HEMISPHERE S 4893 WH/G



HEMISPHERE CEILING 6934 BL/G



HEMISPHERE CEILING 6932 WH



HEMISPHERE CEILING 6933 WH/G

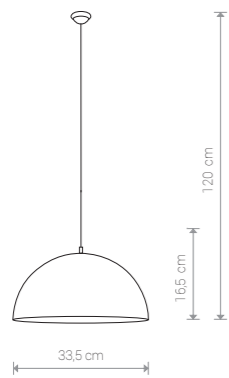

HEMISPHERE S

stal lakierowana / painted steel / лакированная сталь

4838 ● BL/WH 4840 ● BL/G 4893 ● WH/G

1x E27, max 100W

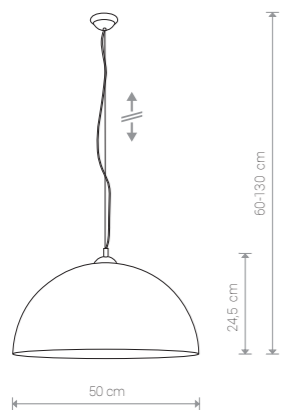

HEMISPHERE L

stal lakierowana / painted steel / лакированная сталь

4843 ● BL/WH 4844 ● BL/G 4842 ● WH/G

1x E27, max 100W

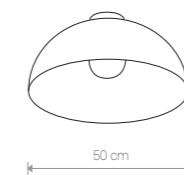

HEMISPHERE CEILING

stal lakierowana / painted steel / лакированная сталь

6932 ○ WH 6934 ● BL/G 6933 ● WH/G

1x E27, max 100W



HEMISPHERE HIT S 6777 BL/G

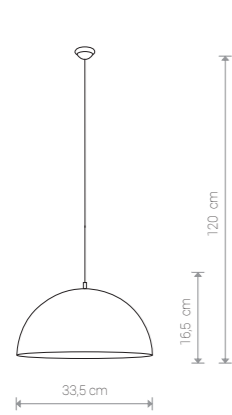

HEMISPHERE HIT S

stal lakierowana / painted steel / лакированная сталь

6777 ● BL/G

Ⓛ 1×E27, max 100W

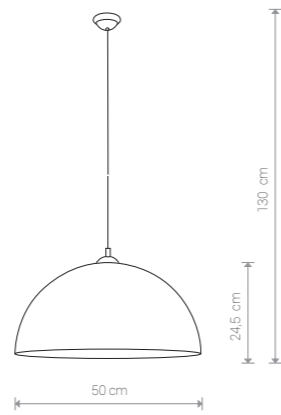

HEMISPHERE HIT L

stal lakierowana / painted steel / лакированная сталь

6778 ● BL/G

Ⓛ 1×E27, max 100W



BOWL L 5077 BL/WH

BOWL M 5083 WH

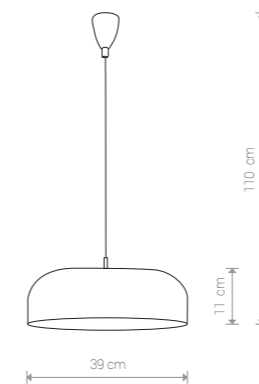

BOWL M

stal lakierowana, szkło / painted steel, glass / лакированная сталь, стекло

5078 ● BL/WH 5083 ○ WH

Ⓛ 3×E27, max 60W

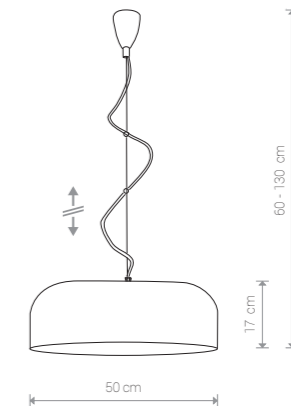

BOWL L

stal lakierowana, szkło / painted steel, glass / лакированная сталь, стекло

5077 ● BL/WH 5082 ○ WH

Ⓛ 3×E27, max 60W



PLANT 9381 BL



PLANT 9382 WH

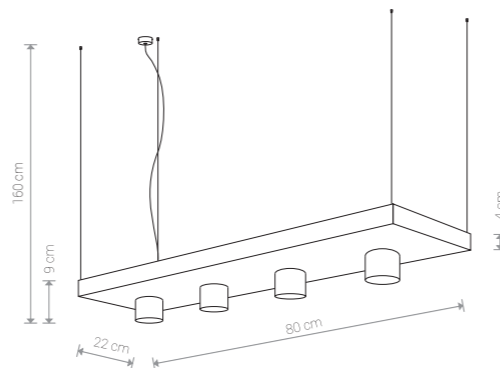

PLANT

stal lakierowana / painted steel / лакированная сталь

9382 ○ WH 9381 ● BL

Ⓧ 4xGU10, max 35W



DIAMOND 6344 BL

DIAMOND 8801 WH

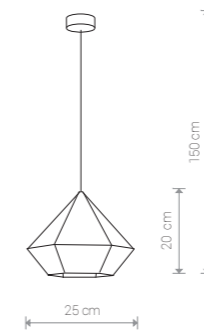

DIAMOND

stal lakierowana / painted steel / лакированная сталь

6344 ● BL 8801 ○ WH

Ⓧ 1xE27, max 60W



BUBBLE 6142 WH

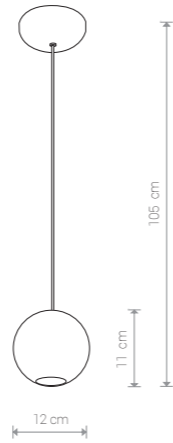

BUBBLE

stal lakierowana / painted steel /
лакированная сталь

6142 ○ WH 6031 ● BL

Ⓛ 1×GU10, max 35W

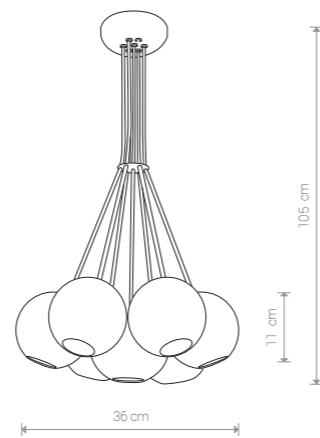

BUBBLE

stal lakierowana / painted steel /
лакированная сталь

6144 ○ WH 6033 ● BL

Ⓛ 7×GU10, max 35W

BUBBLE 6144 WH



BUBBLE 6030 BL

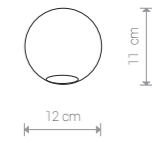

BUBBLE

stal lakierowana / painted steel /
лакированная сталь

6030 ● BL 6023 ○ WH

Ⓛ 1×GU10, max 35W

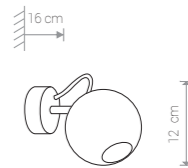

BUBBLE

stal lakierowana / painted steel /
лакированная сталь

6035 ● BL 6145 ○ WH

Ⓛ 1×GU10, max 35W

BUBBLE 6035 BL

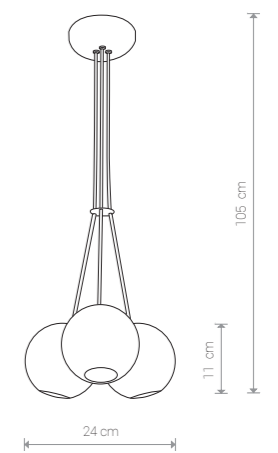

BUBBLE

stal lakierowana / painted steel /
лакированная сталь

6032 ● BL 6143 ○ WH

Ⓛ 3×GU10, max 35W

BUBBLE 6032 BL



BALL 6587 BL/G



BALL 6601 WH



BALL 6583 BL/WH

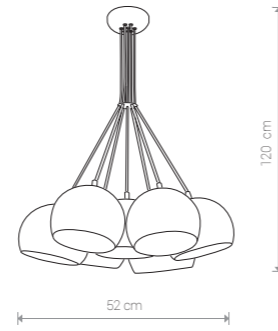
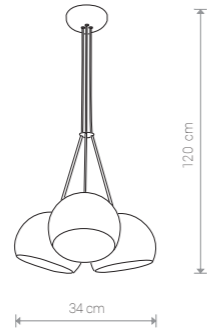
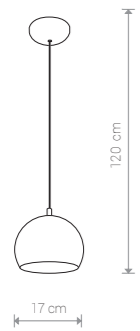

BALL

stal lakierowana / painted steel /
лакированная сталь

6598 ○ WH 6583 ● BL/WH

6602 ● WH/G 6586 ● BL/G

Ⓛ 1×GU10, max 35W

BALL

stal lakierowana / painted steel /
лакированная сталь

6600 ○ WH 6584 ● BL/WH

6603 ● WH/G 6587 ● BL/G

Ⓛ 3×GU10, max 35W

BALL

stal lakierowana / painted steel /
лакированная сталь

6601 ○ WH 6585 ● BL/WH

6604 ● WH/G 6588 ● BL/G

Ⓛ 7×GU10, max 35W



PETRA 9798 CO

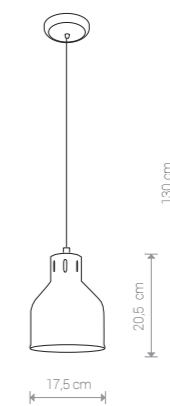

PETRA

stal lakierowana / painted steel /
лакированная сталь

9798 ● CO

Ⓛ 1×E27, max 60W



CABLE BLACK 9746 CO

CABLE BLACK 9747 CO

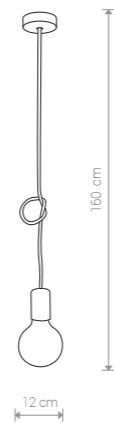

CABLE BLACK/
COOPER

kabel w oplocie / braided cable /
кабель в оплетке

9747 ● CO

Ⓧ 1×E27, max 60W



CABLE BLACK/
COOPER

kabel w oplocie / braided cable /
кабель в оплетке

9746 ● CO

Ⓧ 7×E27, max 60W



TULUM 9691 CN



TULUM

beton, kabel w oplocie / concrete, braided cable /
бетон, кабель в оплетке

9691 ● CN

Ⓧ 1×E27, max 60W



TULUM 9692 CN



TULUM

beton, kabel w oplocie / concrete, braided cable /
бетон, кабель в оплетке

9692 ● CN

Ⓧ 1×E27, max 60W



SILICONE 6403 WH



SILICONE 6404 BL



SILICONE

silikon / silicone / силикон

6404 ● BL 6403 ○ WH

Ⓧ 1×E27, max 60W

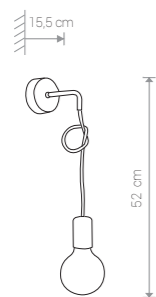

SIMPLE

stal lakierowana / painted steel /
лакированная сталь

6973 ● BL

1×E27, max 60W

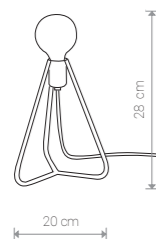

SIMPLE

stal lakierowana / painted steel /
лакированная сталь

6975 ● BL

1×E27, max 60W

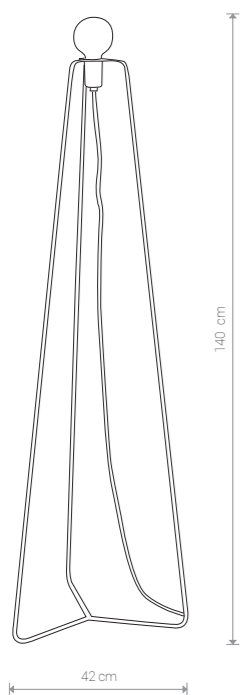

SIMPLE

stal lakierowana / painted steel /
лакированная сталь

6974 ● BL

1×E27, max 60W



SIMPLE 6973 BL



SIMPLE 6974 BL

SIMPLE 6975 BL



SPIDER 6786 R



SPIDER 9744 WH

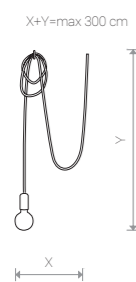

SPIDER

kabel w oplocie / braided cable /
кабель в оплетке

9745 ○ WH

Ⓢ 1×E27, max 60W

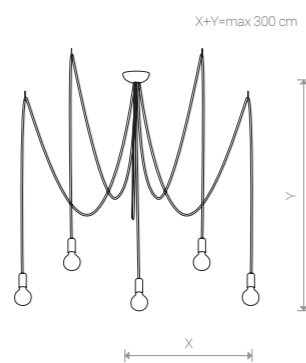

SPIDER

kabel w oplocie / braided cable /
кабель в оплетке

9744 ○ WH 6790 ● R

Ⓢ 5×E27, max 60W

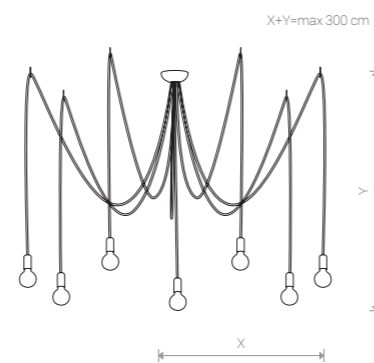

SPIDER

kabel w oplocie / braided cable /
кабель в оплетке

9743 ○ WH 6786 ● R

Ⓢ 7×E27, max 60W

SPIDER 6794 GY

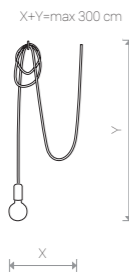
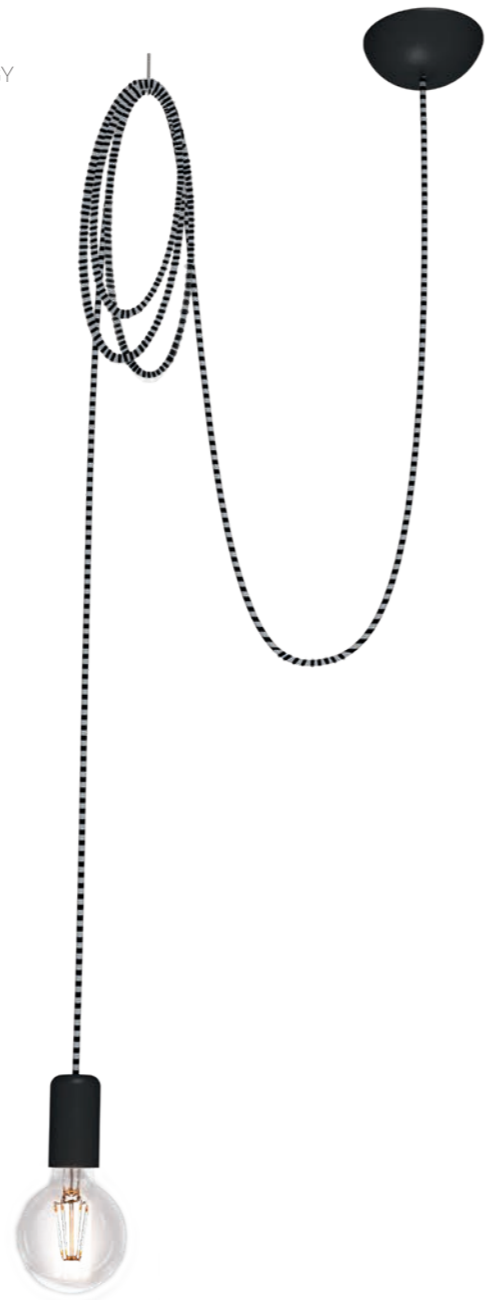

SPIDER

kabel w oplocie / braided cable /
кабель в оплетке

6792 ● BL 6794 ● GY

① 1×E27, max 60W

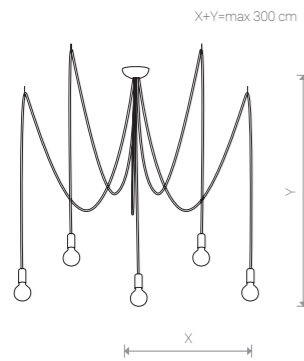

SPIDER

kabel w oplocie / braided cable /
кабель в оплетке

6788 ● BL 6791 ● GY

① 5×E27, max 60W

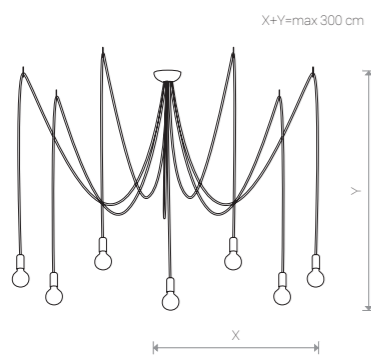

SPIDER

kabel w oplocie / braided cable /
кабель в оплетке

6785 ● BL 6787 ● GY

① 7×E27, max 60W



SPIDER 6785 BL



SPIDER 6791 GY



FLEX 9771 WH



FLEX 9774 WH

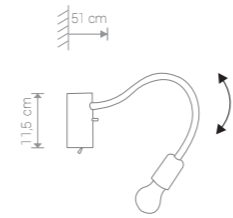

FLEX

peszel, stal lakierowana / protective pipe, painted steel /
кабель-канал, лакированная сталь

9774 ○ WH 9768 ● BL

Ⓢ 1×E27, max 60W



FLEX 9770 BL

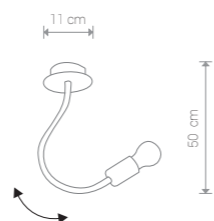

FLEX

peszel, stal lakierowana / protective pipe, painted steel /
кабель-канал, лакированная сталь

9775 ○ WH 9770 ● BL

Ⓢ 1×E27, max 60W

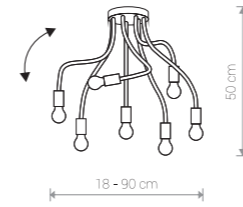

FLEX

peszel, stal lakierowana / protective pipe, painted steel /
кабель-канал, лакированная сталь

9274 ○ WH 9273 ● BL

Ⓢ 7×E27, max 60W

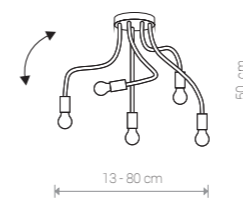

FLEX

peszel, stal lakierowana / protective pipe, painted steel /
кабель-канал, лакированная сталь

9772 ○ WH 9766 ● BL

Ⓢ 5×E27, max 60W

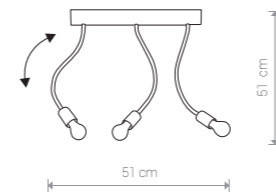

FLEX

peszel, stal lakierowana / protective pipe, painted steel /
кабель-канал, лакированная сталь

9773 ○ WH 9767 ● BL

Ⓢ 3×E27, max 60W

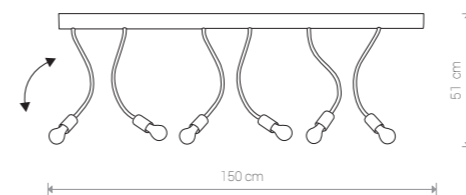

FLEX

peszel, stal lakierowana / protective pipe, painted steel /
кабель-канал, лакированная сталь

9771 ○ WH 9765 ● BL

Ⓢ 6×E27, max 60W



FLEX 9273 BL



VOLCANO 6852 CN

LAVA 6855 CN



VOLCANO 6853 CN

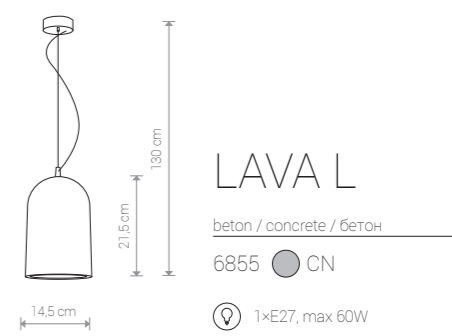
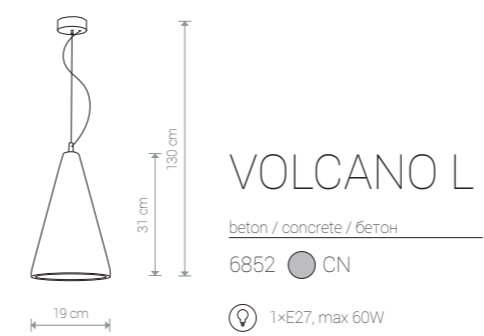
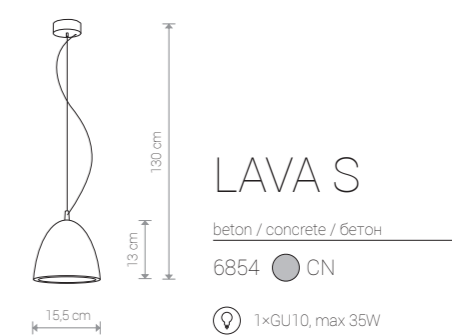
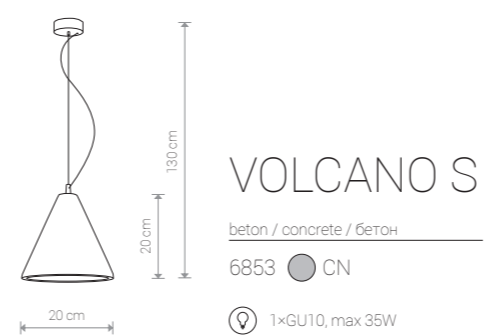

GEOMETRIC 9697 CN



GEOMETRIC 9696 CN



GEOMETRIC 9695 CN

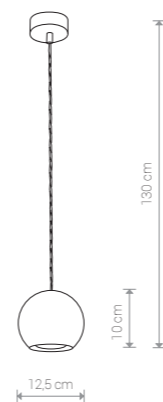

GEOMETRIC

beton, kabel w oplocie / concrete, braided cable / бетон, кабель в оплетке

9696 ● CN

1xGU10, max 35W

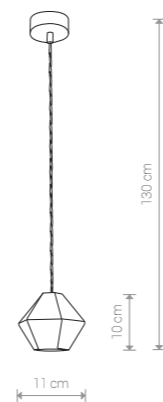

GEOMETRIC

beton, kabel w oplocie / concrete, braided cable / бетон, кабель в оплетке

9697 ● CN

1xGU10, max 35W

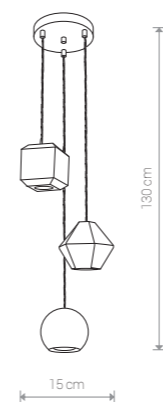

GEOMETRIC

beton, kabel w oplocie / concrete, braided cable / бетон, кабель в оплетке

9695 ● CN

3xGU10, max 35W

GYPSUM 6856 GY

GYPSUM 6858 GY



GYPSUM 6857 GY

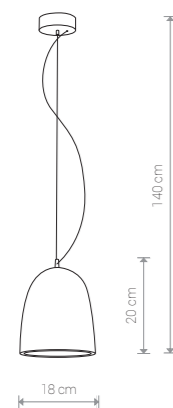

GYPSUM

gips / gypsum / гипс

6856 ● GY

1x E27, max 60W

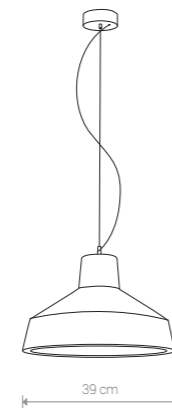

GYPSUM

gips / gypsum / гипс

6858 ● GY

1x E27, max 60W

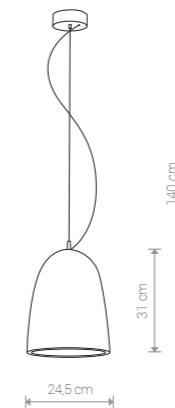

GYPSUM

gips / gypsum / гипс

6857 ● GY

1x E27, max 60W



STONE TRAVERTINE 7014 GR

STONE GRAY 7015 GR

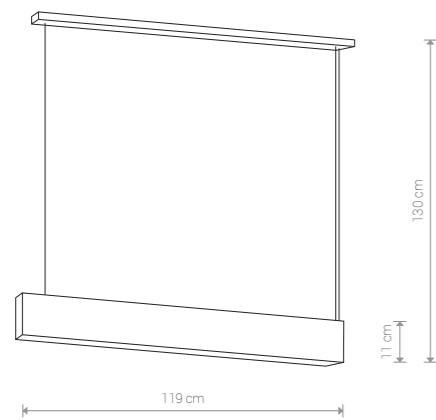

STONE GRAY

tworzywo sztuczne / plastic / пластик

7015 ● GR

⊖ 1×T5, 54W

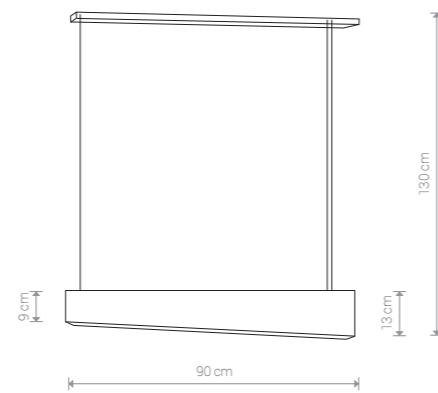

STONE TRAVERTINE

tworzywo sztuczne / plastic / пластик

7014 ● GR

⊖ 1×T5, 39W



STONE TRAVERTINE 7014 GR

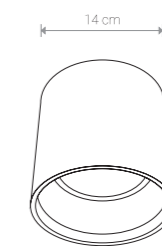

SHY
beton / concrete / бетон
9393 ● CN
1×GU10, ES111, max 75W



SHY
beton / concrete / бетон
9390 ● CN
1×GU10, max 35W

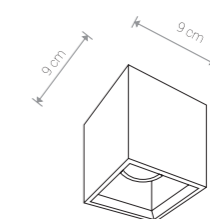

BOLD
beton / concrete / бетон
9388 ● CN
1×GU10, max 35W

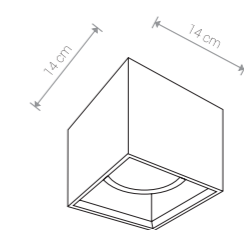

BOLD
beton / concrete / бетон
9392 ● CN
1×GU10, ES111, max 75W



ARCH 9633 GY

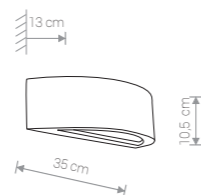

ARCH

gips, szkło / gypsum, glass / гипс, стекло

9633 ● GY

1×E27, max 60W



ARCH 9720 GY

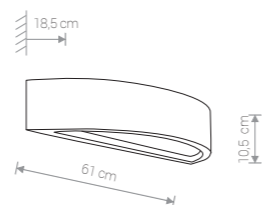

ARCH

gips, szkło / gypsum, glass / гипс, стекло

9720 ● GY

2×E27, max 60W



SOLID 9721 CN

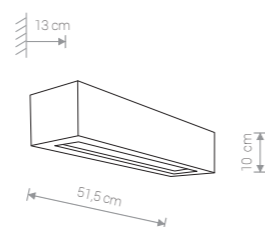

SOLID

beton, szkło / concrete, glass / бетон, стекло

9721 ● CN

2×E27, max 60W



SOLID 9721 CN

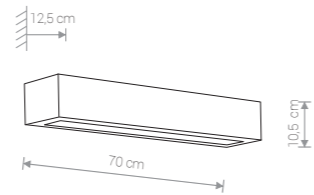

GIPSY PROSTOKAŁ L

gips, szkło / plaster, glass / гипс, стекло

2208 ● GY

Ⓛ 2xE27, max 60W

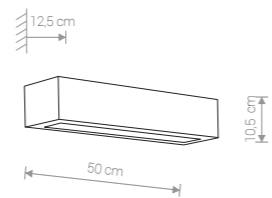

GIPSY PROSTOKAŁ M

gips, szkło / plaster, glass / гипс, стекло

2207 ● GY

Ⓛ 2xE27, max 60W

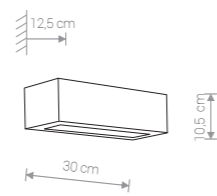

GIPSY PROSTOKAŁ S

gips, szkło / plaster, glass / гипс, стекло

2206 ● GY

Ⓛ 1xE27, max 60W

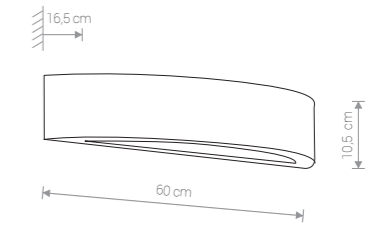

GIPSY ŁUK L

gips, szkło / plaster, glass / гипс, стекло

2411 ● GY

Ⓛ 2xE27, max 60W

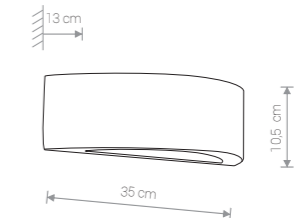

GIPSY ŁUK S

gips, szkło / plaster, glass / гипс, стекло

2410 ● GY

Ⓛ 1xE27, max 60W

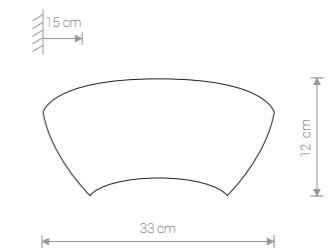

GIPSY MOON S

gips, szkło / plaster, glass / гипс, стекло

5451 ● GY

Ⓛ 1xE27, max 60W

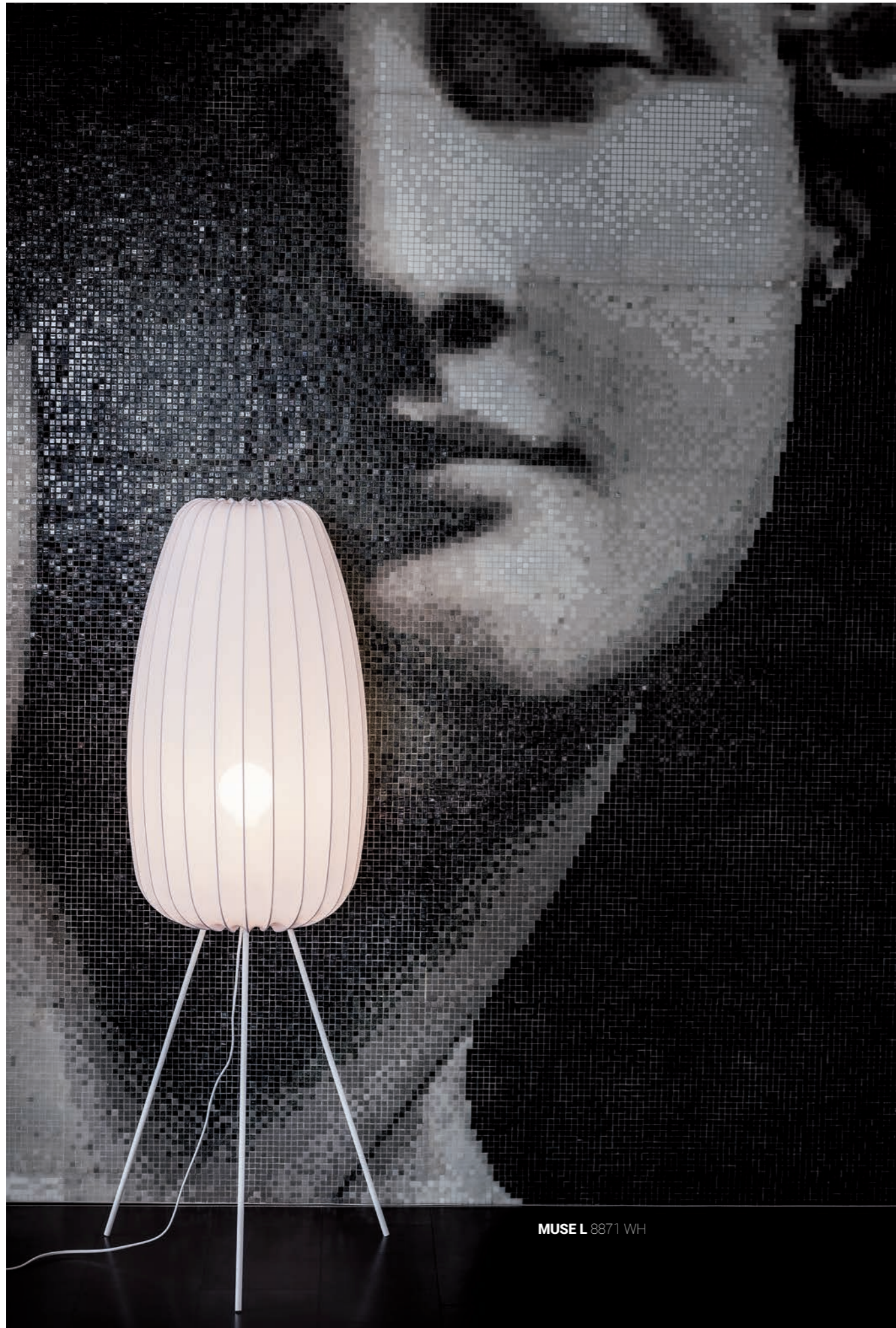

MUSE L 8871 WH

MUSE L 8871 WH



MUSE M 8872 WH



MUSE M

lycra, stal lakierowana / lycra, painted steel /
лайкра, лакированная сталь

8872 ○ WH

1×E27, LED / max 25W

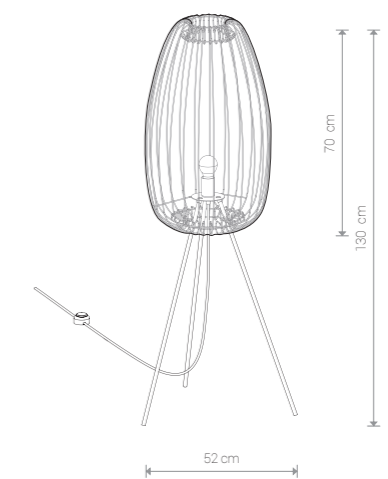

MUSE L

lycra, stal lakierowana / lycra, painted steel /
лайкра, лакированная сталь

8871 ○ WH

1×E27, LED / max 25W

FORM M 9673 WH



FORM L 9672 WH

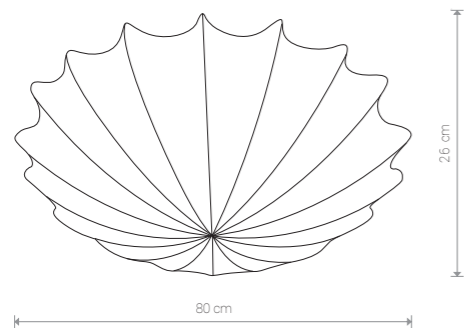

FORM L

lycra, stal lakierowana / lycra, painted steel / лайкра, лакированная сталь

9672 ○ WH

4×E27, LED / max 25W

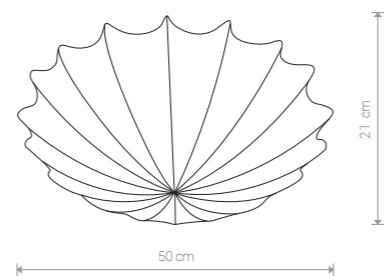

FORM M

lycra, stal lakierowana / lycra, painted steel / лайкра, лакированная сталь

9673 ○ WH

2×E27, LED / max 25W



MIST 8944 WH



MIST 8943 WH



MIST 8942 WH

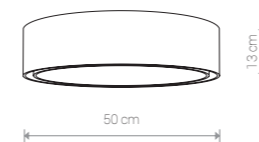

MIST

abażur, papier PVC, stal lakierowana / shade, paper PVC, painted steel / абажур, бумага PCV, лакированная сталь

8943 ○ WH

3×E27, LED / max 25W

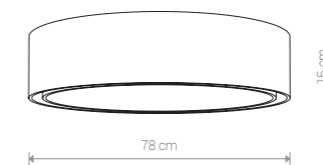

MIST

abażur, papier PVC, stal lakierowana / shade, paper PVC, painted steel / абажур, бумага PCV, лакированная сталь

8944 ○ WH

7×E27, LED / max 25W

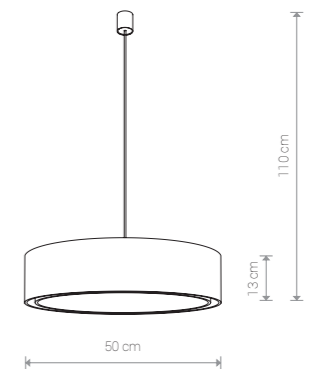

MIST

abażur, papier PVC, stal lakierowana / shade, paper PVC, painted steel / абажур, бумага PCV, лакированная сталь

8942 ○ WH

3×E27, LED / max 25W



LAGUNA 8962 EC



LAGUNA 8957 EC



LAGUNA 8954 EC



LAGUNA 8951 EC

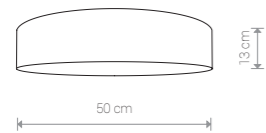

LAGUNA

abażur, papier PVC, stal lakierowana /
shade, paper PCV, painted steel /
абажур, бумага PCV, лакированная сталь

8954 ● EC

3×E27, LED / max 25W

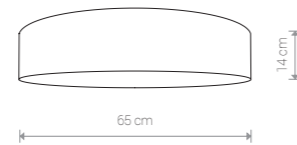

LAGUNA

abażur, papier PVC, stal lakierowana /
shade, paper PCV, painted steel /
абажур, бумага PCV, лакированная сталь

8957 ● EC

4×E27, LED / max 25W

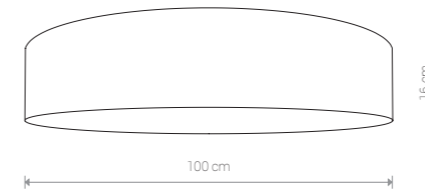

LAGUNA

abażur, papier PVC, stal lakierowana /
shade, paper PCV, painted steel /
абажур, бумага PCV, лакированная сталь

8962 ● EC

9×E27, LED / max 25W

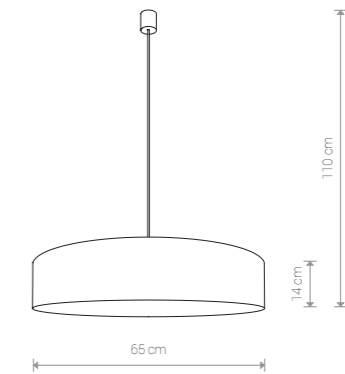

LAGUNA

abażur, papier PVC, stal lakierowana /
shade, paper PCV, painted steel /
абажур, бумага PCV, лакированная сталь

8951 ● EC

3×E27, LED / max 25W



TURDA 8952 WH/SI



TURDA 8958 WH/SI



TURDA 8946 GY/SI



TURDA 8947 GY/SI

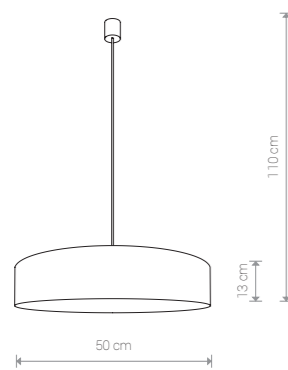

TURDA

abażur, papier PVC, stal lakierowana /
shade, paper PCV, painted steel /
абажур, бумага PCV, лакированная сталь

8945 ● WH/SI

3×E27, LED / max 25W

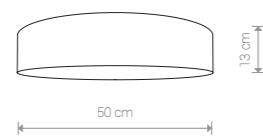

TURDA

abażur, papier PVC, stal lakierowana /
shade, paper PCV, painted steel /
абажур, бумага PCV, лакированная сталь

8952 ● WH/SI

3×E27, LED / max 25W

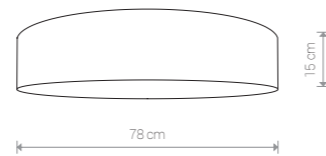

TURDA

abażur, papier PVC, stal lakierowana /
shade, paper PCV, painted steel /
абажур, бумага PCV, лакированная сталь

8958 ● WH/SI

7×E27, LED / max 25W

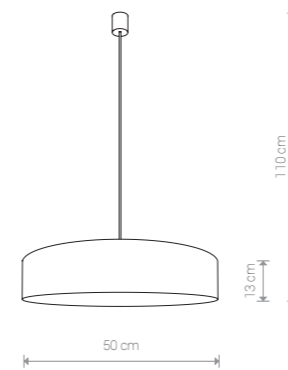

TURDA

abażur, papier PVC, stal lakierowana /
shade, paper PCV, painted steel /
абажур, бумага PCV, лакированная сталь

8946 ● GY/SI

3×E27, LED / max 25W

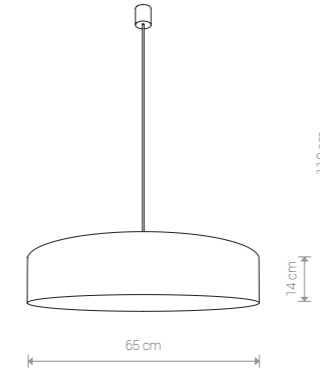

TURDA

abażur, papier PVC, stal lakierowana /
shade, paper PCV, painted steel /
абажур, бумага PCV, лакированная сталь

8947 ● GY/SI

3×E27, LED / max 25W

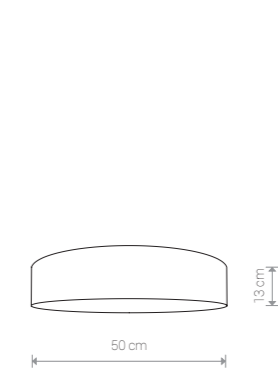

TURDA

abażur, papier PVC, stal lakierowana /
shade, paper PCV, painted steel /
абажур, бумага PCV, лакированная сталь

8953 ● GY/SI

3×E27, LED / max 25W

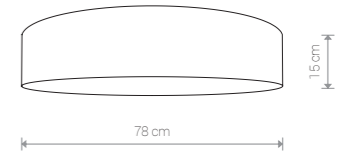

TURDA

abażur, papier PVC, stal lakierowana /
shade, paper PCV, painted steel /
абажур, бумага PCV, лакированная сталь

8960 ● GY/SI

7×E27, LED / max 25W



TURDA 8955 G



TURDA 8802 G

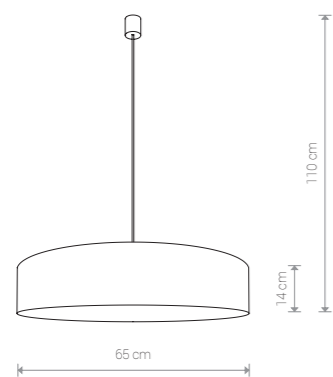

TURDA

abażur, papier PVC, stal lakierowana /
shade, paper PCV, painted steel /
абажур, бумага PCV, лакированная сталь

8950 ● G

3×E27, LED / max 25W

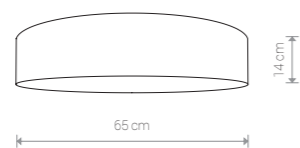

TURDA

abażur, papier PVC, stal lakierowana /
shade, paper PCV, painted steel /
абажур, бумага PCV, лакированная сталь

8955 ● G

4×E27, LED / max 25W

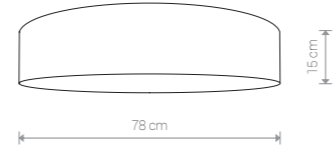

TURDA

abażur, papier PVC, stal lakierowana /
shade, paper PCV, painted steel /
абажур, бумага PCV, лакированная сталь

8802 ● G

7×E27, LED / max 25W



TURDA 8950 G

CROCO 8948 GR



CROCO 8956 GR



CROCO 8961 GR

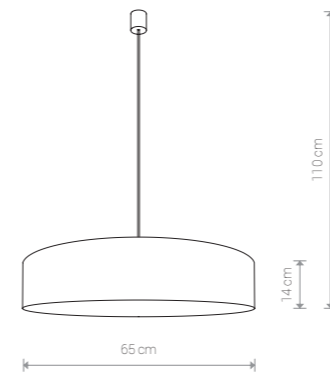

CROCO

abazur, papier PVC, stal lakierowana /
shade, paper PCV, painted steel /
абажур, бумага PCV, лакированная сталь

8948 ● GR

3×E27, LED / max 25W

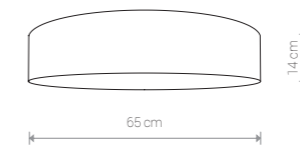

CROCO

abazur, papier PVC, stal lakierowana /
shade, paper PCV, painted steel /
абажур, бумага PCV, лакированная сталь

8956 ● GR

4×E27, LED / max 25W

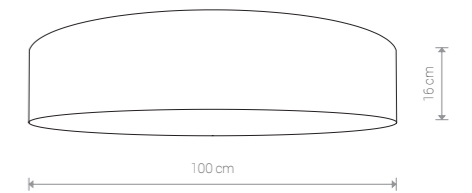

CROCO

abazur, papier PVC, stal lakierowana /
shade, paper PCV, painted steel /
абажур, бумага PCV, лакированная сталь

8961 ● GR

9×E27, LED / max 25W

CAMERON 9605 WH

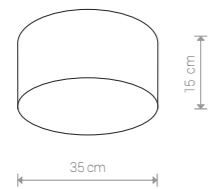

CAMERON

abažur, papier PVC / shade, paper PCV /
абажур, бумага PCV

9605 ○ WH

ⓧ 2×E27, LED / ⓧ max 25W



CAMERON 9685 WH

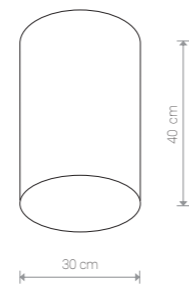

CAMERON

abažur, papier PVC / shade, paper PCV /
абажур, бумага PCV

9685 ○ WH

ⓧ 1×E27, LED / ⓧ max 25W



CAMERON 9683 GY

CAMERON 9681 TA

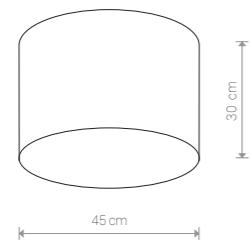

CAMERON

abažur, papier PVC / shade, paper PCV /
абажур, бумага PCV

9684 ○ WH

ⓧ 3×E27, LED / ⓧ max 25W

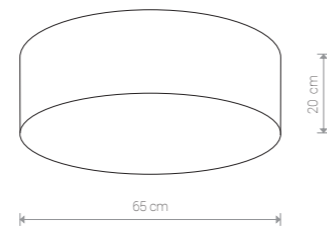

CAMERON

abažur, papier PVC / shade, paper PCV /
абажур, бумага PCV

9606 ○ WH

ⓧ 4×E27, LED / ⓧ max 25W

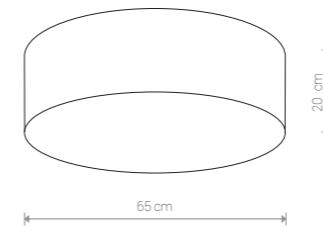

CAMERON

abažur, papier PVC / shade, paper PCV /
абажур, бумага PCV

9681 ● TA 9682 ● GY

ⓧ 4×E27, LED / ⓧ max 25W

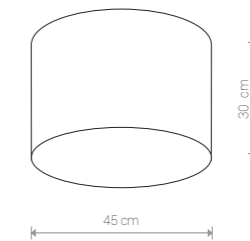

CAMERON

abažur, papier PVC / shade, paper PCV /
абажур, бумага PCV

9688 ● TA 9683 ● GY

ⓧ 3×E27, LED / ⓧ max 25W

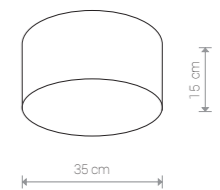

CAMERON

abažur, papier PVC / shade, paper PCV /
абажур, бумага PCV

9686 ● TA 9687 ● GY

ⓧ 2×E27, LED / ⓧ max 25W



ALEHANDRO 55 5353 BL



ALEHANDRO 55 5344 WH

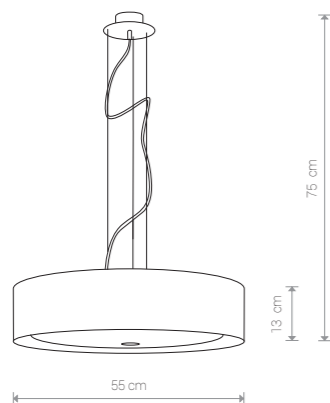

ALEHANDRO 55

abażur, stal chromowana, szkło / shade, electroplated steel, glass /
абажур, хромированная сталь, стекло

5345 ○ WH 5353 ● BL

Ⓧ 3×E27, max 60W

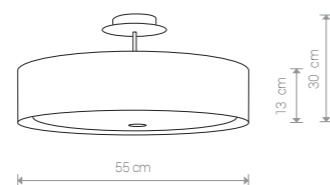

ALEHANDRO 55

abażur, stal chromowana, szkło / shade, electroplated steel, glass /
абажур, хромированная сталь, стекло

5344 ○ WH 5352 ● BL

Ⓧ 3×E27, max 60W

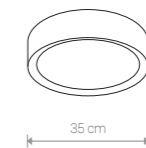

ALEHANDRO 35

abażur, szkło / shade, glass /

абажур, стекло

5270 ○ WH 5347 ● BL

Ⓧ 2×E27, max 60W

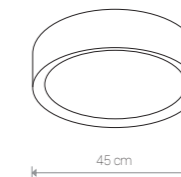

ALEHANDRO 45

abażur, szkło / shade, glass /

абажур, стекло

5271 ○ WH 5348 ● BL

Ⓧ 3×E27, max 60W

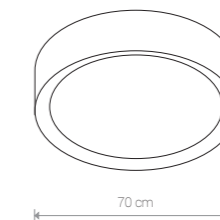

ALEHANDRO 70

abażur, szkło / shade, glass /

абажур, стекло

5288 ○ WH 5350 ● BL

Ⓧ 7×E27, max 60W

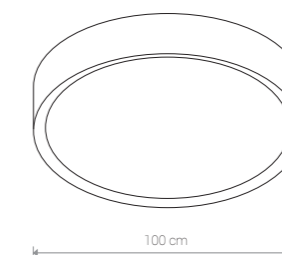

ALEHANDRO 100

abażur, szkło / shade, glass /

абажур, стекло

5343 ○ WH 5351 ● BL

Ⓧ 9×E27, max 60W

ALEHANDRO LED 100

abażur, szkło / shade, glass /

абажур, стекло

5286 ○ WH 5287 ● BL

Ⓧ 9×E27, max 60W
200×0,08W LED white included



VIVIANE 6772 WH



VIVIANE 6773 GY



VIVIANE 6390 BL

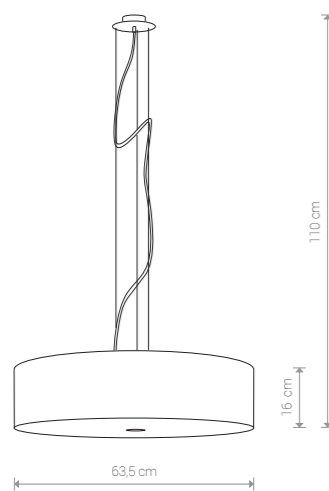

VIVIANE

abażur, stal chromowana, szkło / shade, electroplated steel, glass /
 абажур, хромированная сталь, стекло

6772 ○ WH 6773 ● GY 6774 ● BL

Ⓧ 3×E27, max 60W

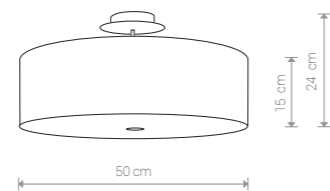

VIVIANE

abażur, stal chromowana, szkło / shade, electroplated steel, glass /
 абажур, хромированная сталь, стекло

6391 ○ WH 6532 ● GY 6390 ● BL

Ⓧ 3×E27, max 60W



BOAT 6310 GY



BOAT 6623 WH

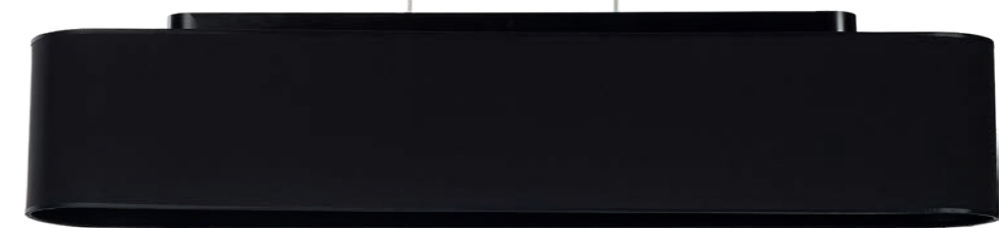

BOAT 6308 BL

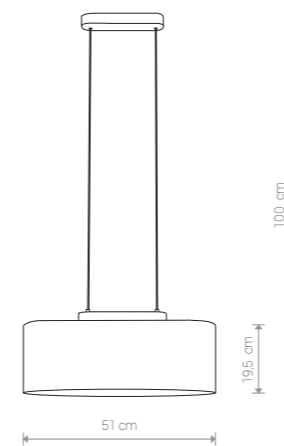

BOAT

drewno, abażur / wood, shade /
 дерево, абажур

6623 ○ WH 6310 ● GY

Ⓧ 2×E27, max 60W

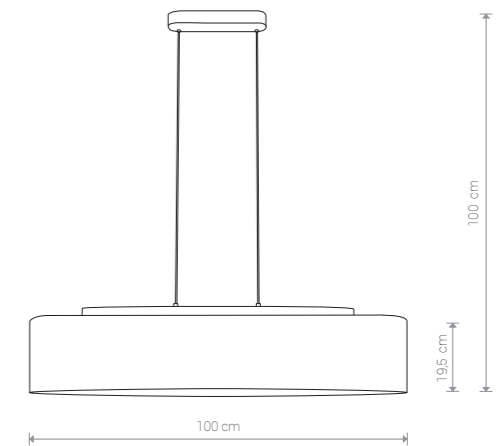

BOAT

drewno, abażur / wood, shade /
 дерево, абажур

6624 ○ WH 6311 ● GY 6308 ● BL

Ⓧ 4×E27, max 60W



ALICE 9084 BL/G



ALICE 9091 BL/G



ALICE 3473 BR/WH

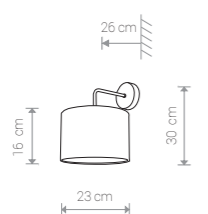

ALICE

abażur, stal lakierowana / shade, painted steel /
абажур, лакированная сталь

9084 ● BL/G 9082 ● BR/WH

1×E27, max 60W

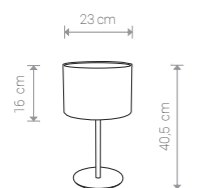

ALICE

abażur, stal lakierowana / shade, painted steel /
абажур, лакированная сталь

9091 ● BL/G 9087 ● BR/WH

1×E27, max 60W

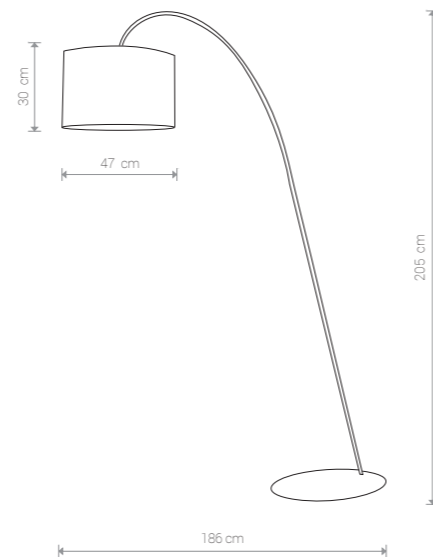

ALICE

abażur, stal lakierowana / shade, painted steel /
абажур, лакированная сталь

4963 ● BL/G 3471 ● BR/WH

1×E27, max 100W

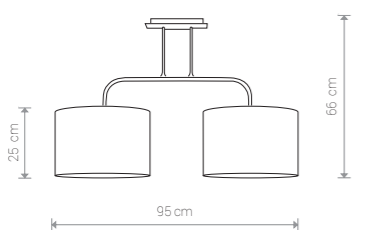

ALICE

abażur, stal lakierowana / shade, painted steel /
абажур, лакированная сталь

4962 ● BL/G

2×E27, max 100W

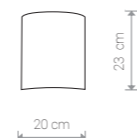

ALICE

abażur, stal lakierowana / shade, painted steel /
абажур, лакированная сталь

5724 ● BL/G 5660 ● BR/WH

1×E27, max 60W

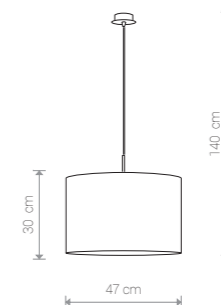

ALICE

abażur, stal lakierowana / shade, painted steel /
абажур, лакированная сталь

4961 ● BL/G 3473 ● BR/WH

1×E27, max 100W



ALICE 6818 GY

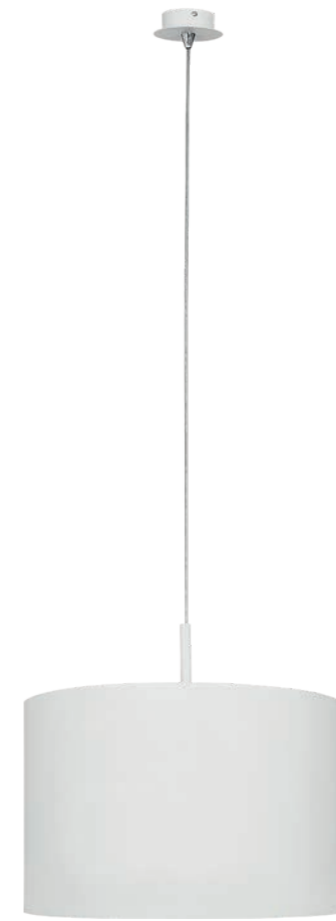

ALICE 5383 WH



ALICE 6817 GY

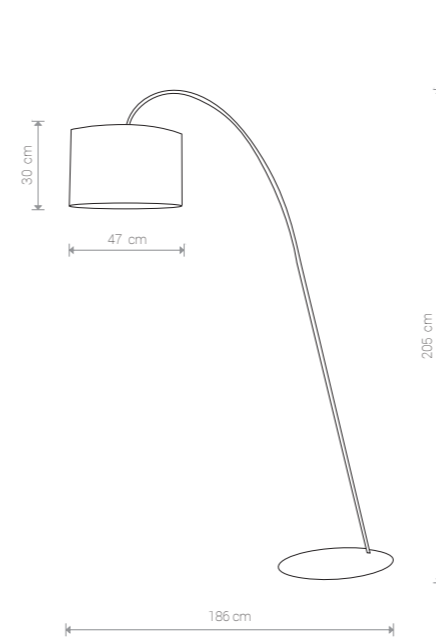

ALICE

abażur, stal lakierowana / shade, painted steel /
 абажур, лакированная сталь

6818 ● GY 5386 ○ WH

1×E27, max 100W

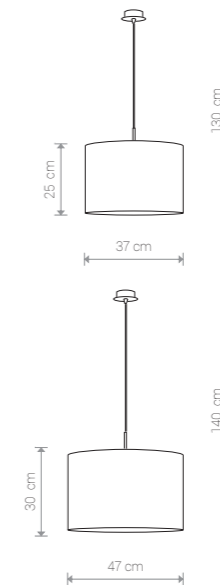

ALICE

abażur, stal lakierowana / shade, painted steel /
 абажур, лакированная сталь

6815 ● GY 5383 ○ WH

1×E27, max 100W

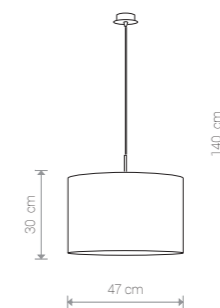

ALICE

abażur, stal lakierowana / shade, painted steel /
 абажур, лакированная сталь

6816 ● GY 5384 ○ WH

1×E27, max 100W

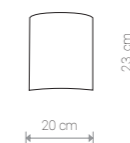

ALICE

abażur, stal lakierowana / shade, painted steel /
 абажур, лакированная сталь

6812 ● GY 5723 ○ WH

1×E27, max 60W

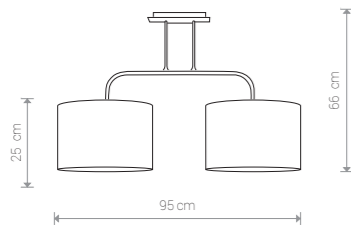

ALICE

abażur, stal lakierowana / shade, painted steel /
 абажур, лакированная сталь

6817 ● GY

2×E27, max 100W

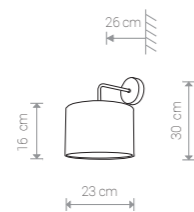

ALICE

abażur, stal lakierowana / shade, painted steel /
 абажур, лакированная сталь

9083 ● GY 9078 ○ WH

1×E27, max 60W

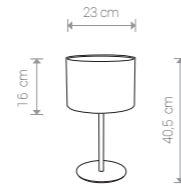

ALICE

abażur, stal lakierowana / shade, painted steel /
 абажур, лакированная сталь

9090 ● GY 9085 ○ WH

1×E27, max 60W

ALICE 3465 CE/WH

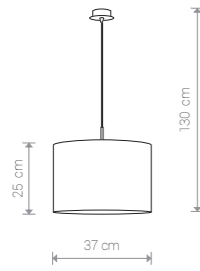

ALICE

abażur, stal lakierowana / shade, painted steel /
абажур, лакированная сталь

3465 ● CE/WH 3458 ○ EC/WH

1×E27, max 100W

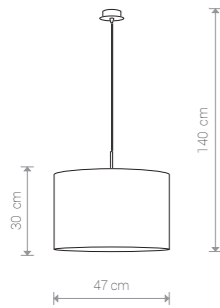

ALICE

abażur, stal lakierowana / shade, painted steel /
абажур, лакированная сталь

3466 ● CE/WH 3460 ○ EC/WH

1×E27, max 100W

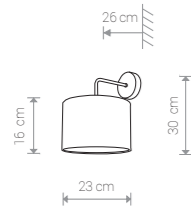

ALICE

abażur, stal lakierowana / shade, painted steel /
абажур, лакированная сталь

9081 ● CE/WH 9080 ○ EC/WH

1×E27, max 60W

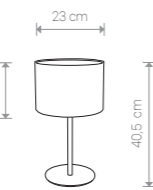

ALICE

abażur, stal lakierowana / shade, painted steel /
абажур, лакированная сталь

9088 ● CE/WH 9086 ○ EC/WH

1×E27, max 60W



ALICE 3466 CE/WH



ALICE 5663 EC/WH



ALICE 3457 EC/WH

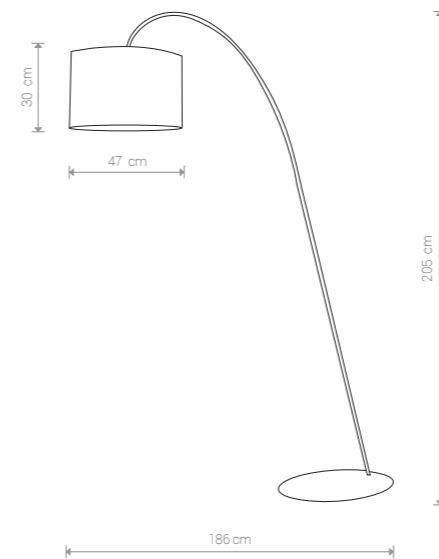

ALICE

abażur, stal lakierowana / shade, painted steel /
абажур, лакированная сталь

3464 ● CE/WH 3457 ○ EC/WH

1×E27, max 100W

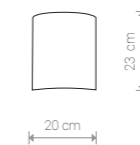

ALICE

abażur, stal lakierowana / shade, painted steel /
абажур, лакированная сталь

5662 ● CE/WH 5663 ○ EC/WH

1×E27, max 60W





ALANYA 9367 WH



ALANYA

abażur, stal lakierowana / shade, painted steel / абажур, лакированная сталь

9367 ○ WH 9371 ● GY

1×E27, max 60W



ALANYA 9373 GY

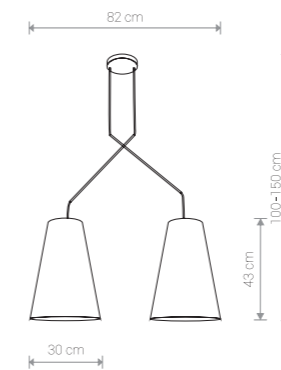

ALANYA

abażur, stal lakierowana / shade, painted steel / абажур, лакированная сталь

9370 ○ WH 9373 ● GY

2×E27, max 60W



RETTO A 5197



RETTO B 5380



RETTO C 6820

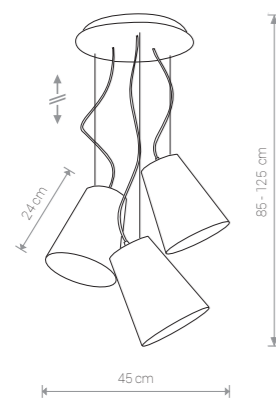

RETTO A

abażur, stal lakierowana / shade, painted steel /
 абажур, лакированная сталь

5197

3x E27, max 60W

RETTO B

abażur, stal lakierowana / shade, painted steel /
 абажур, лакированная сталь

5380

3x E27, max 60W

RETTO C

abażur, stal lakierowana / shade, painted steel /
 абажур, лакированная сталь

6820

3x E27, max 60W

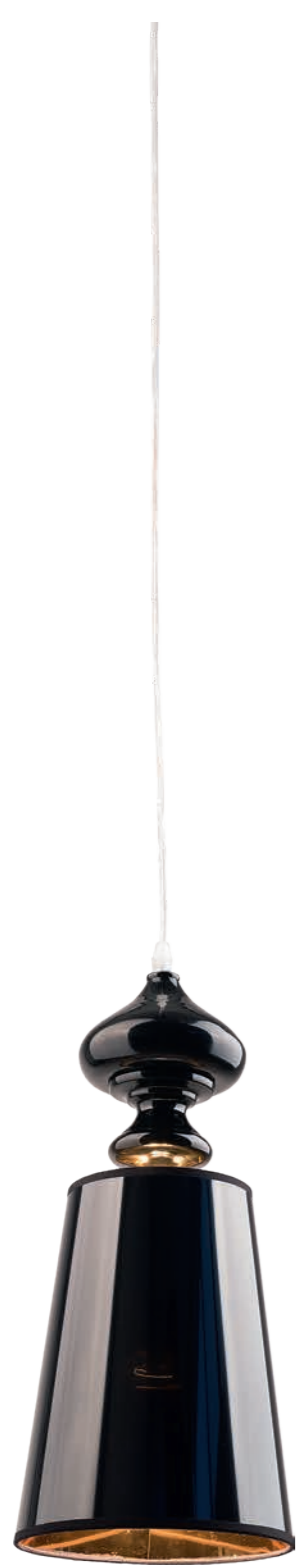

ALASKA 5756 BL



ALASKA 5754 BL



ALASKA

stal lakierowana, abażur / painted steel, shade /
лакированная сталь, абажур

5754 ● BL

Ⓢ 1×E27, max 60W

stal chromowana, abażur / electroplated steel, shade /
хромированная сталь, абажур

4465 ● CH

Ⓢ 1×E27, max 60W

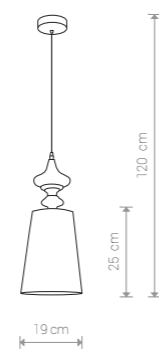

ALASKA

stal lakierowana, abażur / painted steel, shade /
лакированная сталь, абажур

5756 ● BL

Ⓢ 1×E27, max 60W

stal chromowana, abażur / electroplated steel, shade /
хромированная сталь, абажур

3730 ● CH

Ⓢ 1×E27, max 60W



ALASKA

stal lakierowana, abażur / painted steel, shade /
лакированная сталь, абажур

5753 ● BL

Ⓢ 1×E27, max 60W

stal chromowana, abażur / electroplated steel, shade /
хромированная сталь, абажур

3728 ● CH

Ⓢ 1×E27, max 60W



ALASKA

stal lakierowana, abażur / painted steel, shade /
лакированная сталь, абажур

5755 ● BL

Ⓢ 1×E27, max 60W

stal chromowana, abażur / electroplated steel, shade /
хромированная сталь, абажур

4466 ● CH

Ⓢ 1×E27, max 60W

ALASKA 4466 CH



ALASKA 3728 CH





FLAM 9731 GY

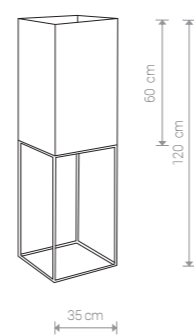

FLAM

abazur, stal lakierowana / shade, painted steel /
 абажур, лакированная сталь

9731 ● GY

Ⓛ 4×E27, max 60W



MOSS 9736 BL

MOSS 9737 BL



MOSS

abazur, stal lakierowana, HDF / shade, painted steel, HDF /
 абажур, лакированная сталь, HDF

9736 ● BL

Ⓛ 3×E27, max 60W

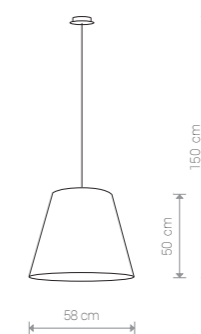

MOSS

abazur, stal lakierowana, HDF / shade, painted steel, HDF /
 абажур, лакированная сталь, HDF

9737 ● BL

Ⓛ 3×E27, max 60W



HOTEL 9298 GY

HOTEL 9300 GY

HOTEL 9303 GY

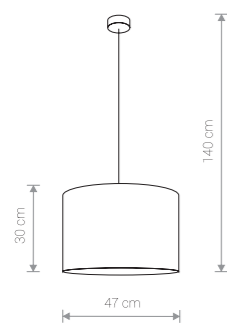

HOTEL

abazur, stal chromowana /
shade, electroplated steel /
абажур, хромированное сталь

9298 ● GY 8978 ● EC

Ⓛ 1×E27, max 60W

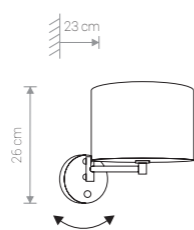

HOTEL

abazur, stal chromowana /
shade, electroplated steel /
абажур, хромированное сталь

9303 ● GY 8980 ● EC

Ⓛ 1×E14, max 60W



HOTEL 6800 EC

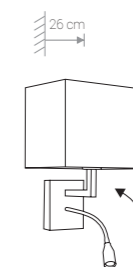

HOTEL LED

abazur, stal chromowana /
shade, electroplated steel /
абажур, хромированное сталь

6800 ● EC 9302 ● GY

Ⓛ 1×E27, max 60W, 1×LED 2,2W



HOTEL 4730 EC

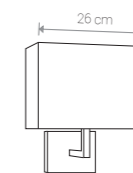

HOTEL

abazur, stal chromowana /
shade, electroplated steel /
абажур, хромированное сталь

4730 ● EC 9218 ● GY

Ⓛ 1×E27, max 60W



HOTEL 4731 EC

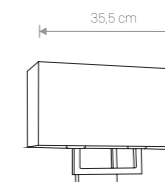

HOTEL

abazur, stal chromowana /
shade, electroplated steel /
абажур, хромированное сталь

4731 ● EC 9304 ● GY

Ⓛ 2×E27, max 60W

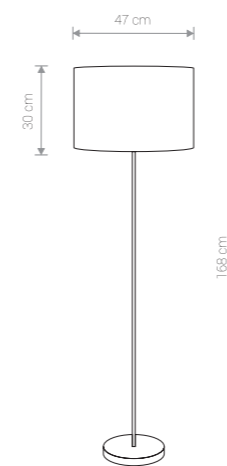

HOTEL

abazur, stal chromowana /
shade, electroplated steel /
абажур, хромированное сталь

9300 ● GY 8981 ● EC

Ⓛ 1×E27, max 60W

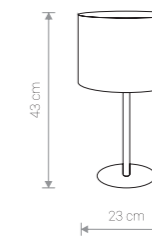

HOTEL

abazur, stal chromowana /
shade, electroplated steel /
абажур, хромированное сталь

9301 ● GY 8982 ● EC

Ⓛ 1×E27, max 60W

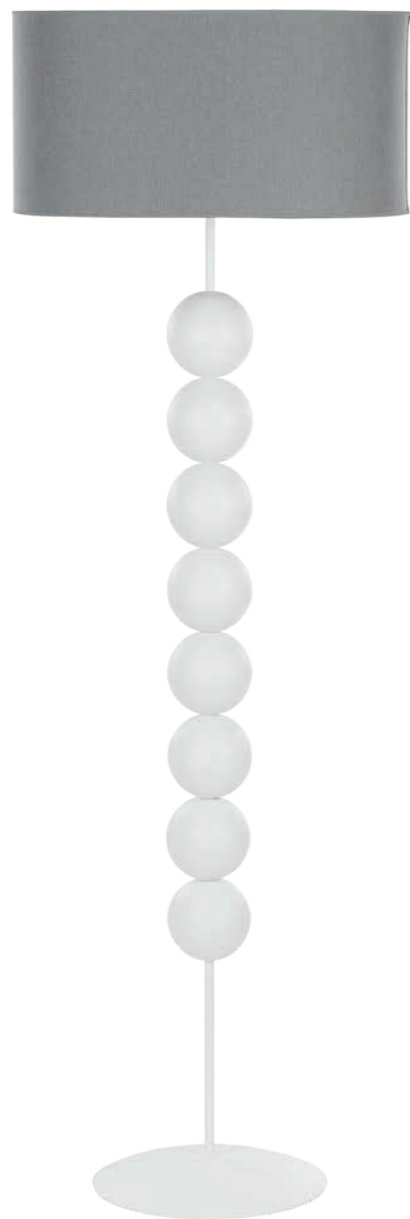

EDITH 6332 GY



EDITH 6331 GY

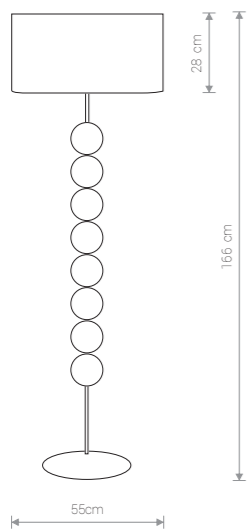

EDITH

abażur, stal lakierowana / shade, painted steel /
 абажур, лакированная сталь

6332 ● GY

Ⓛ 1×E27, max 60W

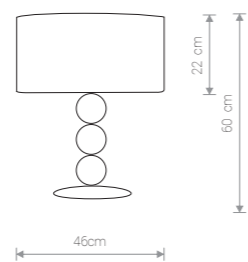

EDITH

abażur, stal lakierowana / shade, painted steel /
 абажур, лакированная сталь

6331 ● GY

Ⓛ 1×E27, max 60W



HOTEL PLUS 9073 WH



HOTEL PLUS 9071 GY

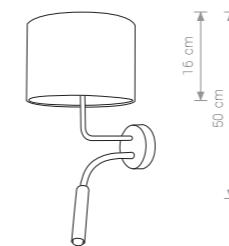

HOTEL PLUS

abażur, stal lakierowana, peszel /
 shade, painted steel, protective pipe, /
 абажур, лакированная сталь

9073 ○ WH 9071 ● GY

Ⓛ 1×E27, max 60W
 1×G9, max 20W



HOTEL PLUS 9072 GY



HOTEL PLUS

abażur, stal lakierowana, peszel /
 shade, painted steel, protective pipe, /
 абажур, лакированная сталь

9074 ○ WH 9072 ● GY

Ⓛ 1×E27, max 60W
 1×G9, max 20W



SWIVEL 6552 GY



SWIVEL 6560 BL/G

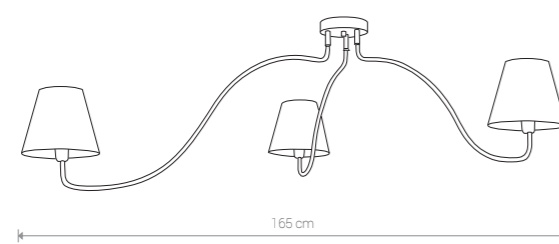

39 cm

165 cm

SWIVEL

abazur, stal lakierowana / shade, painted steel /
абажур, лакированная сталь

6545 ○ WH 6552 ● GY 6558 ● BL/G

Ⓛ 3×E14, max 40W

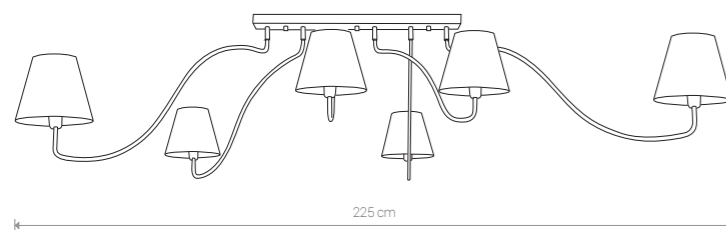

48 cm

225 cm

SWIVEL

abazur, stal lakierowana / shade, painted steel /
абажур, лакированная сталь

6546 ○ WH 6553 ● GY 6560 ● BL/G

Ⓛ 6×E14, max 40W



FISHING ROD 9075 BL/G

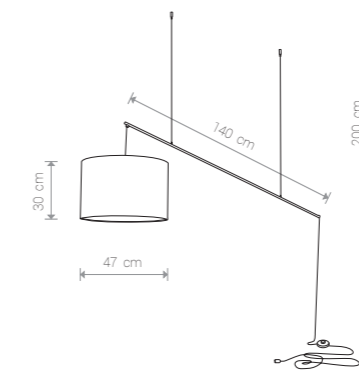

FISHING ROD

abazur, stal lakierowana / shade, painted steel /
абажур, лакированная сталь

9075 ● BL/G

Ⓛ 1×E27, max 60W



FLEX SHADE 9277 WH

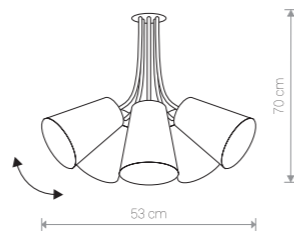

FLEX SHADE

abażur, peszel, stal lakierowana / shade, protective pipe, painted steel /
 абажур, кабель-канал, лакированная сталь

9277 ○ WH 9278 ● BL

5×E27, max 60W

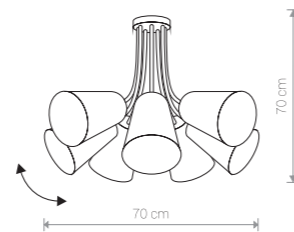

FLEX SHADE

abażur, peszel, stal lakierowana / shade, protective pipe, painted steel /
 абажур, кабель-канал, лакированная сталь

9275 ○ WH 9276 ● BL

7×E27, max 60W



FLEX SHADE 9764 WH

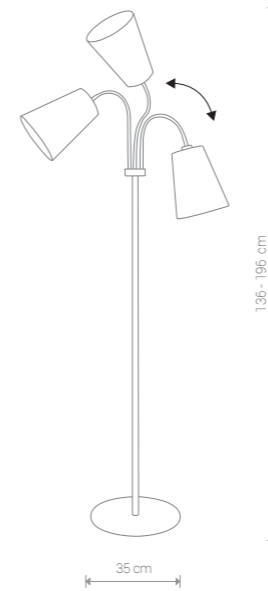

FLEX SHADE

abażur, peszel, stal lakierowana / shade, protective pipe, painted steel /
 абажур, кабель-канал, лакированная сталь

9760 ○ WH 9754 ● BL

3×E27, max 60W

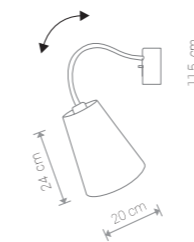

FLEX SHADE

abażur, peszel, stal lakierowana / shade, protective pipe, painted steel /
 абажур, кабель-канал, лакированная сталь

9764 ○ WH 9758 ● BL

1×E27, max 60W



FLEX SHADE 9754 BL



VIPER 6640 WH



HAWK 6540 GY



VIPER 6513 BL/G



HAWK 8843 WH

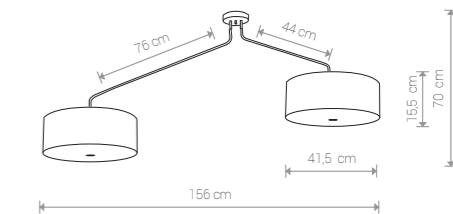
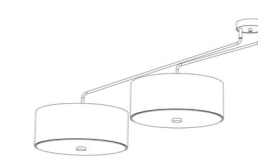
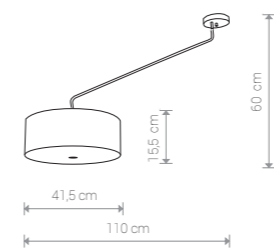
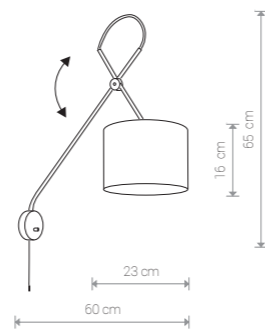
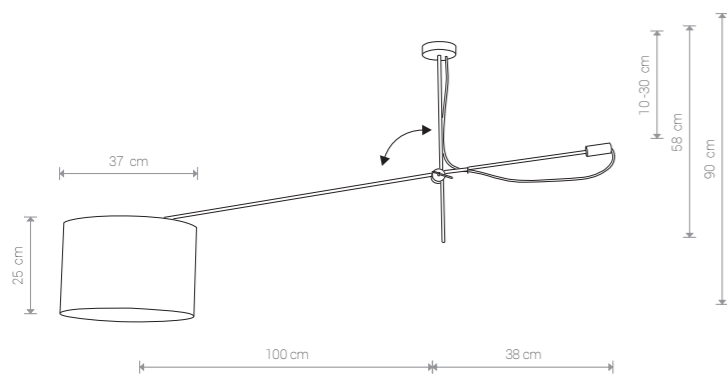

VIPER

stal lakierowana, abażur / painted steel, shade /
лакирована сталь, абажур

6640 ○ WH 6641 ● BL/G

Ⓛ 1×E27, max 60W

VIPER

stal lakierowana, abażur / painted steel, shade /
лакирована сталь, абажур

6512 ○ WH 6513 ● BL/G

Ⓛ 1×E14, max 40W

HAWK

stal lakierowana, abażur, szkło / painted steel, shade, glass /
лакирована сталь, абажур, стекло

6540 ● GY 8844 ○ WH

Ⓛ 3×E27, max 60W

HAWK

stal lakierowana, abażur, szkło / painted steel, shade, glass /
лакирована сталь, абажур, стекло

6541 ● GY 8843 ○ WH

Ⓛ 6×E27, max 60W

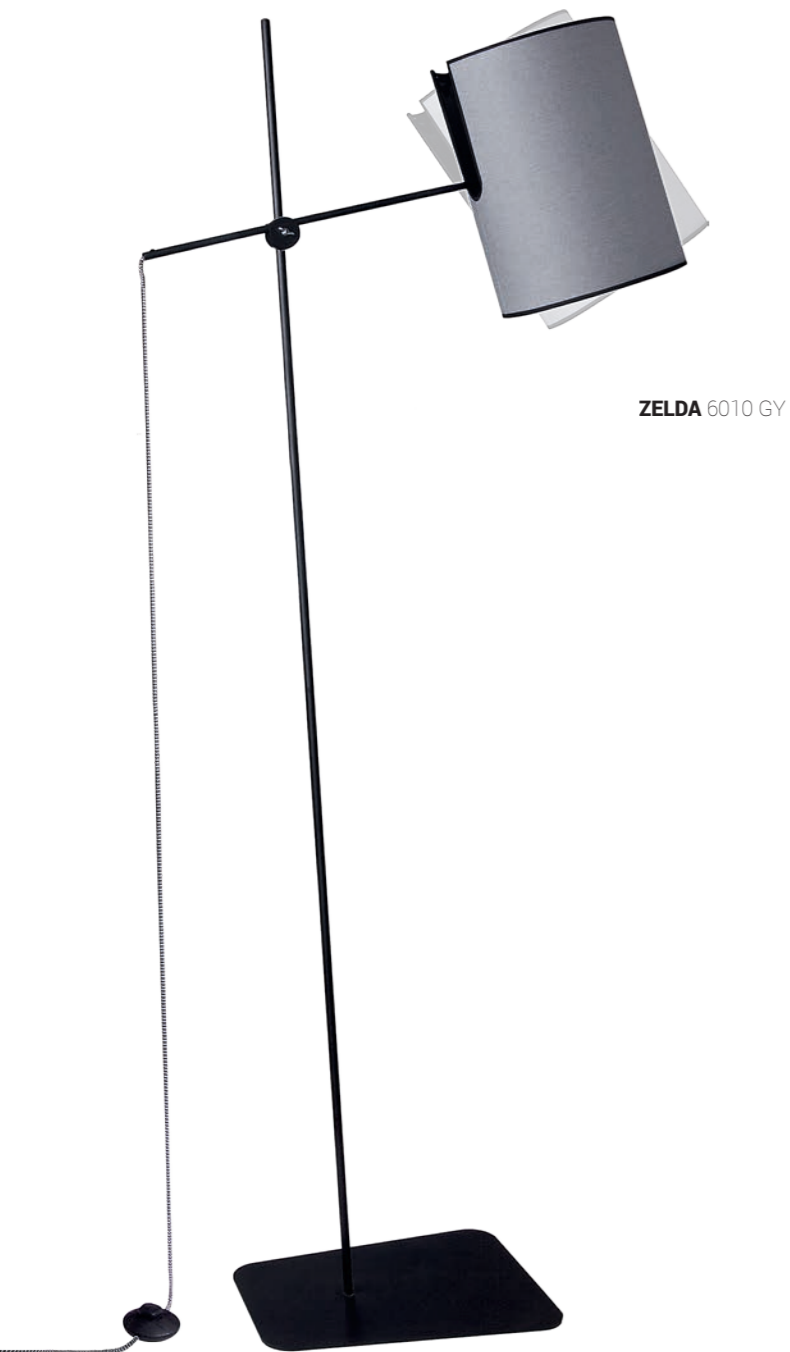

ZELDA 6010 GY

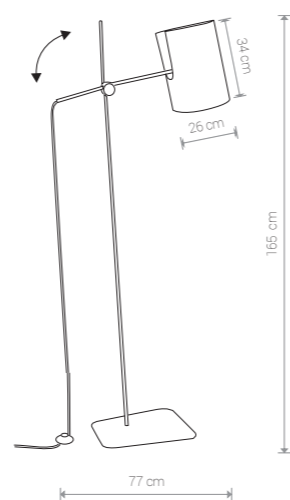

ZELDA

abazur, stal lakierowana / shade, painted steel /
 абажур, лакированная сталь

6010 ● GY

Ⓛ 1×E27, max 60W



ZELDA 6012 GY

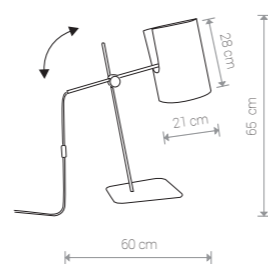

ZELDA

abazur, stal lakierowana / shade, painted steel /
 абажур, лакированная сталь

6012 ● GY

Ⓛ 1×E27, max 60W



ZELDA 6011 GY

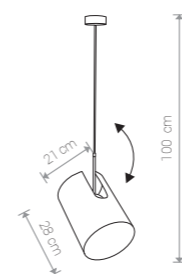

ZELDA

abazur, stal lakierowana / shade, painted steel /
 абажур, лакированная сталь

6551 ● GY

Ⓛ 1×E27, max 60W



ZELDA 6551 GY

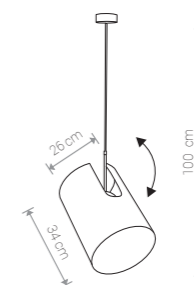

ZELDA

abazur, stal lakierowana / shade, painted steel /
 абажур, лакированная сталь

6011 ● GY

Ⓛ 1×E27, max 60W



WHEEL 9030 G

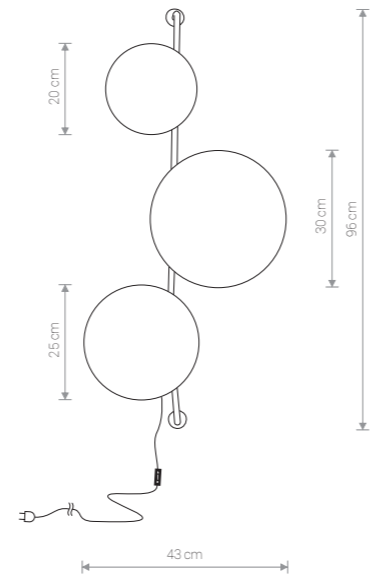

WHEEL

sklejka, stal lakierowana / plywood, painted steel /
дерево, лакирована сталь

9030 G 9034 BL

3×G9, max 20W

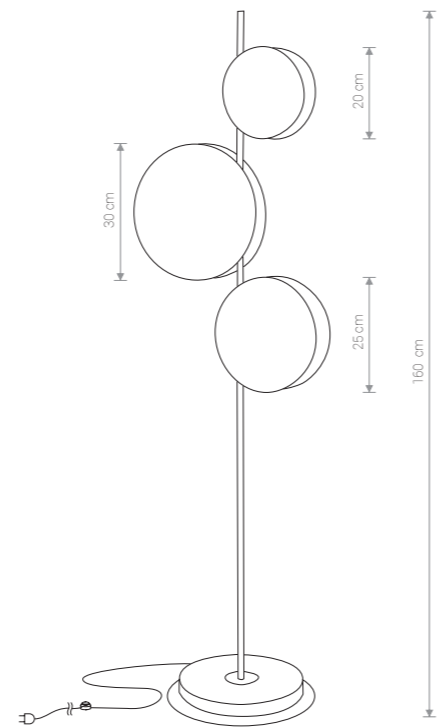

WHEEL

sklejka, stal lakierowana / plywood, painted steel /
дерево, лакирована сталь

9031 G 9035 BL

3×G9, max 20W

WHEEL 9031 G



WHEEL 9028 G



WHEEL 9033 BL

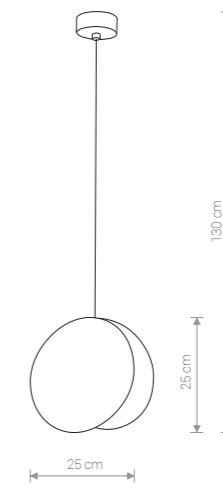

WHEEL

sklejka, stal lakierowana / plywood, painted steel /
дерево, лакирована сталь

9028 G 9033 BL

1×E27, max 40W

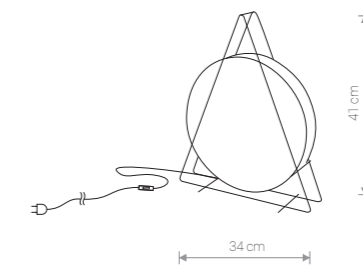

WHEEL

sklejka, stal lakierowana / plywood, painted steel /
дерево, лакирована сталь

9032 G 9036 BL

1×G9, max 20W

WHEEL 9032 G





MINIMAL 9375 OAK

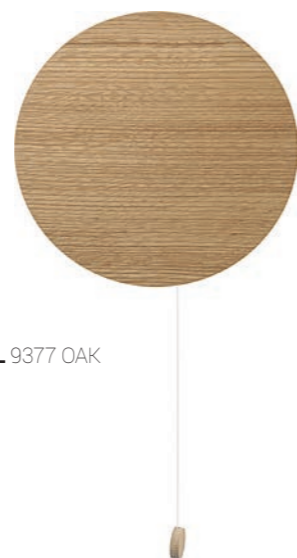
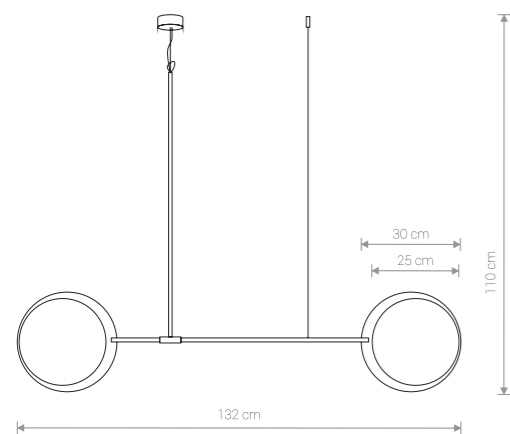

MINIMAL 9377 OAK

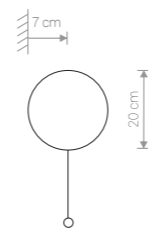

MINIMAL

drewno, stal lakierowana, mosiądz / wood, painted steel, brass /
дерево, лакированная сталь, латунь

9375 ● OAK

Ⓢ 2×E27, max 40W

MINIMAL

drewno / wood / дерево

9310 ● OAK SMOKED 9377 ● OAK

Ⓢ 1×G9, max 20W



WOOD DIAMOND 9372 NT

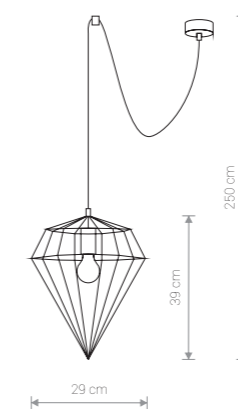

WOOD DIAMOND

sklejka / plywood / дерево

9372 ● NT

Ⓢ 1×E27, max 60W



WEZEN 9040 NT/BL

WEZEN 9038 NT/BL

WEZEN 9041 NT/BL

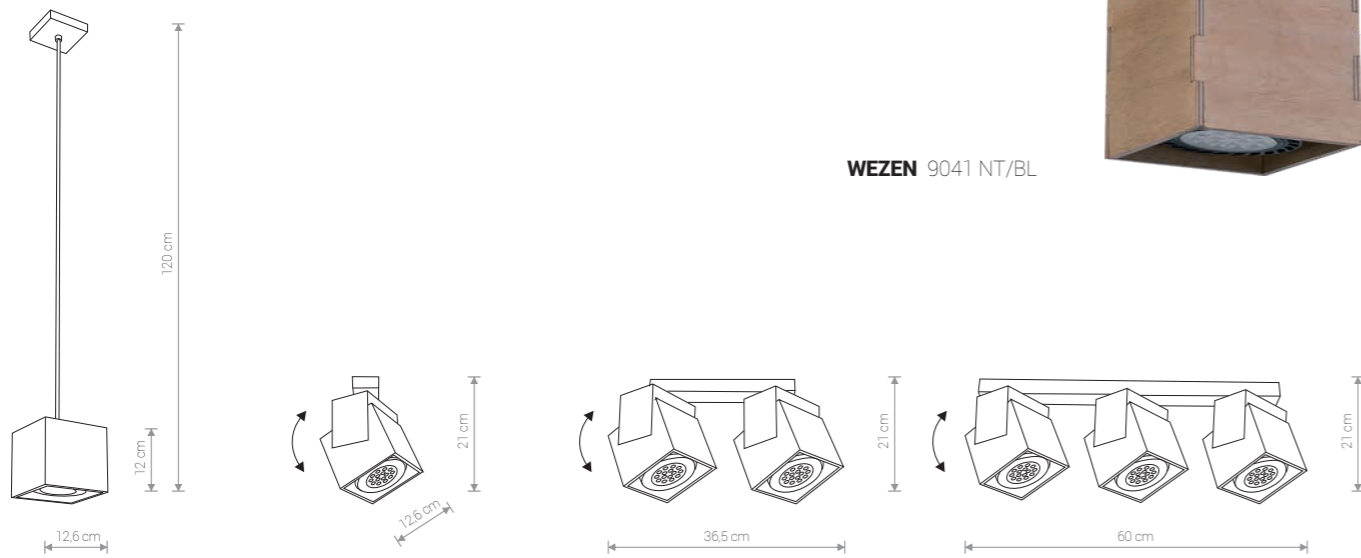

WEZEN

sklejka, stal lakierowana /
plywood, painted steel /
дерево, лакированная сталь

9041 ● NT/BL

Ⓛ 1×GU10, ES111, max 35W

WEZEN

sklejka, stal lakierowana /
plywood, painted steel /
дерево, лакированная сталь

9037 ● NT/BL

Ⓛ 1×GU10, ES111, max 35W

WEZEN

sklejka, stal lakierowana /
plywood, painted steel /
дерево, лакированная сталь

9038 ● NT/BL

Ⓛ 2×GU10, ES111, max 35W

WEZEN

sklejka, stal lakierowana /
plywood, painted steel /
дерево, лакированная сталь

9040 ● NT/BL

Ⓛ 3×GU10, ES111, max 35W



ROLLER 9134 BL



ROLLER 9133 BL

ROLLER

sklejka, stal lakierowana /
plywood, painted steel /
дерево, лакированная сталь

8976 ● NT/WH 9134 ● BL

Ⓛ 1×GU10, ES111, max 35W



ROLLER 8977 NT/WH



ROLLER 8977 NT/WH

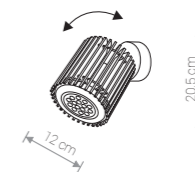

ROLLER

sklejka, stal lakierowana /
plywood, painted steel /
дерево, лакированная сталь

8977 ● NT/WH 9133 ● BL

Ⓛ 1×GU10, ES111, max 35W

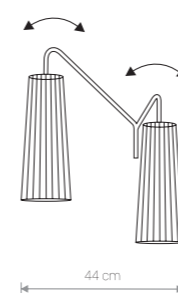

DOVER

sklejka, stal lakierowana /
plywood, painted steel /
дерево, лакированная сталь

9260 NT/WH 9265 BL

2xGU10, max 35W



DOVER

sklejka, stal lakierowana /
plywood, painted steel /
дерево, лакированная сталь

9261 NT/WH 9266 BL

1xGU10, max 35W

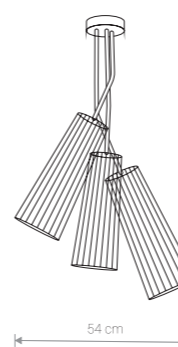

DOVER

sklejka, stal lakierowana /
plywood, painted steel /
дерево, лакированная сталь

9256 NT/WH 9262 BL

3xGU10, max 35W

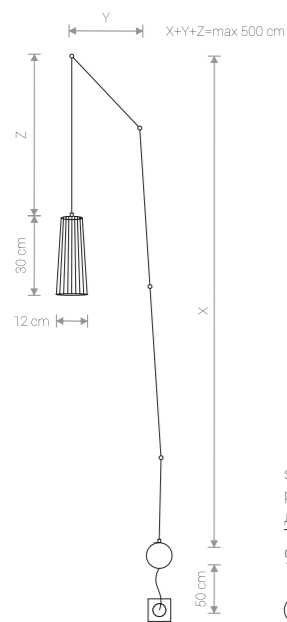

DOVER

sklejka, stal lakierowana /
plywood, painted steel /
дерево, лакированная сталь

9258 NT/BL 9264 BL

1xGU10, max 35W

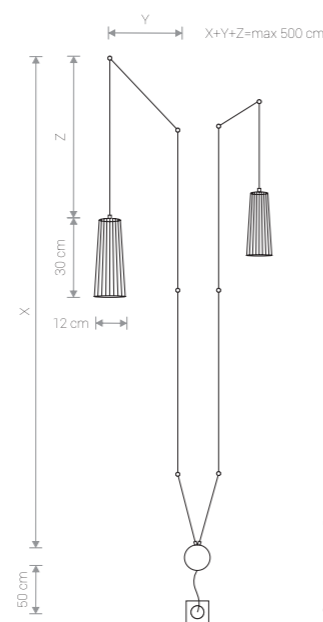

DOVER

sklejka, stal lakierowana /
plywood, painted steel /
дерево, лакированная сталь

9257 NT/BL 9263 BL

2xGU10, max 35W



BIO 6340 WH



BIO 6333 NT



BIOWAY 6883 BL



BIOWAY 6880 NT

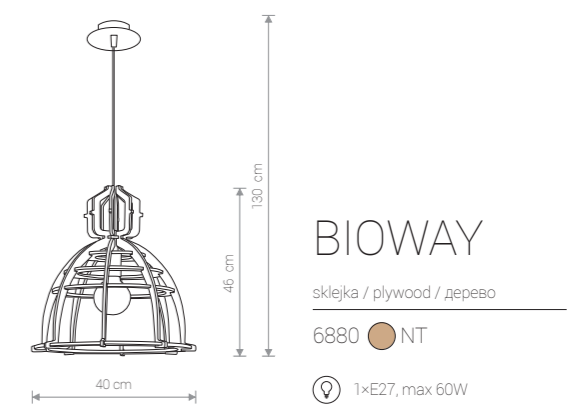
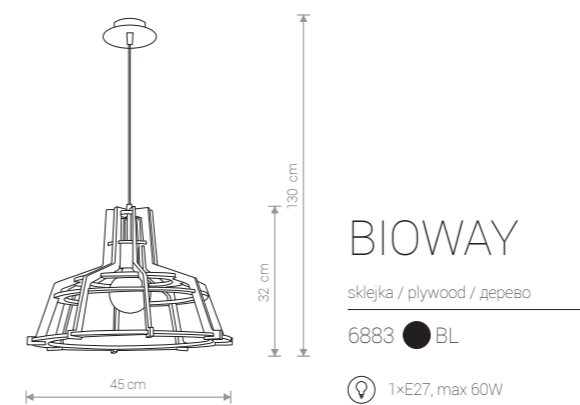
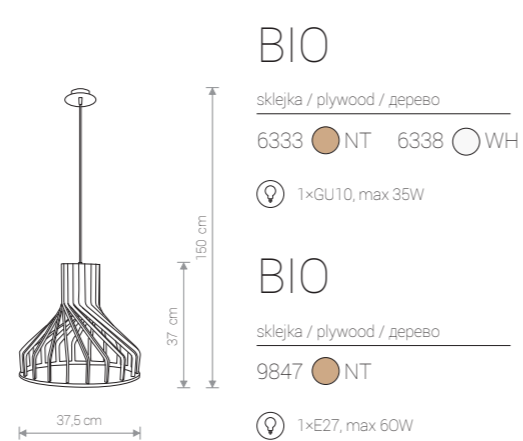
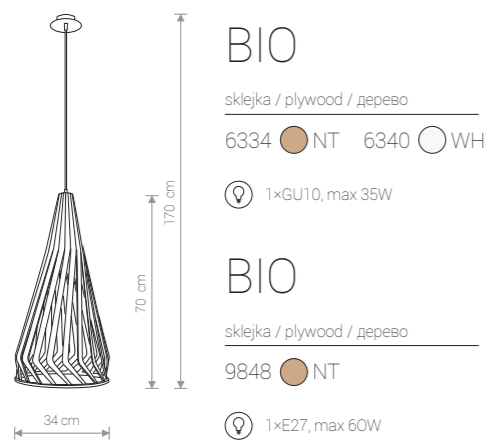



IKA C 4173 NT



IKA 4168 NT



IKA A 4171 NT



IKA D 4174 NT



IKA C

sklejka / plywood / дерево

4173 ● NT

Ⓢ 1×E27, max 60W

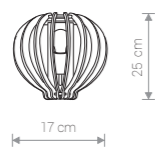

IKA

sklejka / plywood / дерево

4168 ● NT

Ⓢ 1×E27, max 60W

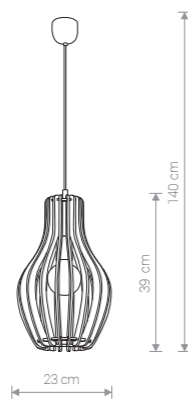

IKA A

sklejka / plywood / дерево

4171 ● NT

Ⓢ 1×E27, max 60W

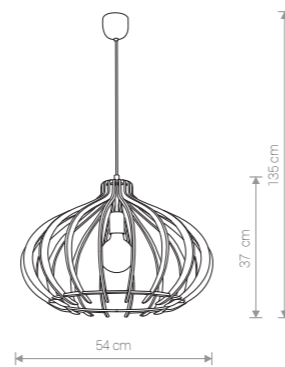

IKA D

sklejka / plywood / дерево

4174 ● NT

Ⓢ 1×E27, max 60W

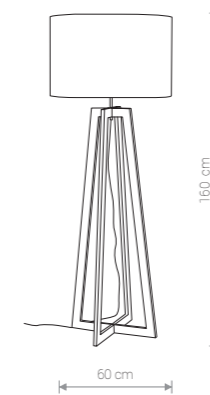

ACROSS

sklejka, abażur / plywood, shade / дерево, абажур

6927 ● NT

Ⓢ 1×E27, max 60W



ACROSS 6927 NT



TOSCA M 9048 GY

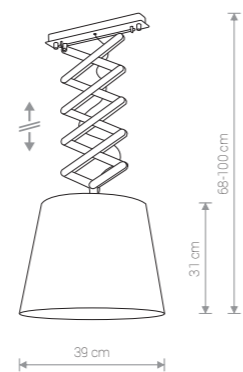

TOSCA M

sklejka, abażur, stal lakierowana / plywood, shade, painted steel /
дерево, абажур, лакирована сталь

9048 ● GY

1×E27, max 60W

TOSCA S 9050 GY

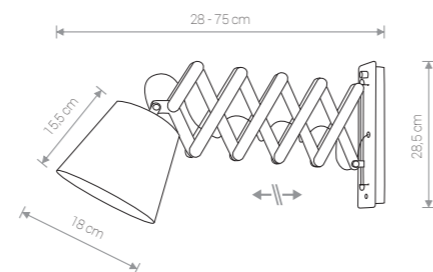

TOSCA S

sklejka, abażur, stal lakierowana / plywood, shade, painted steel /
дерево, абажур, лакирована сталь

9050 ● GY

1×E27, max 40W

NEO M 9365 GY



NEO S 9366 GY

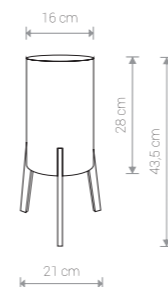

NEO S

sklejka, abażur / plywood, shade / дерево, абажур

9366 ● GY

1×E27, max 40W

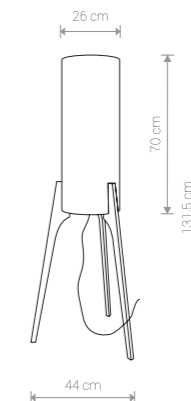

NEO M

sklejka, abażur / plywood, shade / дерево, абажур

9365 ● GY

3×E27, max 60W



AWINION 9281 WH

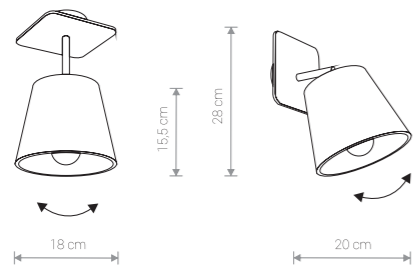

AWINION

sklejka, abażur / plywood, shade / дерево, абажур

9282 ○ WH 9718 ● GY

Ⓛ 1xE27, max 40W

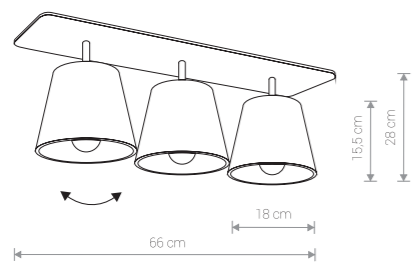

AWINION

sklejka, abażur / plywood, shade / дерево, абажур

9281 ○ WH 9717 ● GY

Ⓛ 3xE27, max 40W

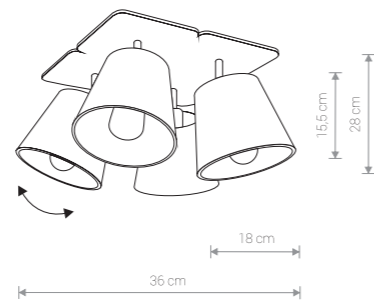

AWINION

sklejka, abażur / plywood, shade / дерево, абажур

9280 ○ WH 9716 ● GY

Ⓛ 4xE27, max 40W



AWINION 9716 GY

AWINION 9718 GY

COBA 9723



COBA 9724



COBA 9044 AN BR



COBA 9043 AN BR

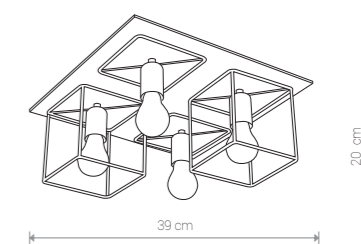
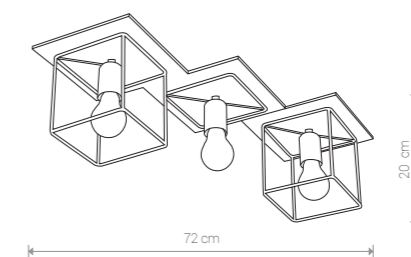
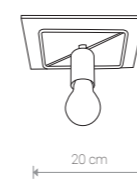
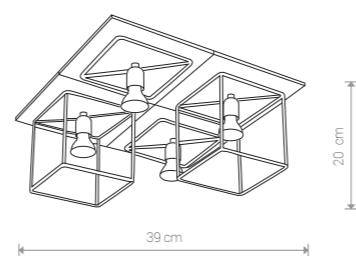
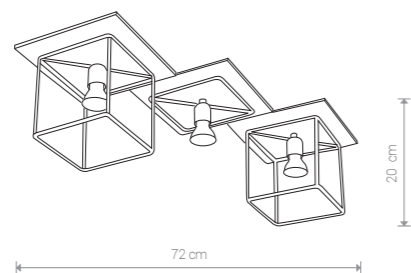
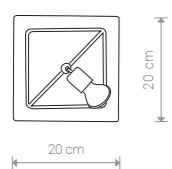

COBA

sklejka, stal lakierowana / plywod, painted steel /
дерево, лакированная сталь

9725 ● BL

1xGU10, max 35W

COBA

sklejka, stal lakierowana / plywod, painted steel /
дерево, лакированная сталь

9724 ●

3xGU10, max 35W

COBA

sklejka, stal lakierowana / plywod, painted steel /
дерево, лакированная сталь

9723 ●

4xGU10, max 35W

COBA

sklejka, stal lakierowana / plywod, painted
steel / дерево, лакированная сталь

9042 ● AN BR

1xE27, max 60W

COBA

sklejka, stal lakierowana / plywod, painted steel /
дерево, лакированная сталь

9043 ● AN BR

3xE27, max 60W

COBA

sklejka, stal lakierowana / plywod, painted steel /
дерево, лакированная сталь

9044 ● AN BR

4xE27, max 60W



OSLO LED 9315 SMOKED OAK

OSLO 9700 OAK

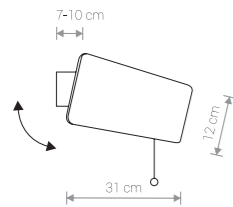

OSLO

drewno, stal / wood, steel / дерево, сталь, латунь

9311 ● SMOKED OAK

9700 ● OAK

⚡ 1x E14, max 40W

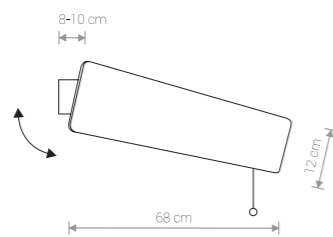

OSLO

drewno, stal / wood, steel / дерево, сталь, латунь

9312 ● SMOKED OAK

9701 ● OAK

⚡ 1x T8 LED, 11W, included

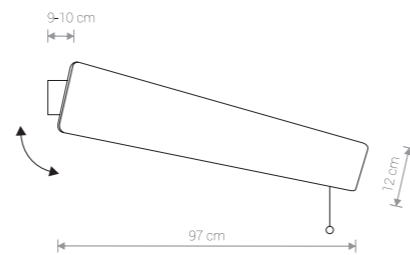

OSLO

drewno, stal / wood, steel / дерево, сталь, латунь

9313 ● SMOKED OAK

9634 ● OAK

⚡ 1x T8 LED, 16W, included

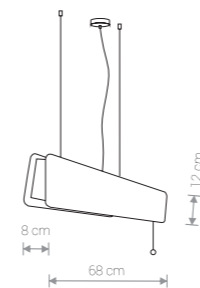

OSLO LED

drewno, stal / wood, steel / дерево, сталь, латунь

9314 ● SMOKED OAK

9635 ● OAK

⚡ 1x T8 LED, 11W, included

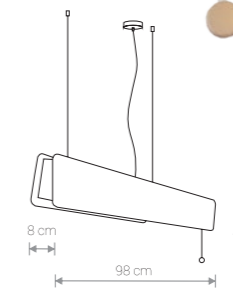

OSLO LED

drewno, stal / wood, steel / дерево, сталь, латунь

9315 ● SMOKED OAK

9698 ● OAK

⚡ 1x T8 LED, 16W, included

NAME	SIZE	POWER	COLOUR TEMP.	LUMINOUS FLUX	BEAM ANGLE	COLOUR RENDERING INDEX (CRI >=)	INPUT	POWER FACTOR	LED DRIVER	LIFETIME	MATERIAL
LED TUBE T8	60 cm	11W	3000K	950-1000 lm	200°	80	~230V, 50Hz	> 0,9	INCL.	25 000 h	CLEAR GLASS
LED TUBE T8	90 cm	16W	3000K	1400-1500 lm	200°	80	~230V, 50Hz	> 0,9	INCL.	25 000 h	CLEAR GLASS



TORINO 6878 WH

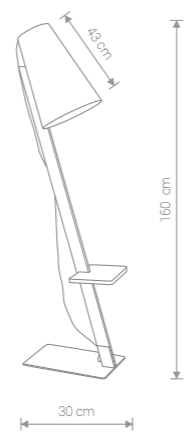

TORINO

stal lakierowana, drewno / painted steel, wood /
лакирована сталь, дерево

6878 ○ WH

1×E27, max 60W

WOOD BOY 6535 WH

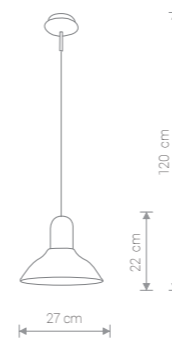

WOOD BOY

stal lakierowana, drewno / painted steel, wood /
лакирована сталь, дерево

6535 ○ WH

1×E27, max 60W

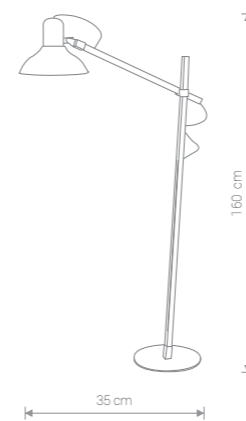

WOOD BOY

stal lakierowana, drewno / painted steel, wood /
лакирована сталь, дерево

6534 ○ WH

1×E27, max 60W



WOOD BOY 6534 WH



MONACO 9362 BL



MONACO 9363 BL

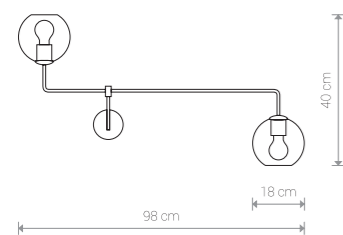

MONACO

szkło, stal lakierowana / glass, painted steel /
стекло, лакированная сталь

9362 ● BL

Ⓛ 2×E27, max 60W

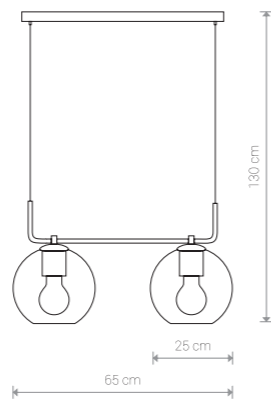

MONACO

szkło, stal lakierowana / glass, painted steel /
стекло, лакированная сталь

9363 ● BL

Ⓛ 2×E27, max 60W

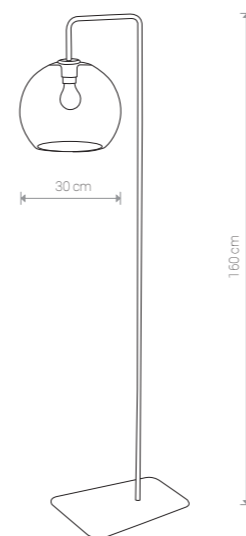

MONACO

szkło, stal lakierowana / glass, painted steel /
стекло, лакированная сталь

8794 ● BL

Ⓛ 1×E27, max 60W

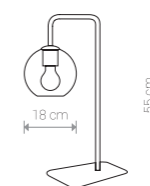

MONACO

szkło, stal lakierowana / glass, painted steel /
стекло, лакированная сталь

9308 ● BL

Ⓛ 1×E27, max 60W

MONACO 9308 BL

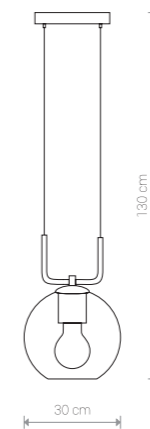

MONACO

szkło, stal lakierowana / glass, painted steel /
стекло, лакированная сталь

9364 ● BL

Ⓛ 1×E27, max 60W



MONACO 9364 BL



CRANE 9374 BL

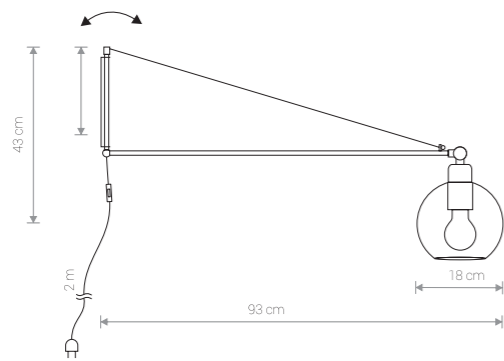

CRANE

stal, szkło / steel, glass / сталь, стекло

9374 ● BL

1×E27, max 60W



VETRO 9131 BL

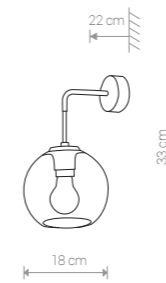

VETRO

szkło, stal lakierowana / glass, painted steel /
стекло, лакированная сталь

9132 ● BL

1×E27, max 60W

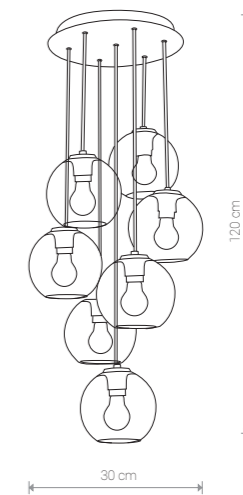

VETRO

szkło, stal lakierowana / glass, painted steel /
стекло, лакированная сталь

9131 ● BL

7×E27, max 60W



AMALFI 9153 G

AMALFI 9152 SI



AMALFI 9155 G

AMALFI 9154 SI



AMALFI 9153 G

AMALFI 9152 SI

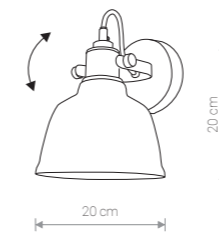

AMALFI

szkło metalizowane, stal lakierowana, mosiądz /
metallized glass, painted steel, brass /
металлизированное стекло, лакированная сталь, латунь

9154 ● SI 9155 ● G

Ⓢ 1×E27, max 60W

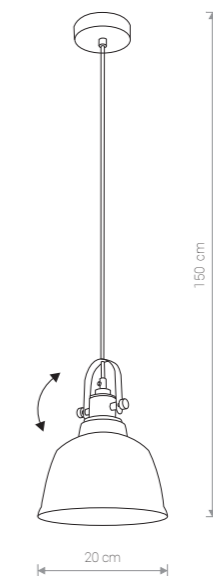

AMALFI

szkło metalizowane, stal lakierowana, mosiądz /
metallized glass, painted steel, brass /
металлизированное стекло, лакированная сталь, латунь

9152 ● SI 9153 ● G

Ⓢ 1×E27, max 60W



POLARIS 9060 TR/CH

POLARIS 9057 G



POLARIS 9058 CO



POLARIS 9056 CH

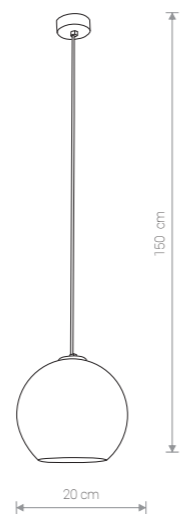

POLARIS

szkło metalizowane, stal lakierowana / metallized glass, painted steel /
металлизированное стекло, лакированная сталь

9060 ● TR/CH

1×E27, max 60W

POLARIS

szkło metalizowane, stal lakierowana / metallized glass, painted steel /
металлизированное стекло, лакированная сталь

9056 ● CH 9057 ● G 9058 ● CO

1×E27, max 60W



POLARIS 9056 CH



GLOBE 4953 CH

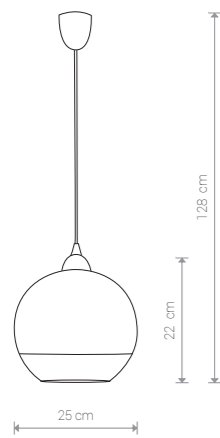

GLOBE

szkło matalizowane, tworzywo sztuczne /
metallized glass, plastic /
металлизованное стекло, пластик

4953 CH 5764 CO

1xE27, max 60W



GLOBE 4952 CH

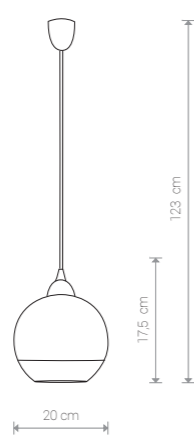

GLOBE

szkło matalizowane, tworzywo sztuczne /
metallized glass, plastic /
металлизованное стекло, пластик

4952 CH 5763 CO

1xE27, max 60W



GLOBE 5764 CO

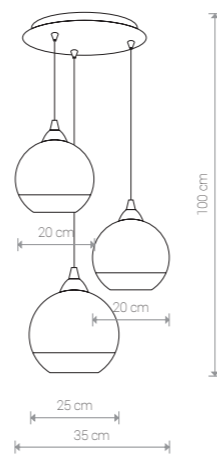

GLOBE

szkło matalizowane, tworzywo sztuczne /
metallized glass, plastic /
металлизованное стекло, пластик

9306 CH 9307 CO

3xE27, max 60W



GLOBE 9307 CO



SALVA A 5422 CH



SALVA E 5428 CH



SALVA C 5424 CH



SALVA G 6845 CH



SALVA H 6846 CH

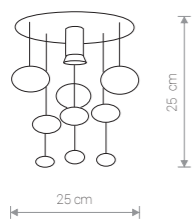

SALVA A

szkło, stal nierdzewna / glass, stainless steel / стекло, нержавеющая сталь

5422 ● CH

Ⓛ 1×GU10, max 35W

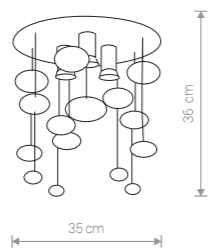

SALVA C

szkło, stal nierdzewna / glass, stainless steel / стекло, нержавеющая сталь

5424 ● CH

Ⓛ 3×GU10, max 35W

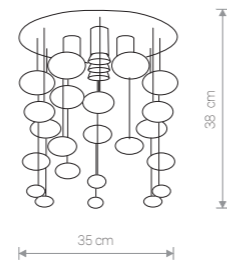

SALVA E

szkło, stal nierdzewna / glass, stainless steel / стекло, нержавеющая сталь

5428 ● CH

Ⓛ 5×GU10, max 35W

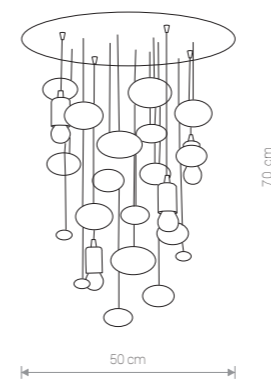

SALVA G

szkło, stal nierdzewna / glass, stainless steel / стекло, нержавеющая сталь

6845 ● CH

Ⓛ 4×E27, max 60W

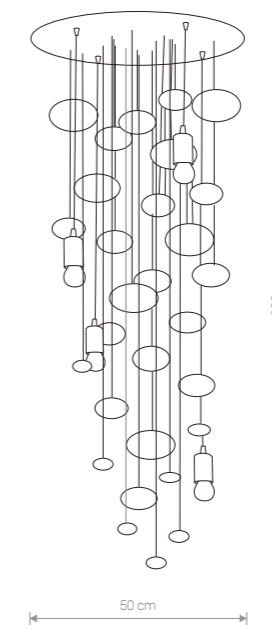

SALVA H

szkło, stal nierdzewna / glass, stainless steel / стекло, нержавеющая сталь

6846 ● CH

Ⓛ 4×E27, max 60W



NUAGE 7027 WH



NUAGE S

szkło, stal chromowana / glass, electroplated steel /
стекло, хромированная сталь

7024 ○ WH

1×E27, max 60W

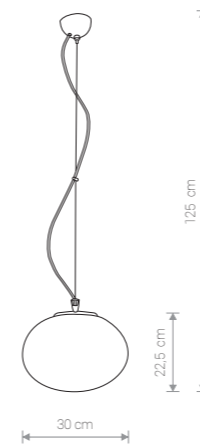

NUAGE M

szkło, stal chromowana / glass, electroplated steel /
стекло, хромированная сталь

7025 ○ WH

1×E27, max 60W

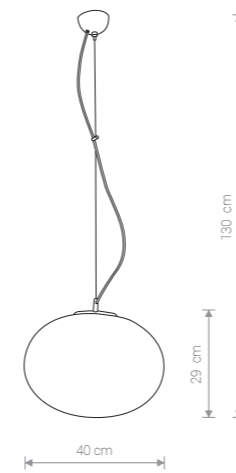

NUAGE L

szkło, stal chromowana / glass, electroplated steel /
стекло, хромированная сталь

7026 ○ WH

1×E27, max 100W

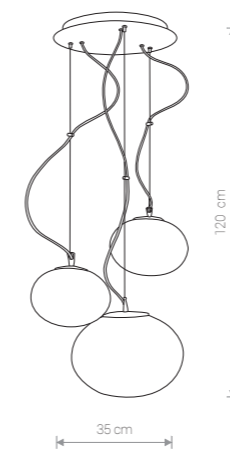

NUAGE

szkło, stal chromowana / glass, electroplated steel /
стекло, хромированная сталь

7027 ○ WH

3×E27, max 60W



NUAGE M 7025 WH

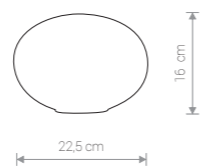

NUAGE S

szkło / glass / стекло

7021 ○ WH

1×E27, max 60W

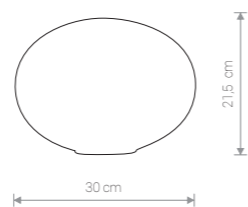

NUAGE M

szkło / glass / стекло

7022 ○ WH

1×E27, max 60W

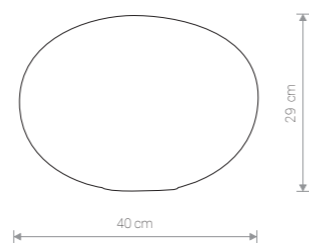

NUAGE L

szkło / glass / стекло

7023 ○ WH

1×E27, max 100W

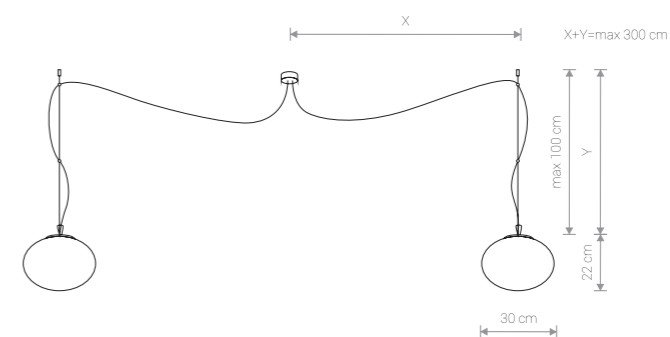

NUAGE

szkło, stal chromowana / glass, electroplated steel / стекло, хромированная сталь

9272 ○ WH

2×E27, max 60W

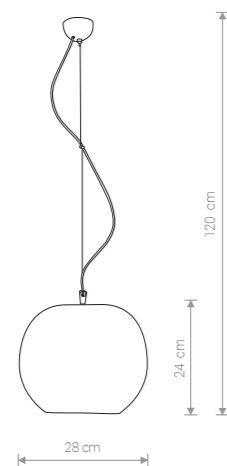

IBIZA SPHERE

szkło, stal chromowana / glass, electroplated steel /
стекло, хромированная сталь

3596 ○ TR

1×E27, max 60W



TESALLI 4654 CH

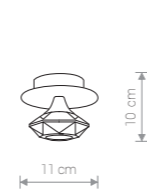

TESALLI

stal chromowana, kryształ / electroplated steel, crystal /
хромированная сталь, кристалл

4651 ● CH

1×G9, max 40W, **included**

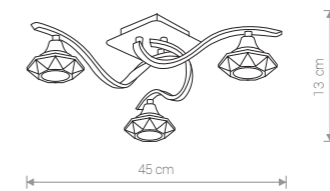

TESALLI

stal chromowana, kryształ / electroplated steel, crystal /
хромированная сталь, кристалл

4652 ● CH

3×G9, max 40W, **included**

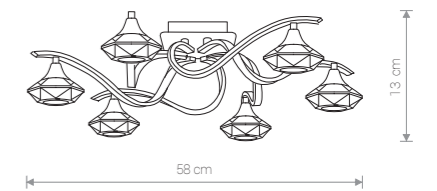

TESALLI

stal chromowana, kryształ / electroplated steel, crystal /
хромированная сталь, кристалл

4653 ● CH

6×G9, max 40W, **included**

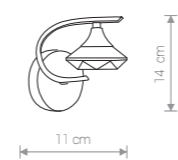

TESALLI

stal chromowana, kryształ / electroplated steel, crystal /
хромированная сталь, кристалл

4650 ● CH

1×G9, max 40W, **included**

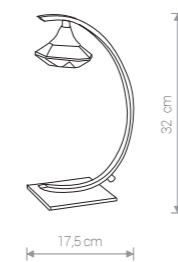

TESALLI

stal chromowana, kryształ / electroplated steel, crystal /
хромированная сталь, кристалл

4648 ● CH

1×G9, max 40W, **included**

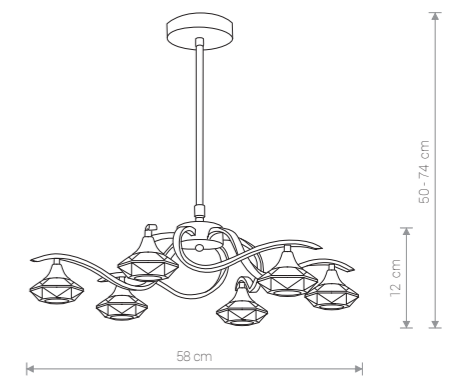

TESALLI

stal chromowana, kryształ / electroplated steel, crystal /
хромированная сталь, кристалл

4654 ● CH

6×G9, max 40W, **included**

MODENA 5261 BL



TOSCANA 4013 WH



CORSICA 4524 WH



FOGGIA 4025 CH

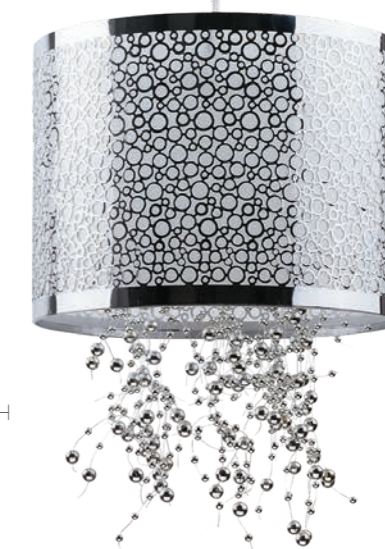

MODENA 5263 WH



MODENA 4014 BL

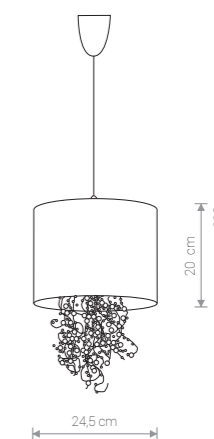
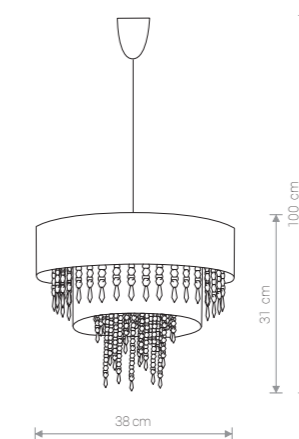
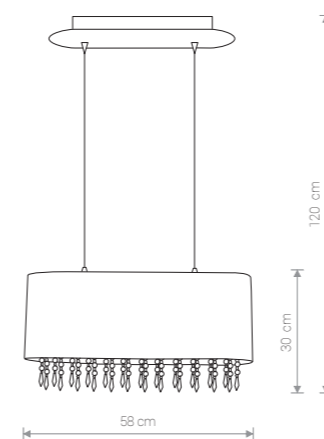
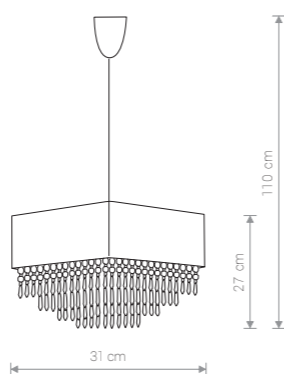
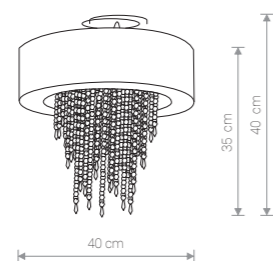
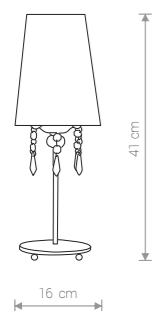

MODENA

abażur, kryształki akrylowe, stal chromowana / shade, acrylic crystals, electroplated steel / абажур, акриловые кристаллики, хромированная сталь

5263 ○ WH 5262 ● BL

1×E14, max 40W

MODENA

abażur, kryształki akrylowe / shade, acrylic crystals / абажур, акриловые кристаллики

5261 ● BL

1×E27, max 60W

MODENA

abażur, kryształki akrylowe / shade, acrylic crystals / абажур, акриловые кристаллики

4014 ● BL

1×E27, max 60W

CORSICA

abażur, kryształki / shade, crystals / абажур, кристаллики

4524 ○ WH

2×E27, max 60W

TOSCANA

abażur, kryształki akrylowe / shade, acrylic crystals / абажур, акриловые кристаллики

4013 ○ WH

1×E27, max 60W

FOGGIA

abażur, tworzywo sztuczne / shade, plastics / абажур, пластики

4025 ● CH

1×E27, max 60W

KATERINA 5210 TR



KATERINA 5211 BL



KATERINA 5221 WH



KATERINA 5208 WH



KATERINA 5212 BL

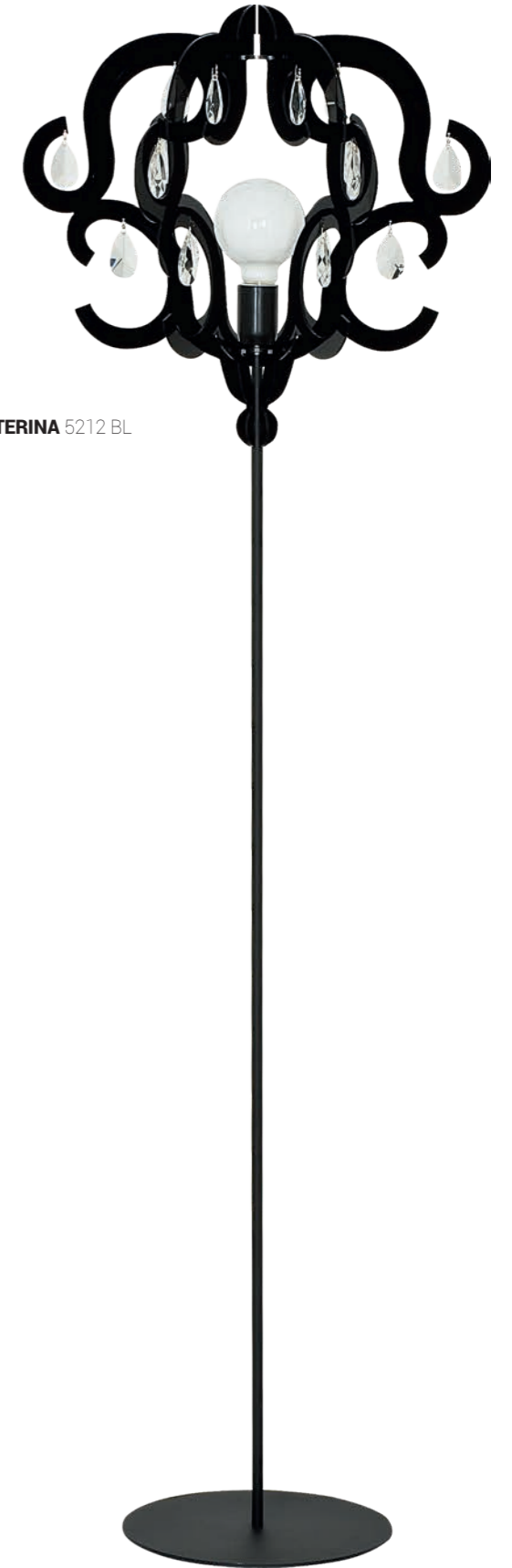

48 cm

38.5 cm

KATERINA

stal lakierowana, PC, kryształki / painted steel, PC, crystals / лакированная сталь, PC, кристаллики

5221 ○ WH 5218 ● BL

1×E27, max 60W



48 cm

170 cm

KATERINA

stal lakierowana, PC, kryształki / painted steel, PC, crystals / лакированная сталь, PC, кристаллики

5214 ○ WH 5212 ● BL

1×E27, max 60W



48 cm

100 cm

KATERINA

stal lakierowana, PC, kryształki / painted steel, PC, crystals / лакированная сталь, PC, кристаллики

5208 ○ WH 5210 ○ TR 5211 ● BL

1×E27, max 60W



UFO 050/01 BL



UFO 5322 SI

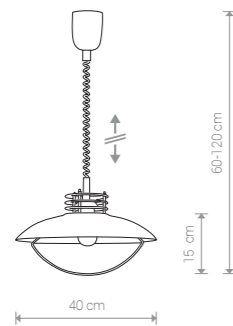

UFO

stal lakierowana / painted steel / лакированная сталь

050/01 ● BL 050/00 ○ WH 5322 ○ SI

1×E27, max 60W



SCORPIO 3007 G



SCORPIO 3008 WH

SCORPIO 3006 SI

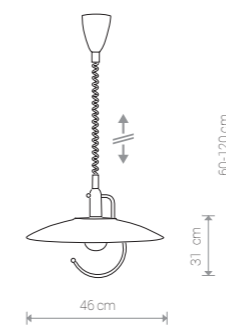

SCORPIO

szkło, stal lakierowana / glass, painted steel / стекло, лакированная сталь

3007 ● G 3006 ○ SI 3008 ○ WH

1×E27, max 100W

STRAIGHT LED L 9628 GR



STRAIGHT LED M 9621 WH



STRAIGHT LED S 9623 SI



STRAIGHT LED CEILING S

stal lakierowana / painted steel / лакированная сталь

9626 ● GR 9623 ○ SI 9620 ○ WH

📍 T8, 11W LED, included

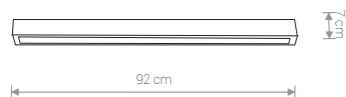

STRAIGHT LED CEILING M

stal lakierowana / painted steel / лакированная сталь

9627 ● GR 9624 ○ SI 9621 ○ WH

📍 T8, 16W LED, included

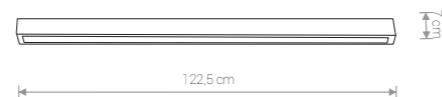

STRAIGHT LED CEILING L

stal lakierowana / painted steel / лакированная сталь

9628 ● GR 9625 ○ SI 9622 ○ WH

📍 T8, 22W LED, included

NAME	SIZE	POWER	COLOUR TEMP.	LUMINOUS FLUX	BEAM ANGLE	COLOUR RENDERING INDEX (CRI >)	INPUT	POWER FACTOR	LIFETIME	MATERIAL
LED TUBE T8	60 cm	11W	3000K	950-1000 lm	200°	80	~230V, 50Hz	> 0,9	25 000 h	CLEAR GLASS
LED TUBE T8	90 cm	16W	3000K	1400-1500 lm	200°	80	~230V, 50Hz	> 0,9	25 000 h	CLEAR GLASS
LED TUBE T8	120 cm	22W	3000K	2000-2100 lm	200°	80	~230V, 50Hz	> 0,9	25 000 h	CLEAR GLASS



STRAIGHT LED S 9620 WH

STRAIGHT LED WALL L 9612 WH



STRAIGHT LED WALL M 9617 GR



STRAIGHT LED WALL S 9613 SI

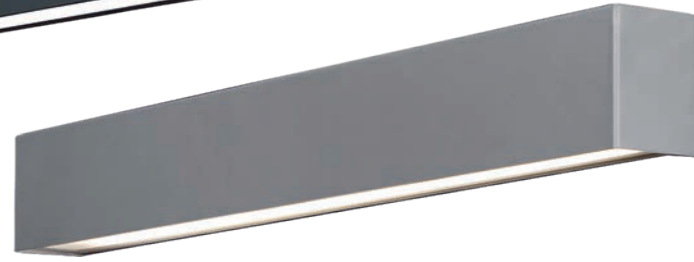

STRAIGHT WALL XS 6345 WH

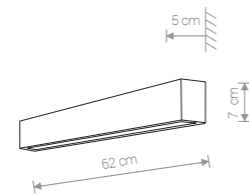
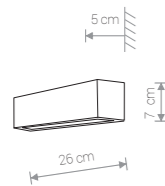
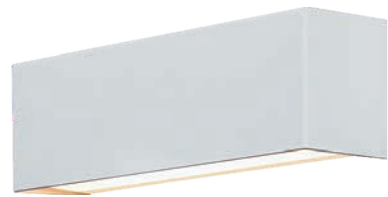

STRAIGHT WALL XS

stal lakierowana / painted steel / лакирована сталь

6345 ○ WH 6354 ○ SI 6350 ● GR

Ⓢ 1×E14, max 40W

STRAIGHT LED WALL S

stal lakierowana / painted steel / лакирована сталь

9610 ○ WH 9613 ○ SI 9618 ● GR

Ⓢ T8, 11W LED, included

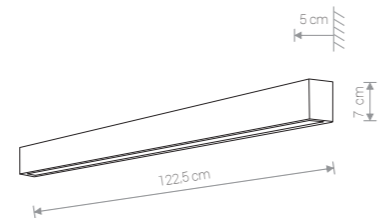
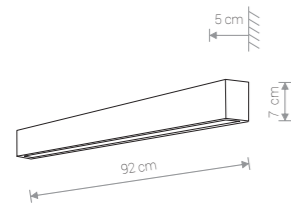

STRAIGHT LED WALL M

stal lakierowana / painted steel / лакирована сталь

9611 ○ WH 9614 ○ SI 9617 ● GR

Ⓢ T8, 16W LED, included

STRAIGHT LED WALL L

stal lakierowana / painted steel / лакирована сталь

9612 ○ WH 9615 ○ SI 9616 ● GR

Ⓢ T8, 22W LED, included

NAME	SIZE	POWER	COLOUR TEMP.	LUMINOUS FLUX	BEAM ANGLE	COLOUR RENDERING INDEX (CRI >)	INPUT	POWER FACTOR	LIFETIME	MATERIAL
LED TUBE T8	60 cm	11W	3000K	950-1000 lm	200°	80	~230V, 50Hz	> 0,9	25 000 h	CLEAR GLASS
LED TUBE T8	90 cm	16W	3000K	1400-1500 lm	200°	80	~230V, 50Hz	> 0,9	25 000 h	CLEAR GLASS
LED TUBE T8	120 cm	22W	3000K	2000-2100 lm	200°	80	~230V, 50Hz	> 0,9	25 000 h	CLEAR GLASS



H LED 8908 WH

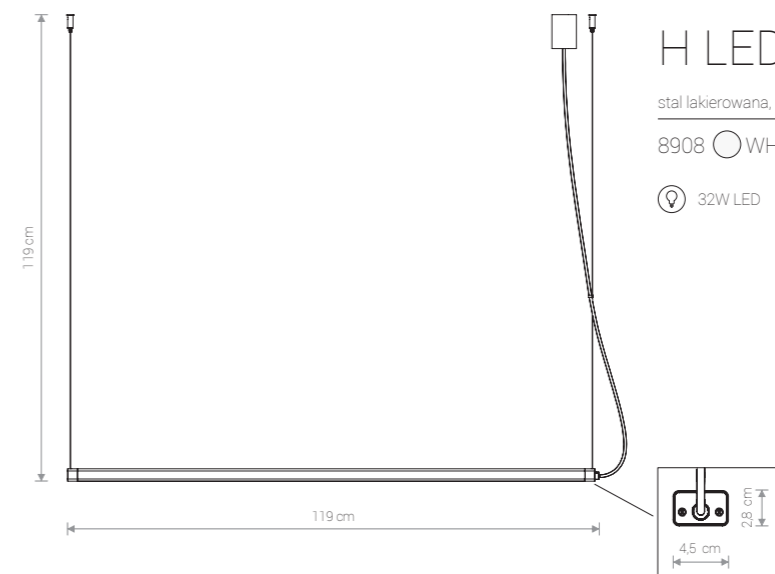

H LED

stal lakierowana, PC / painted steel, PC / лакированная сталь, PC

8908 ○ WH 8910 ● WH/BL

Ⓢ 32W LED

Item No.	INPUT POWER	COLOUR TEMP.	LUMINOUS FLUX	LUMINAIRE EFFICIENCY	COLOUR RENDERING INDEX (CRI >)	INPUT	LIFETIME
8908, 8910	36W LED	3000K	2700 lm	75	80	~230V, 50Hz	50 000 h



Q LED 8907 BL



A LED 8904 WH

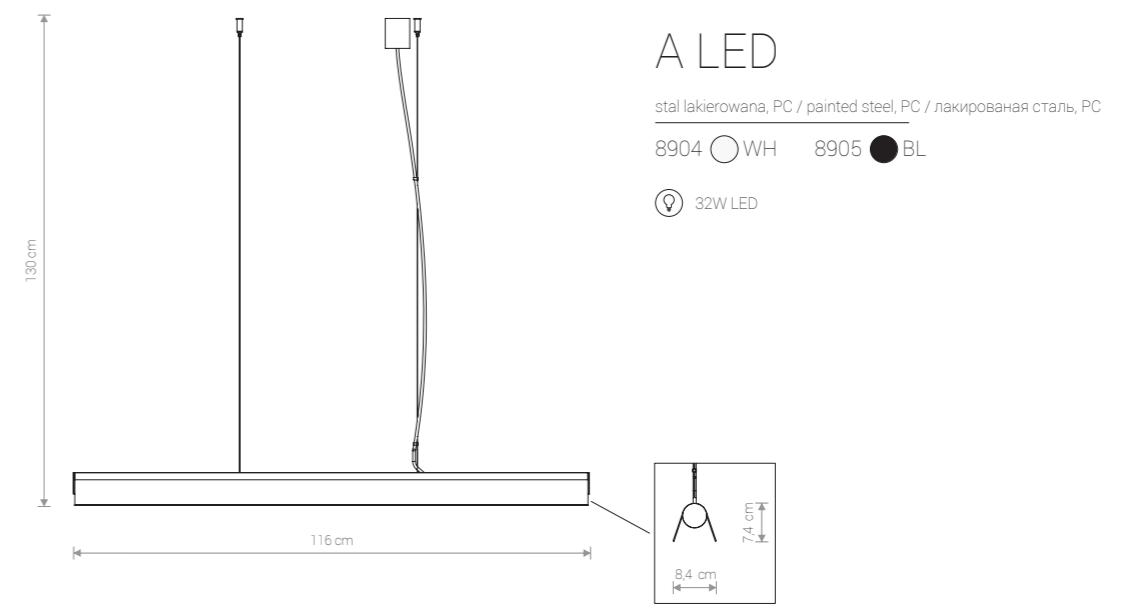
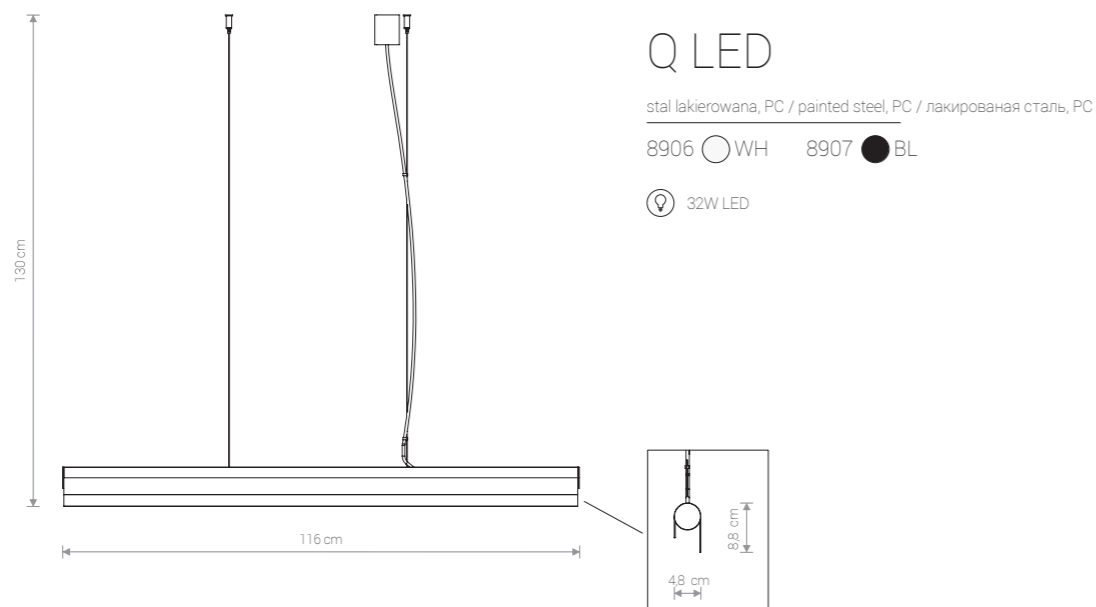

Item No.	INPUT POWER	COLOUR TEMP.	LUMINOUS FLUX	LUMINAIRE EFFICIENCY	COLOUR RENDERING INDEX (CRI ≥)	INPUT	LIFETIME
8906, 8907	36W LED	3000K	2700 lm	75	80	~230V, 50Hz	50 000 h

Item No.	INPUT POWER	COLOUR TEMP.	LUMINOUS FLUX	LUMINAIRE EFFICIENCY	COLOUR RENDERING INDEX (CRI ≥)	INPUT	LIFETIME
8904, 8905	36W LED	3000K	2700 lm	75	80	~230V, 50Hz	50 000 h



SOFT LED 90x6 9545 WH

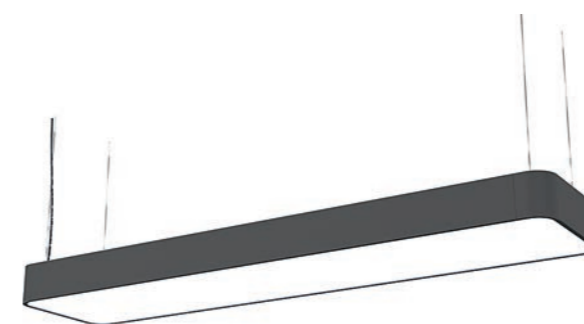

SOFT LED 90x20 9542 GR

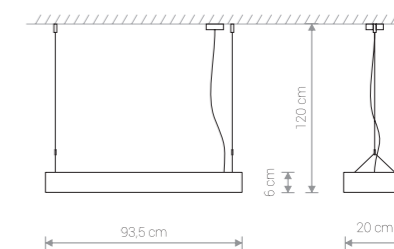

SOFT LED 90x20

aluminium, PC / aluminium, PC / алюминия, PC

9544 ○ WH 9542 ● GR

⊖ 2xT8 LED, 16W, included



SOFT LED 90x6 9545 WH

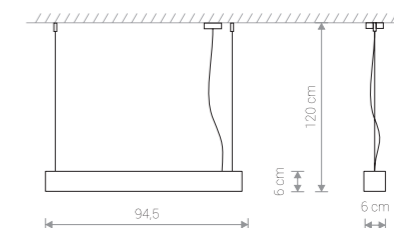

SOFT LED 90x6

aluminium, PC / aluminium, PC / алюминия, PC

9545 ○ WH 9546 ● GR

⊖ 1xT8 LED, 16W, included

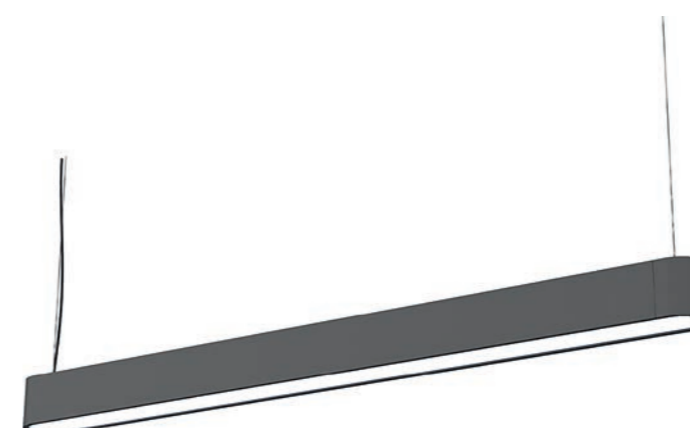

SOFT LED 120x6 9543 GR

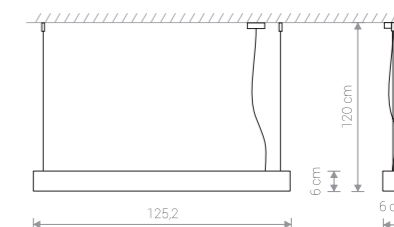

SOFT LED 120x6

aluminium, PC / aluminium, PC / алюминия, PC

9547 ○ WH 9543 ● GR

⊖ 1xT8 LED, 22W, included

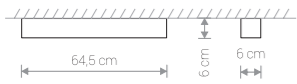

SOFT LED 60×6

aluminium, PC / aluminium, PC / алюминия, PC

9541 ○ WH 9537 ● GR

⊖ 1×T8 LED, 11W, **included**

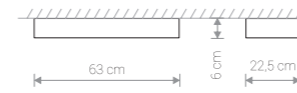

SOFT LED 60×20

aluminium, PC / aluminium, PC / алюминия, PC

9534 ○ WH 9532 ● GR

⊖ 2×T8 LED, 11W, **included**



SOFT LED 60×6 9527 WH



SOFT LED 60×6

aluminium, PC / aluminium, PC / алюминия, PC

9527 ○ WH 9525 ● GR

⊖ 1×T8 LED, 11W, **included**

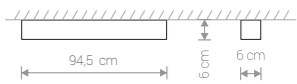

SOFT LED 90×6

aluminium, PC / aluminium, PC / алюминия, PC

9540 ○ WH 9536 ● GR

⊖ 1×T8 LED, 16W, **included**

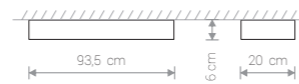

SOFT LED 90×20

aluminium, PC / aluminium, PC / алюминия, PC

9533 ○ WH 9531 ● GR

⊖ 2×T8 LED, 16W, **included**



SOFT LED 90×6 9524 GR



SOFT LED 90×6

aluminium, PC / aluminium, PC / алюминия, PC

9526 ○ WH 9524 ● GR

⊖ 1×T8 LED, 16W, **included**

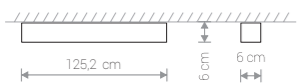

SOFT LED 120×6

aluminium, PC / aluminium, PC / алюминия, PC

9538 ○ WH 9535 ● GR

⊖ 1×T8 LED, 22W, **included**

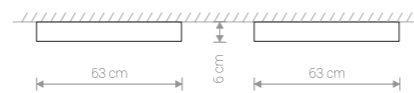

SOFT LED 60×60

aluminium, PC / aluminium, PC / алюминия, PC

9530 ○ WH 9528 ● GR

⊖ 5×T8 LED, 11W, **included**



SOFT LED 60×20 9523 WH



SOFT LED 60×20

aluminium, PC / aluminium, PC / алюминия, PC

9523 ○ WH 9522 ● GR

⊖ 2×T8 LED, 11W, **included**

NAME	SIZE	POWER	COLOUR TEMP.	LUMINOUS FLUX	BEAM ANGLE	COLOUR RENDERING INDEX (CRI >)	INPUT	POWER FACTOR	LIFETIME	MATERIAL
LED TUBE T8	60 cm	11W	3000K	950-1000 lm	200°	80	~230V, 50Hz	> 0,9	25 000 h	CLEAR GLASS
LED TUBE T8	90 cm	16W	3000K	1400-1500 lm	200°	80	~230V, 50Hz	> 0,9	25 000 h	CLEAR GLASS
LED TUBE T8	120 cm	22W	3000K	2000-2100 lm	200°	80	~230V, 50Hz	> 0,9	25 000 h	CLEAR GLASS



OFFICE LED 9358 WH



HALL LED 9466 WH



OFFICE LED

aluminium / aluminium / алюминия

9358 ○ WH 9360 ● GR

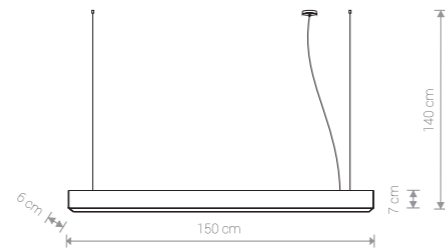

OFFICE LED

aluminium / aluminium / алюминия

9355 ○ WH 9356 ● GR

**CertaFlux LED Strip and CertaDrive
made by PHILIPS inside**

**LIFETIME min 50 000 h
5 YEARS WARRANTY**



HALL LED

aluminium / aluminium / алюминия

9466 ○ WH 9357 ● GR

NAME	SIZE	INPUT POWER	COLOUR TEMP.	LUMINOUS FLUX	LUMINAIRE EFFICIENCY	COLOUR RENDERING INDEX (CRI ≥)	INPUT	LIFETIME
HALL LED	150 cm	43W	4000K	5200 lm	120 lm/W	80	~230V, 50Hz	50 000 h
OFFICE LED	150 cm	43W	4000K	4800 lm	110 lm/W	80	~230V, 50Hz	50 000 h

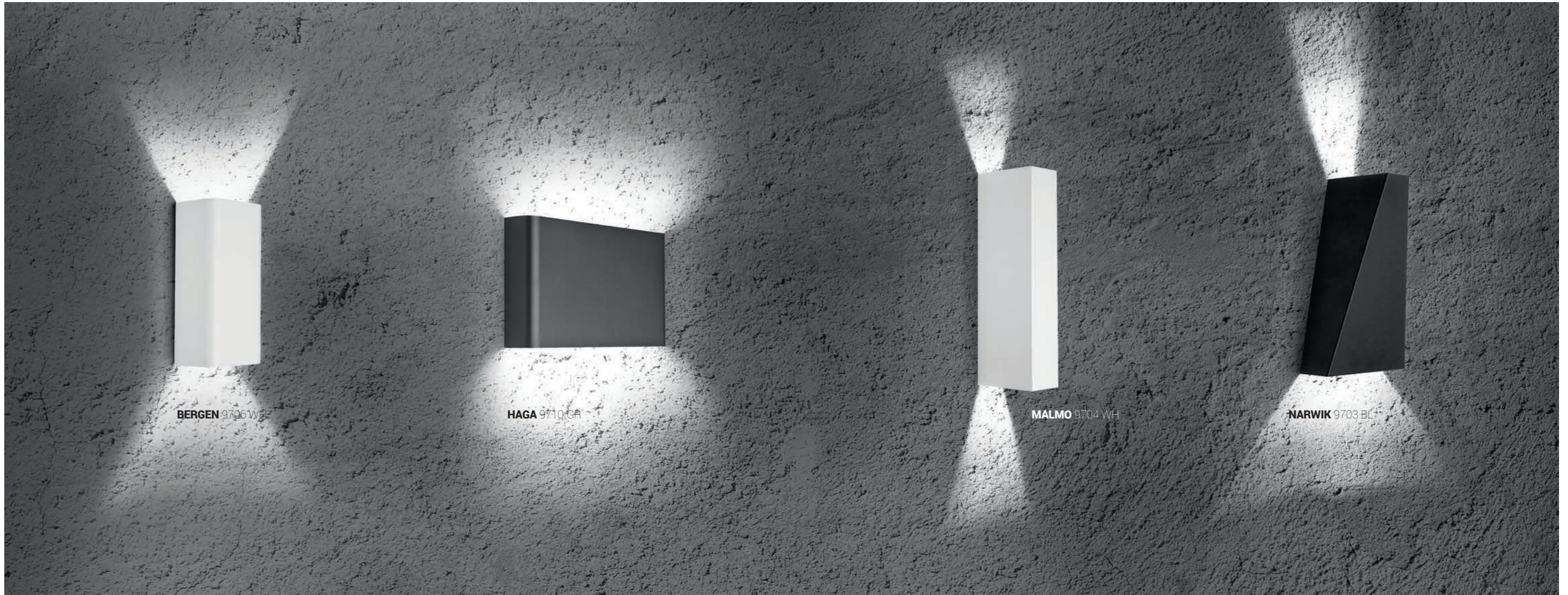

BERGEN 9706 WH

HAGA 9710 GR

MALMO 9704 WH

NARWIK 9703 BL

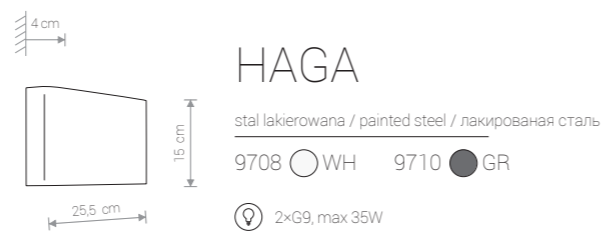



WING LED 9248 GR



TUBE 9318 GR



WING LED 9295WH

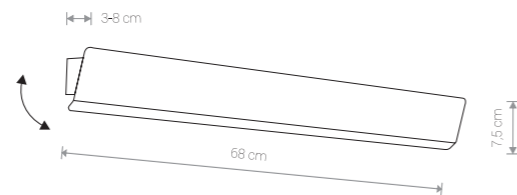

WING LED

stal lakierowana / painted steel / лакированная сталь

9295 ○ WH 9248 ● GR 9250 ● BL

⊖ 1×T8 LED, 11W, included

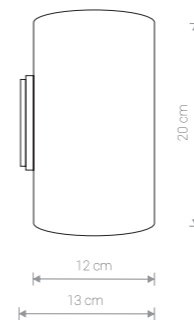

TUBE

aluminium lakierowane / painted aluminium / лакированное алюминий

9317 ○ WH 9318 ● GR 9320 ● BL

⊖ 2×GU10, ES111, max 75W



TUBE 9320 BL

NAME	SIZE	POWER	COLOUR TEMP.	LUMINOUS FLUX	BEAM ANGLE	COLOUR RENDERING INDEX (CRI >)	INPUT	POWER FACTOR	LED DRIVER	LIFETIME	MATERIAL
LED TUBE T8	60 cm	11W	3000K	950-1000 lm	200°	80	~230V, 50Hz	> 0,9	INCL.	25 000 h	CLEAR GLASS

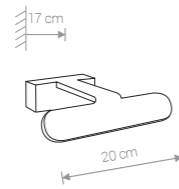
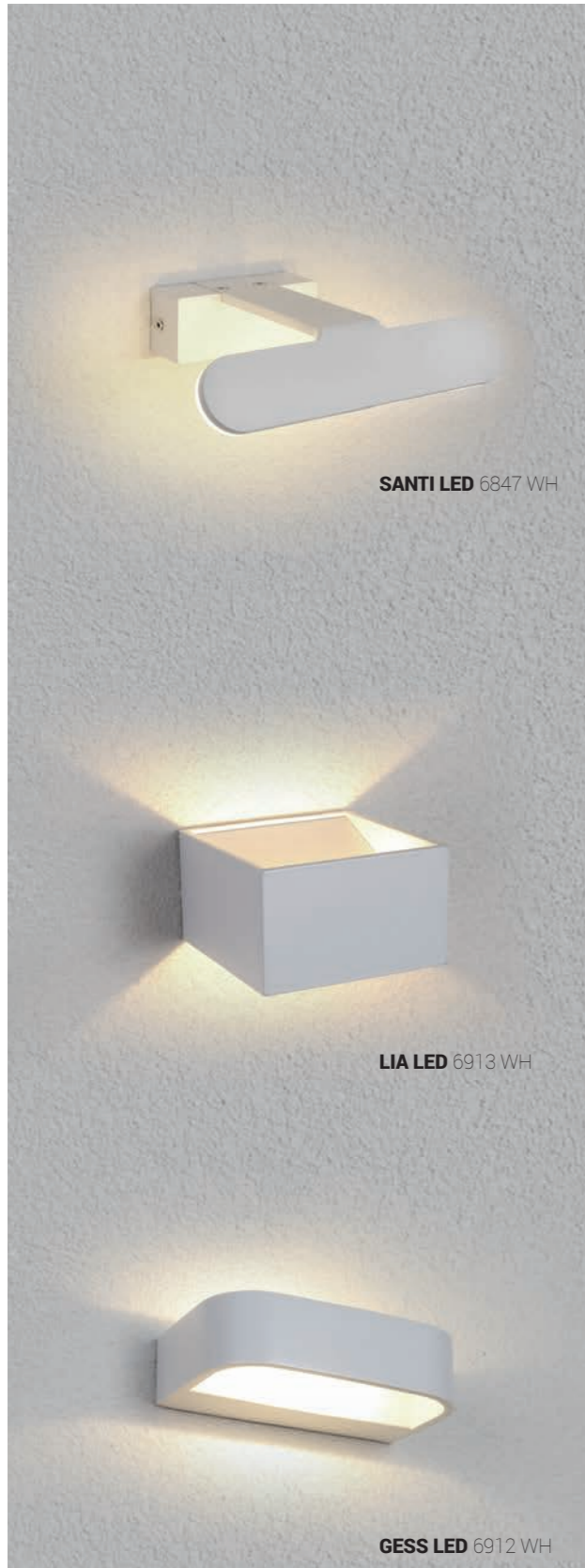

SANTI LED
aluminium / aluminum / алюминий
6847 ○ WH

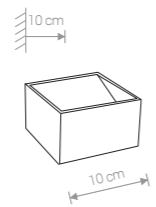

LIA LED
aluminium / aluminum / алюминий
6913 ○ WH

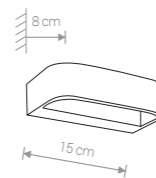

GESS LED
aluminium / aluminum / алюминий
6912 ○ WH

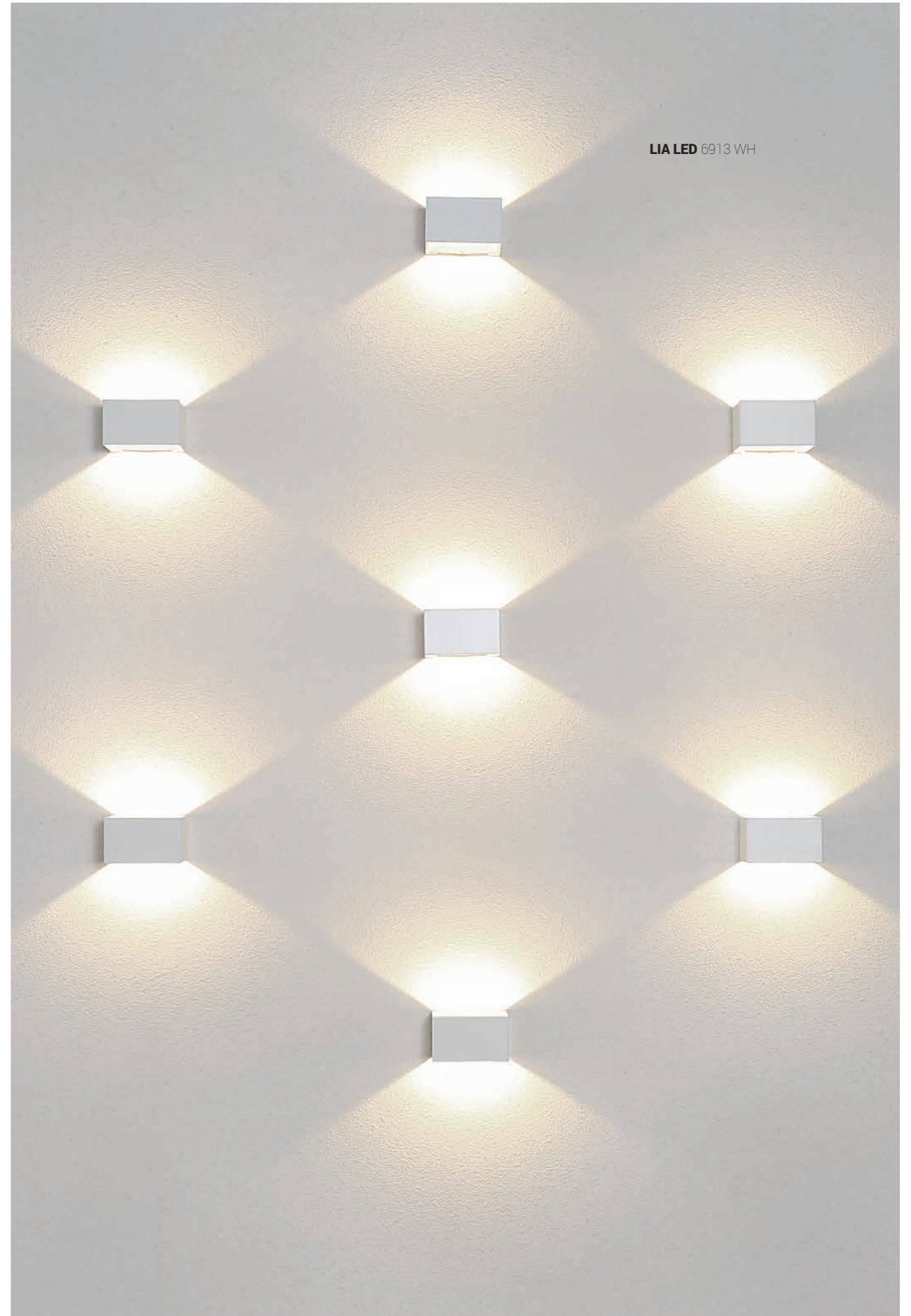

LIA LED 6913 WH

Item No.	POWER	COLOUR TEMP.	LUMINOUS FLUX	BEAM ANGLE	COLOUR RENDERING INDEX (CRI >)	INPUT	SAFETY TYPE	INGRESS PROTECTION
6847	1x6W LED EPISTAR	300K	612 lm	100°	80	~220-240V, 50Hz	⊕	IP 20
6913	1x6W LED EPISTAR	300K	648 lm	89°	80	~220-240V, 50Hz	⊕	IP 20
6912	1x6W LED EPISTAR	300K	615 lm	47°	80	~220-240V, 50Hz	⊕	IP 20

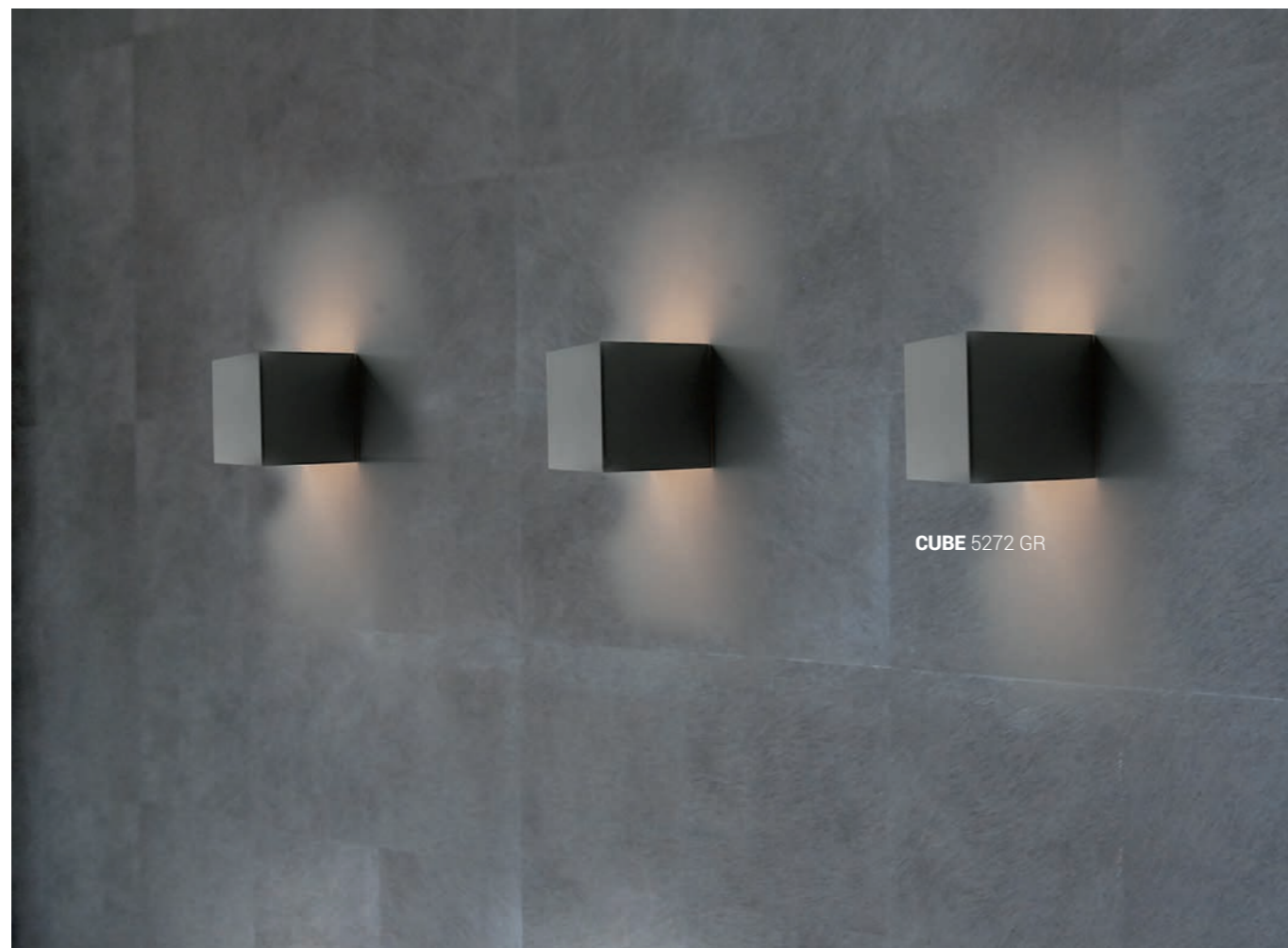

CUBE 5272 GR



CUBE 5266 WH



CUBE 5267 SI



CUBE 5272 GR

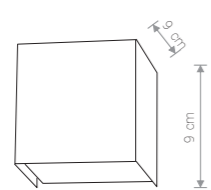

CUBE

stal lakierowana, szkło / painted steel, glass / лакирована сталь, стекло

5266 ○ WH 5267 ○ SI 5272 ● GR

1×G9, max 50W

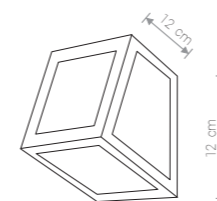

VER

sklejka, szkło / plywood, glass / дерево, стекло

5330 ○ WH 5332 ● WE

1×G9, max 40W

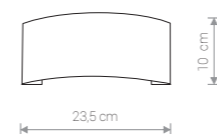

KEAL GOLD S

aluminium / aluminium / алюминий

2985 ● G

1×G9, max 40W



VER 5332 WE

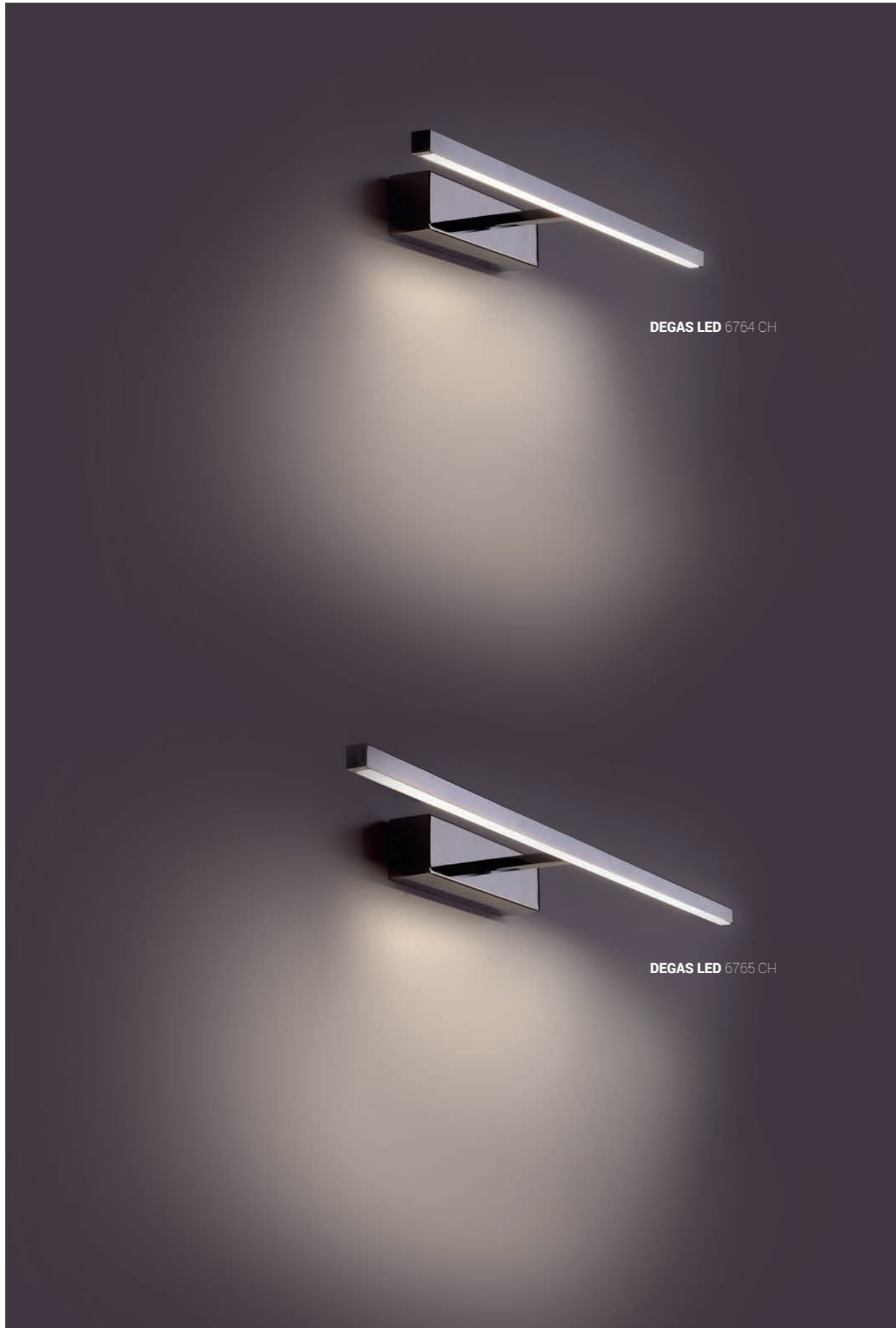

DEGAS LED 6764 CH

DEGAS LED 6765 CH



MONET LED S 5133 CH



MONET LED M 5134 CH

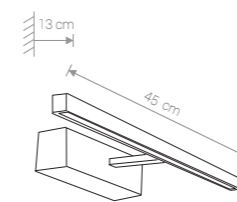

DEGAS LED S

stal chromowana / electroplated steel / хромированная сталь

6764 ● CH

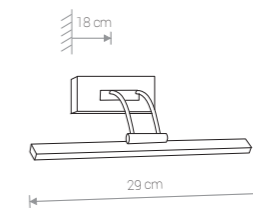

MONET LED S

stal chromowana / electroplated steel / хромированная сталь

5133 ● CH

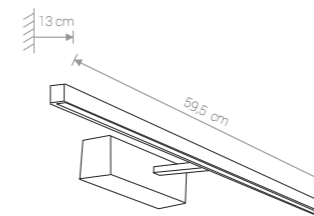

DEGAS LED M

stal chromowana / electroplated steel / хромированная сталь

6765 ● CH

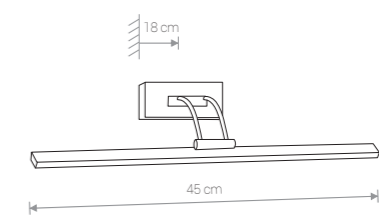

MONET LED M

stal chromowana / electroplated steel / хромированная сталь

5134 ● CH

Item No.	POWER	COLOUR TEMP.	LUMINOUS FLUX	BEAM ANGLE	COLOUR RENDERING INDEX (CRI →)	INPUT	SAFETY TYPE	INGRESS PROTECTION
6764	40×0,2W LED	3000K	370 lm	120°	80	~80-265V, 50Hz	⊕	IP 20
6765	60×0,2W LED	3000K	560 lm	120°	80	~80-265V, 50Hz	⊕	IP 20
5133	25×0,2W LED	3000K	345 lm	120°	80	~80-265V, 50Hz	⊕	IP 20
5134	40×0,2W LED	3000K	555 lm	120°	80	~80-265V, 50Hz	⊕	IP 20



GOYA LED 6848 WH

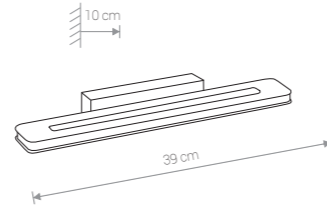

GOYA LED

stal lakierowana, tworzywo sztuczne / steel, plastic / сталь, пластик

6848 ○ WH



GAUDI LED S 6850 CH

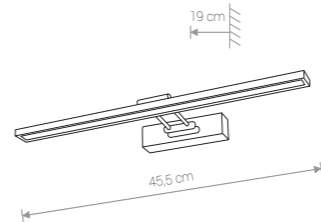

GAUDI LED S

stal chromowana / electroplated steel / хромированная сталь

6850 ● CH

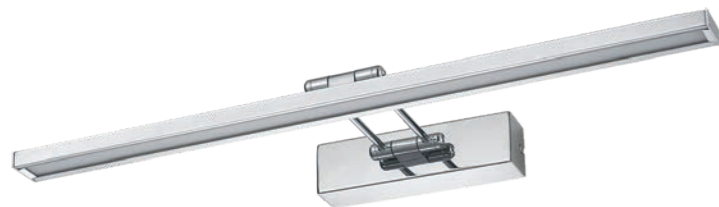

GAUDI LED M 6851 CH

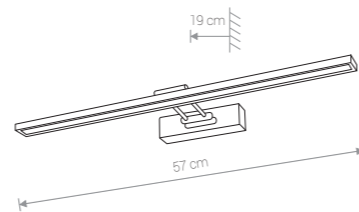

GAUDI LED M

stal chromowana / electroplated steel / хромированная сталь

6851 ● CH



KASAI 9491 N

KASAI 9490 CH

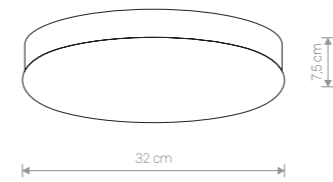

KASAI

szkło, stal chromowana / glass, electroplated steel / стекло, хромированная сталь

9490 ● CH

⚡ 2×E27, max 40W

IP 20

szkło, stal niklowana / glass, nickel-plated steel / стекло, сталь никелированная

9491 ● N

⚡ 2×E27, max 40W

IP 20

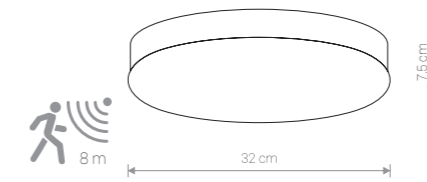

KASAI SENSOR

szkło, stal chromowana / glass, electroplated steel / стекло, хромированная сталь

8827 ● CH

⚡ 2×E27, max 40W

IP 20

szkło, stal niklowana / glass, nickel-plated steel / стекло, сталь никелированная

8828 ● N

⚡ 2×E27, max 40W

IP 20

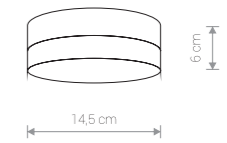

TUGELA

szkło, stal chromowana / glass, electroplated steel / стекло, хромированная сталь

9492 ● CH

⚡ 1×G9, max 40W, **included**

IP 20

szkło, stal niklowana / glass, nickel-plated steel / стекло, сталь никелированная

9493 ● N

⚡ 1×G9, max 40W, **included**

IP 20



TUGELA 9492 CH

TUGELA 9493 N

Item No.	POWER	COLOUR TEMP.	LUMINOUS FLUX	BEAM ANGLE	COLOUR RENDERING INDEX (CRI >)	INPUT	SAFETY TYPE	POWER FACTOR	INGRESS PROTECTION
6848	80×0,1W LED	3000K	482 lm	120°	80	~80-265V, 50Hz	⊕	0,5	IP20
6851	60×0,2W LED	3000K	532 lm	120°	80	~80-265V, 50Hz	⊕	0,5	IP20
6850	40×0,2W LED	3000K	310 lm	120°	80	~80-265V, 50Hz	⊕	0,5	IP20



AGNES ROUND LED 9160 WH

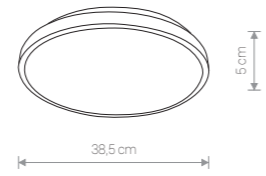

AGNES ROUND LED

stal lakierowana, PMMA / steel painted, PMMA / лакированная сталь, PMMA

9160 ○ WH 9161 ● BL



AGNES SQUARE LED 9167 BL

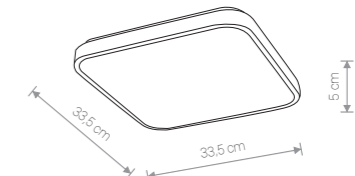

AGNES SQUARE LED

stal lakierowana, PMMA / steel painted, PMMA / лакированная сталь, PMMA

9166 ○ WH 9167 ● BL



AGNES ROUND LED 9162 WH

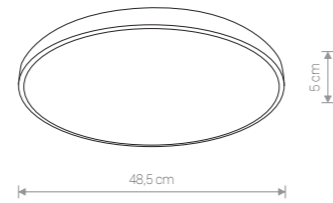

AGNES ROUND LED

stal lakierowana, PMMA / steel painted, PMMA / лакированная сталь, PMMA

9162 ○ WH 9163 ● BL



AGNES SQUARE LED 9170 BL

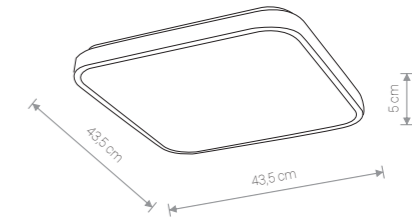

AGNES SQUARE LED

stal lakierowana, PMMA / steel painted, PMMA / лакированная сталь, PMMA

9168 ○ WH 9170 ● BL



AGNES ROUND LED 9164 WH

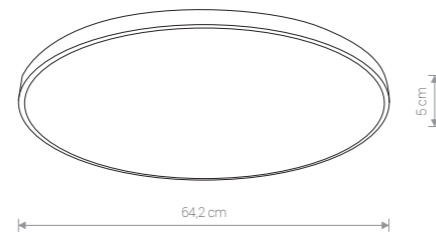

AGNES ROUND LED

stal lakierowana, PMMA / steel painted, PMMA / лакированная сталь, PMMA

9164 ○ WH 9165 ● BL



AGNES SQUARE LED 9171 WH

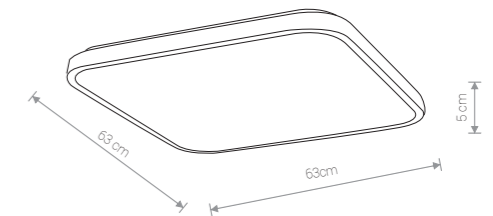

AGNES SQUARE LED

stal lakierowana, PMMA / steel painted, PMMA / лакированная сталь, PMMA

9171 ○ WH 9172 ● BL

Item No.	POWER	COLOUR TEMP.	LUMINOUS FLUX	BEAM ANGLE	COLOUR RENDERING INDEX (CRI >)	INPUT	SAFETY TYPE	POWER FACTOR	INGRESS PROTECTION	LIFETIME
9160, 9161	22W	4000K	2000 lm	120°	80	~200-240V, 50Hz	⊕	> 0,9	IP 20	20 000 h
9162, 9163	32W	4000K	2900 lm	120°	80	~200-240V, 50Hz	⊕	> 0,9	IP 20	20 000 h
9164, 9165	64W	4000K	6000 lm	120°	80	~200-240V, 50Hz	⊕	> 0,9	IP 20	20 000 h

Item No.	POWER	COLOUR TEMP.	LUMINOUS FLUX	BEAM ANGLE	COLOUR RENDERING INDEX (CRI >)	INPUT	SAFETY TYPE	POWER FACTOR	INGRESS PROTECTION	LIFETIME
9166, 9167	16W	4000K	1500 lm	120°	80	~200-240V, 50Hz	⊕	> 0,9	IP 20	20 000 h
9168, 9170	32W	4000K	2900 lm	120°	80	~200-240V, 50Hz	⊕	> 0,9	IP 20	20 000 h
9171, 9172	64W	4000K	6000 lm	120°	80	~200-240V, 50Hz	⊕	> 0,9	IP 20	20 000 h



BIG BOY 6301 WH

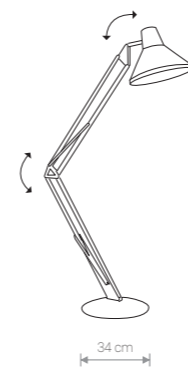

BIG BOY

stal lakierowana / painted steel / лакированная сталь

6301 ○ WH

Ⓛ 1xE27, max 100W



TAMPA

stal lakierowana / painted steel / лакированная сталь

5800 ○ SI

Ⓛ 1xE27, max 18W



TAMPA 5800 SI



COSMO S 4917 CH



COSMO S 3382 SI



COSMO S

stal / steel / сталь

3382 ● SI

① 1×E27, max 60W

stal chromowana / electroplated steel / хромированная сталь

4917 ● CH

① 1×E27, max 60W



COSMO S 3382 SI



POCATELLO 5798 PI



POCATELLO 5796 GN



POCATELLO 5797 TU



POCATELLO 5795 SI

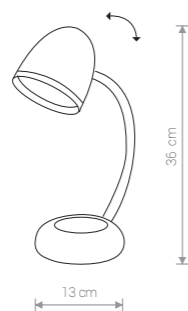

POCATELLO

stal lakierowana, stal chromowana / painted steel, electroplated steel /
лакированная сталь, хромированная сталь

- | | | | | | |
|------|----|------|----|------|----|
| 5798 | PI | 5794 | WH | 5795 | SI |
| 5797 | TU | 5796 | GN | 5828 | BL |

1×E27, max 18W



STUDENT 6227 SI

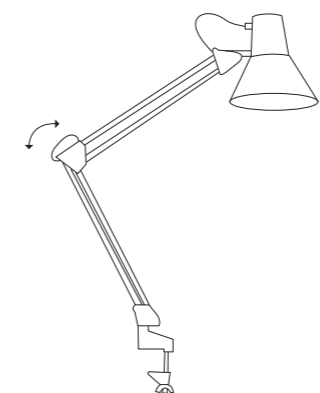

STUDENT

stal lakierowana / painted steel / лакированная сталь

- | | | | | | |
|--------|----|--------|----|------|----|
| 002/00 | WH | 002/01 | BL | 6227 | SI |
|--------|----|--------|----|------|----|

1×E27, max 60W



profile
system



PROFILE IRIS LED 7W 8996 BL

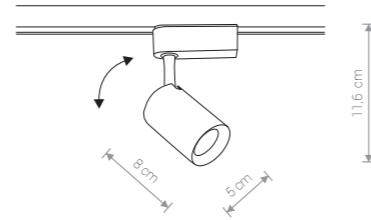

PROFILE IRIS LED 7W

aluminium / aluminium / алюминия

- 8995 ○ WH - 3000K 8996 ● BL - 3000K
8997 ○ WH - 4000K 8998 ● BL - 4000K



PROFILE IRIS LED 20W 9005 BL

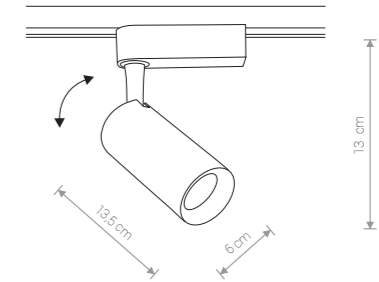

PROFILE IRIS LED 20W

aluminium / aluminium / алюминия

- 9004 ○ WH - 3000K 9005 ● BL - 3000K
9006 ○ WH - 4000K 9007 ● BL - 4000K



PROFILE IRIS LED 12W 9000 WH

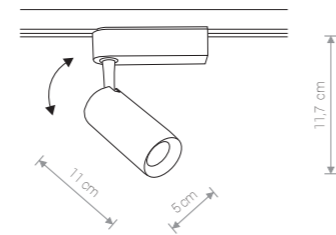

PROFILE IRIS LED 12W

aluminium / aluminium / алюминия

- 9000 ○ WH - 3000K 9001 ● BL - 3000K
9002 ○ WH - 4000K 9003 ● BL - 4000K



PROFILE IRIS LED 30W 9008 WH

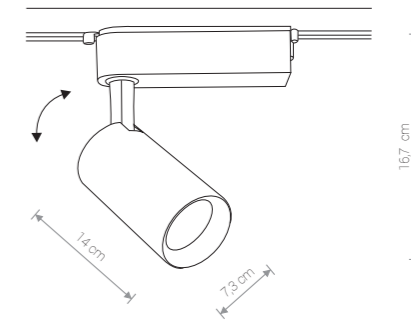

PROFILE IRIS LED 30W

aluminium / aluminium / алюминия

- 9008 ○ WH - 3000K 9009 ● BL - 3000K
9010 ○ WH - 4000K 9011 ● BL - 4000K

Item No.	POWER	COLOUR TEMP.	LUMINOUS FLUX	BEAM ANGLE	COLOUR RENDERING INDEX (CRI >=)	INPUT	SAFETY TYPE	POWER FACTOR	INGRESS PROTECTION	LIFETIME
8995, 8996	7W LED	3000K	420 lm	30°	80	~200-240V, 50Hz	■	0,5	IP 20	30 000 h
8997, 8998	7W LED	4000K	420 lm	30°	80	~200-240V, 50Hz	■	0,5	IP 20	30 000 h
9000, 9001	12W LED	3000K	864 lm	30°	80	~200-240V, 50Hz	■	0,5	IP 20	30 000 h
9002, 9003	12W LED	4000K	864 lm	30°	80	~200-240V, 50Hz	■	0,5	IP 20	30 000 h

Item No.	POWER	COLOUR TEMP.	LUMINOUS FLUX	BEAM ANGLE	COLOUR RENDERING INDEX (CRI >=)	INPUT	SAFETY TYPE	POWER FACTOR	INGRESS PROTECTION	LIFETIME
9004, 9005	20W LED	3000K	1360 lm	30°	80	~200-240V, 50Hz	■	0,5	IP 20	30 000 h
9006, 9007	20W LED	4000K	1360 lm	30°	80	~200-240V, 50Hz	■	0,5	IP 20	30 000 h
9008, 9009	30W LED	3000K	1950 lm	30°	80	~200-240V, 50Hz	■	0,9	IP 20	30 000 h
9010, 9011	30W LED	4000K	1950 lm	30°	80	~200-240V, 50Hz	■	0,9	IP 20	30 000 h

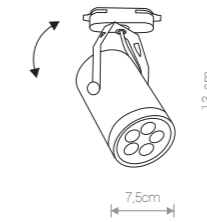
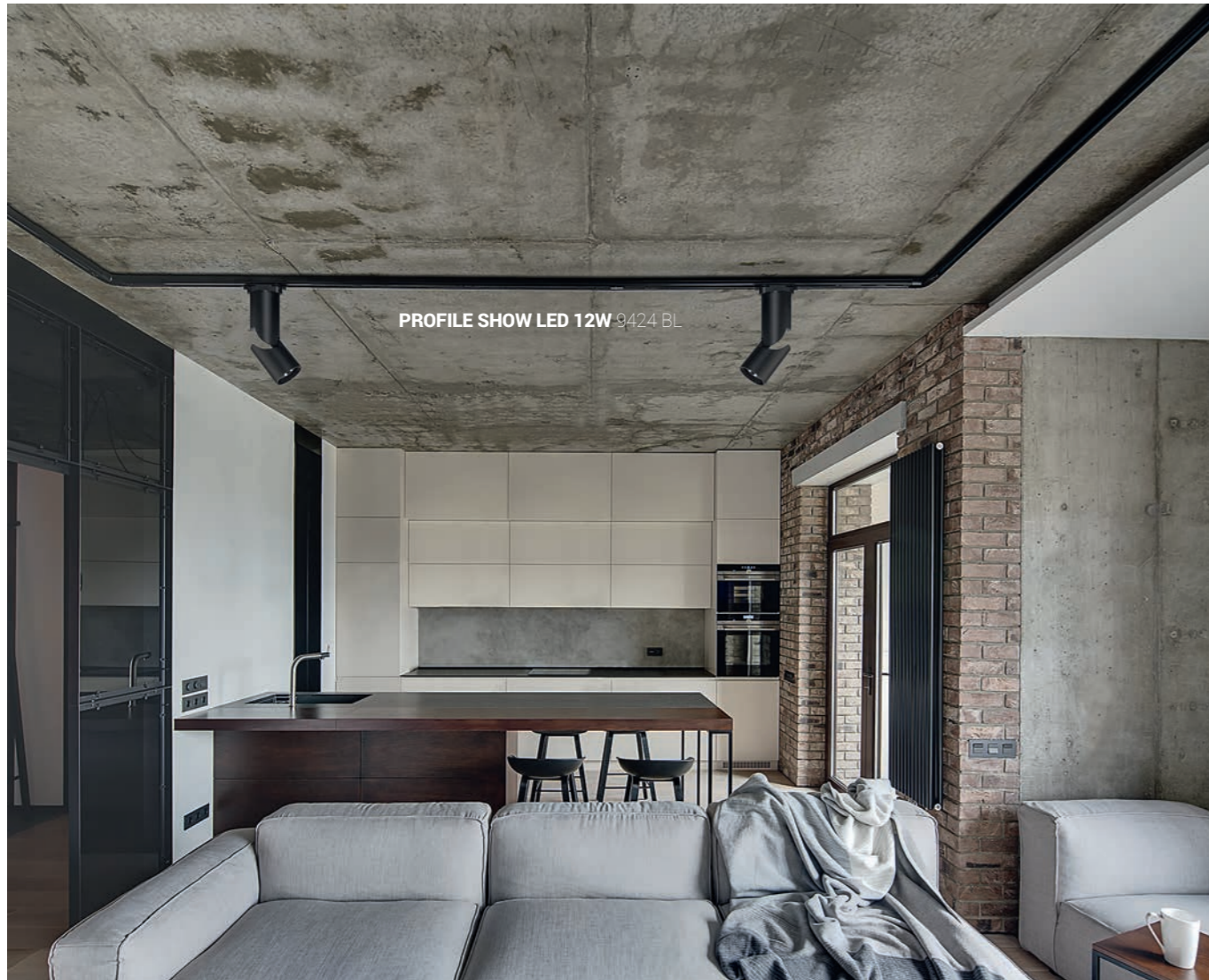

PROFILE STORE LED 5W

stal lakierowana / painted steel / лакирована сталь

5947 ○ WH 6824 ● BL

PROFILE STORE LED 5W 6824 BL

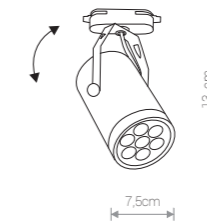

PROFILE STORE LED 7W

stal lakierowana / painted steel / лакирована сталь

5948 ○ WH 6825 ● BL

PROFILE STORE LED 7W 6825 BL

PROFILE SHOW LED 12W 9423 WH

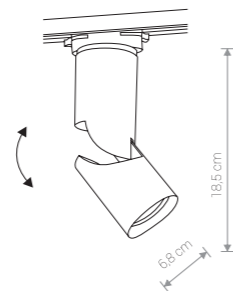

PROFILE SHOW LED 12W

aluminium / aluminium / алюминия

9423 ○ WH 9424 ● BL

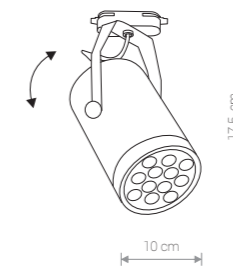

PROFILE STORE LED 12W

stal lakierowana / painted steel / лакирована сталь

5950 ○ WH 6826 ● BL

PROFILE STORE LED 12W 5950 WH

Item No.	POWER	COLOUR TEMP.	LUMINOUS FLUX	BEAM ANGLE	COLOUR RENDERING INDEX (CRI >)	INPUT	SAFETY TYPE	POWER FACTOR	INGRESS PROTECTION	LIFETIME
9423, 9424	1x12W COB LED	4000K	1500 - 1650 lm	24°	80	~200-240V, 50Hz	□	0.5	IP 20	8 000 h

Item No.	POWER	COLOUR TEMP.	LUMINOUS FLUX	BEAM ANGLE	COLOUR RENDERING INDEX (CRI >)	INPUT	SAFETY TYPE	POWER FACTOR	INGRESS PROTECTION	LIFETIME
5947, 6824	5x1W LED	4000K	450 - 500 lm	30°	80	~200-240V, 50Hz	□	> 0.5	IP 20	8 000 h
5948, 6825	7x1W LED	4000K	630 - 700 lm	30°	80	~200-240V, 50Hz	□	> 0.5	IP 20	8 000 h
5950, 6826	12x1W LED	4000K	1080 - 1200 lm	30°	80	~200-240V, 50Hz	□	> 0.5	IP 20	8 000 h



PROFILE BUBLE 9336 BL

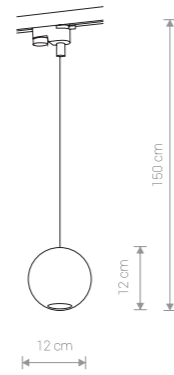

PROFILE BUBBLE

stal lakierowana / painted steel / лакированная сталь

9335 ○ WH 9336 ● BL

1×GU10, max 35W



PROFILE BIT 8822 WH

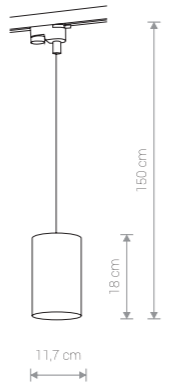

PROFILE BIT

stal lakierowana / painted steel / лакированная сталь

8822 ○ WH 8823 ● BL

1×GU10, ES111, max 75W



PROFILE WORKSHOP 9427 BL/CO

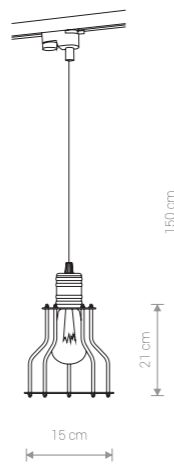

PROFILE WORKSHOP

stal lakierowana / painted steel / лакированная сталь

9427 ● BL/CO

1×E27, max 60W



PROFILE EYE 9338 BL

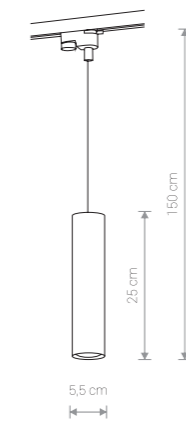

PROFILE EYE

stal lakierowana / painted steel / лакированная сталь

9337 ○ WH 9338 ● BL

1×GU10, max 35W

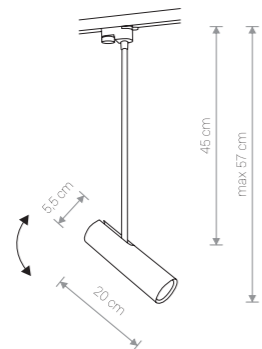

PROFILE EYE SUPER A

stal lakierowana / painted steel / лакированная сталь

9324 ○ WH 9325 ● BL

Ⓧ 1×GU10, max 35W

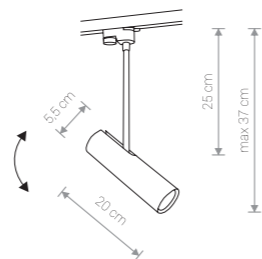

PROFILE EYE SUPER C

stal lakierowana / painted steel / лакированная сталь

9245 ○ WH 9244 ● BL

Ⓧ 1×GU10, max 35W

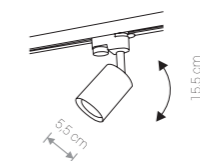

PROFILE EYE SPOT

stal lakierowana / painted steel / лакированная сталь

9321 ○ WH 9322 ● BL

Ⓧ 1×GU10, max 35W

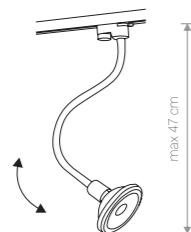

PROFILE FLEX

peszel, stal lakierowana / protective pipe, painted steel / кабель-канал, лакированная сталь

9328 ○ WH 9330 ● BL

Ⓧ 1×GU10, max 35W

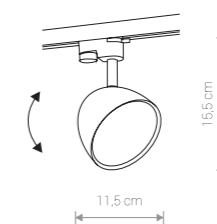

PROFILE VESPA

stal lakierowana / painted steel / лакированная сталь

8824 ○ WH 8825 ● BL

Ⓧ 1×GU10, ES111, max 75W

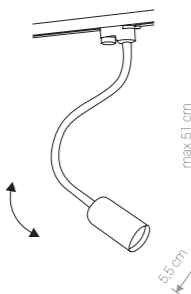

PROFILE EYE FLEX

peszel, stal lakierowana / protective pipe, painted steel / кабель-канал, лакированная сталь

9331 ○ WH 9332 ● BL

Ⓧ 1×GU10, max 35W

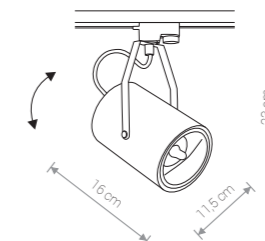

PROFILE BIT PLUS

stal lakierowana / painted steel / лакированная сталь

9020 ○ WH 9018 ● BL

Ⓧ 1×GU10, ES111, max 75W



PROFILE IRIS LED 12W 9000 WH

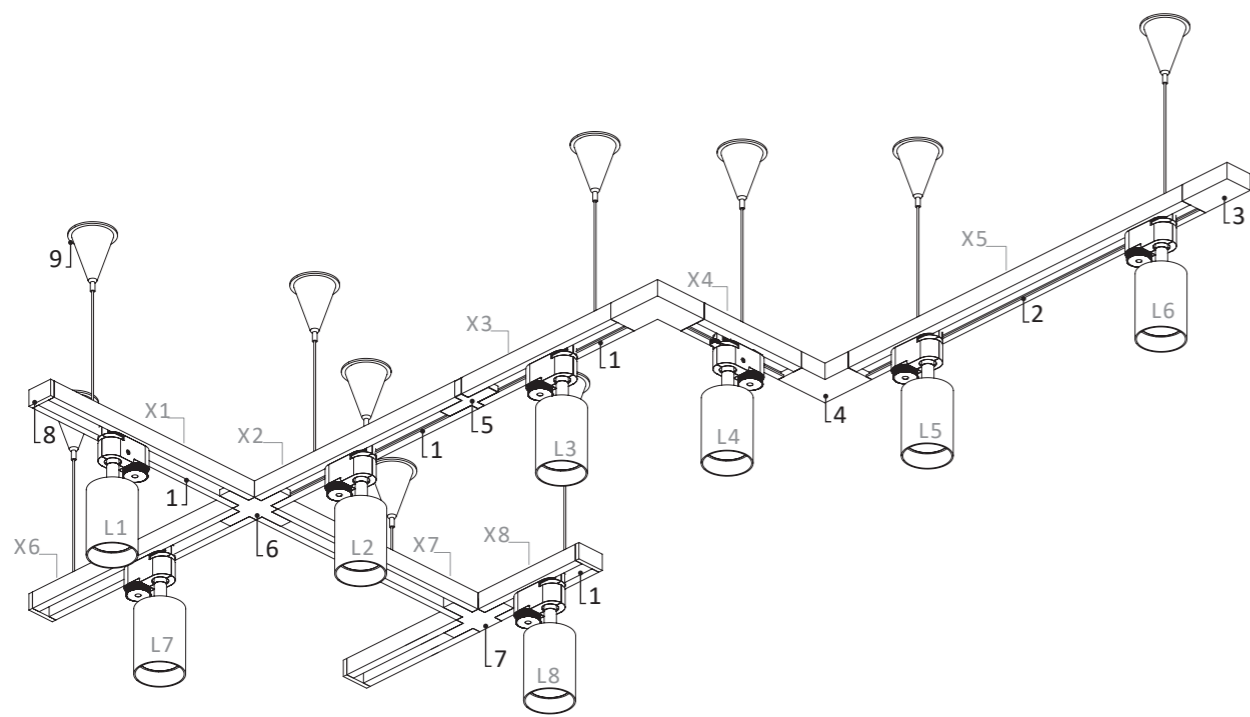

PROFILE TRACK LIGHTS SYSTEM	BLACK	WHITE
1. PROFILE TRACK 1 METER	9448	9450
2. PROFILE TRACK 2 METER	9452	9451
3. PROFILE POWER END CAP	9463	9462
4. PROFILE L-CONNECTOR	9455	9456
5. PROFILE STRAIGHT CONNECTOR	9453	9454
6. PROFILE X-CONNECTOR	9188	9190
7. PROFILE T-CONNECTOR	9186	9187
8. PROFILE DEAD END CAP	9458	9457
9. PROFILE SUSPENSION KIT	9460	9461

$X_1 + X_2 + X_3 + X_4 \dots = \text{max } 20 \text{ m}$
 $L_1 + L_2 + L_3 + L_4 \dots = \text{max } 1500 \text{ W}$

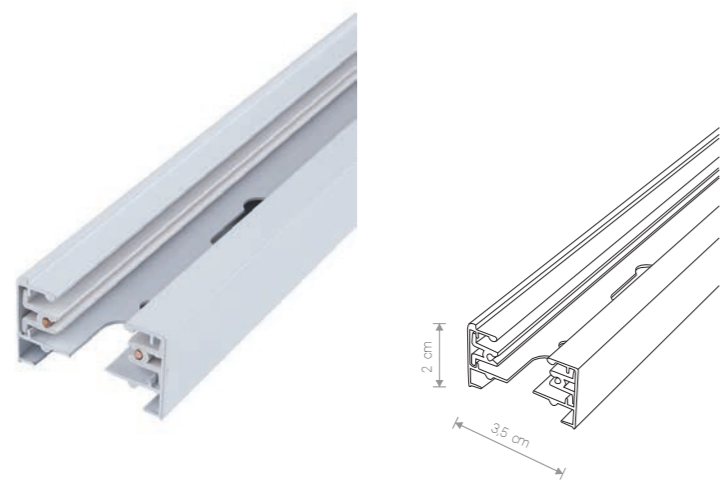

PROFILE TRACK 1 m

aluminium / aluminium / алюминия
 9450 ○ WH 9448 ● BL

PROFILE TRACK 2 m

aluminium / aluminium / алюминия
 9451 ○ WH 9452 ● BL

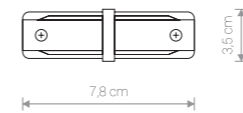

PROFILE STRAIGHT CONNECTOR

PC, miedz / PC, cooper / PC, медь
 9454 ○ WH 9453 ● BL

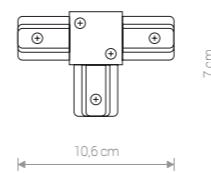

PROFILE T-CONNECTOR

PC, miedz / PC, cooper / PC, медь
 9187 ○ WH 9186 ● BL

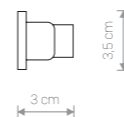

PROFILE DEAD END CAP

PC / PC / PC
 9457 ○ WH 9458 ● BL

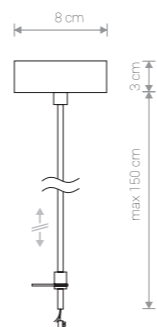

PROFILE POWER SUPPLY KIT

przewód, stal lakierowana / line, painted steel / проволока, лакированная сталь
 9237 ○ WH 9238 ● BL

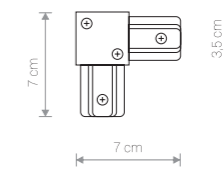

PROFILE L-CONNECTOR

PC, miedz / PC, cooper / PC, медь
 9456 ○ WH 9455 ● BL

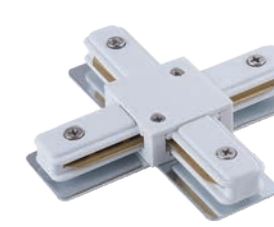
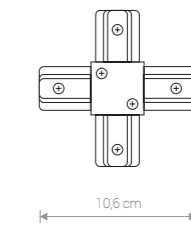

PROFILE X-CONNECTOR

PC, miedz / PC, cooper / PC, медь
 9190 ○ WH 9188 ● BL

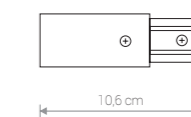

PROFILE POWER END CAP

PC, miedz / PC, cooper / PC, медь
 9462 ○ WH 9463 ● BL

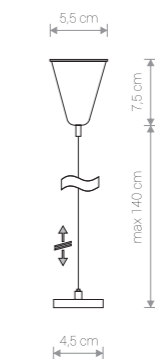

PROFILE SUSPENSION KIT

PC, stal / PC, steel / PC, сталь
 9461 ○ WH 9460 ● BL

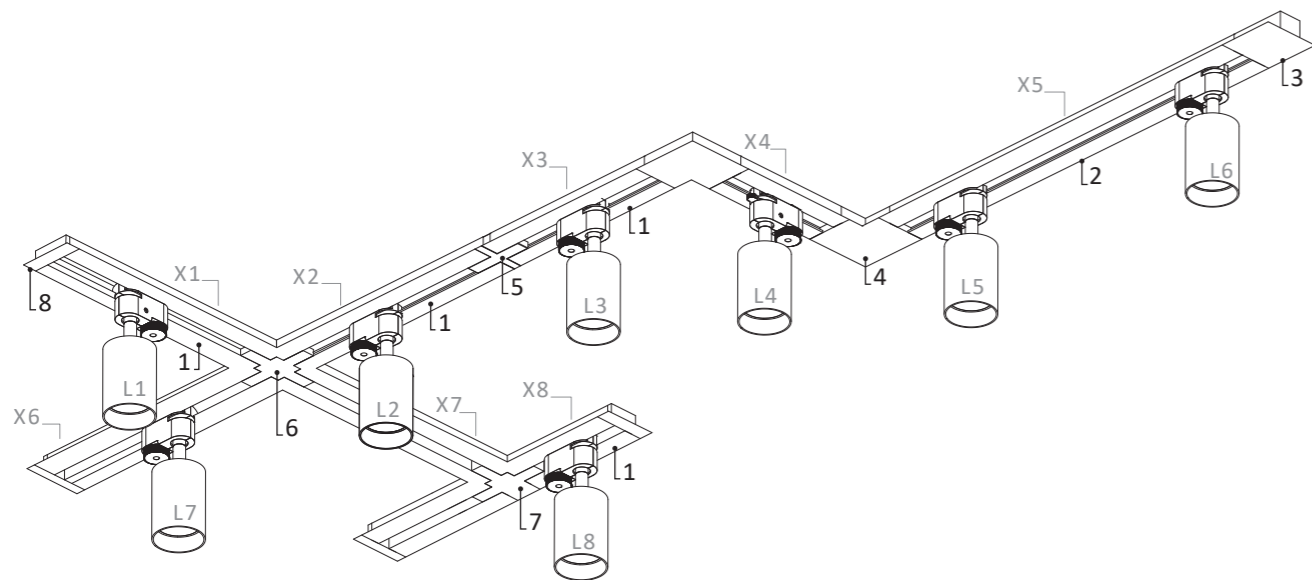

CEILING PANEL

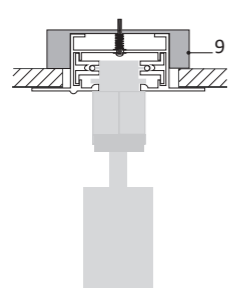

CEILING PANEL
cut out 45 mm x X

CEILING

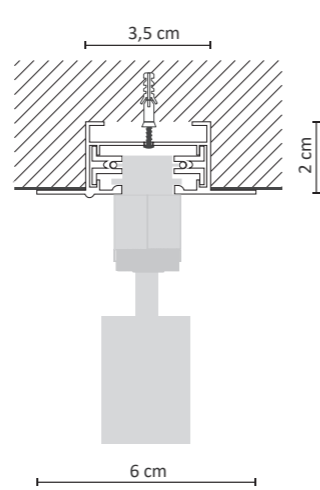

CEILING
cut out 35 mm x X

PROFILE RECESSED TRACK LIGHTS SYSTEM

- 1. PROFILE RECESSED TRACK 1 METER
- 2. PROFILE RECESSED TRACK 2 METER
- 3. PROFILE RECESSED POWER END CAP
- 4. PROFILE RECESSED L-CONNECTOR
- 5. PROFILE RECESSED STRAIGHT CONNECTOR
- 6. PROFILE RECESSED X-CONNECTOR
- 7. PROFILE RECESSED T-CONNECTOR
- 8. PROFILE RECESSED DEAD END CAP
- 9. PROFILE RECESSED FIXING SET

	BLACK	WHITE
1.	9013	9012
2.	9015	9014
3.	8973	8972
4.	8971	8970
5.	8968	8967
6.	8837	8836
7.	8835	8834
8.	8975	8974
9.	8805 GALVANIZED	

$X_1 + X_2 + X_3 + X_4 \dots = \text{max } 20 \text{ m}$
 $L_1 + L_2 + L_3 + L_4 \dots = \text{max } 1500 \text{ W}$

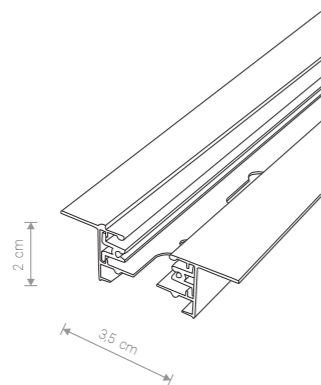

PROFILE RECESSED TRACK 1 m

aluminium / aluminium / алюминия
 9012 ○ WH 9013 ● BL

PROFILE RECESSED TRACK 2 m

aluminium / aluminium / алюминия
 9014 ○ WH 9015 ● BL

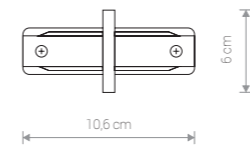

PROFILE RECESSED STRAIGHT CONNECTOR

PC, miedz / PC, cooper / PC, медь
 8967 ○ WH 8968 ● BL

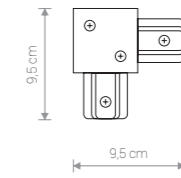

PROFILE RECESSED L-CONNECTOR

PC, miedz / PC, cooper / PC, медь
 8970 ○ WH 8971 ● BL

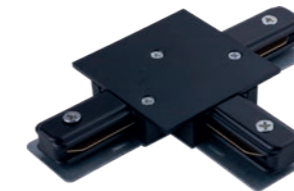
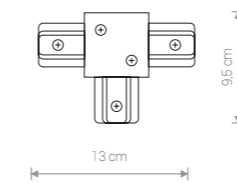

PROFILE RECESSED T-CONNECTOR

PC, miedz / PC, cooper / PC, медь
 8834 ○ WH 8835 ● BL

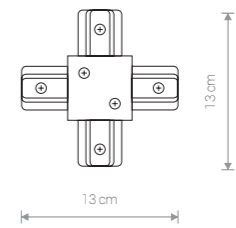

PROFILE RECESSED X-CONNECTOR

PC, miedz / PC, cooper / PC, медь
 8836 ○ WH 8837 ● BL

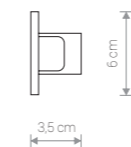

PROFILE RECESSED DEAD END CAP

PC / PC / PC
 8974 ○ WH 8975 ● BL

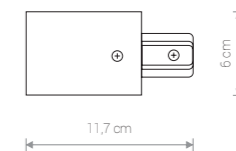

PROFILE RECESSED POWER END CAP

PC, miedz / PC, cooper / PC, медь
 8972 ○ WH 8973 ● BL

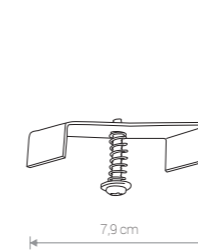

PROFILE RECESSED FIXING SET

stal / steel / сталь
 8805 ○ SI



spotlights
& downlights



CROSS 9604 WH/GR



CROSS 9596 GR/WH



CROSS 9603 WH/GR

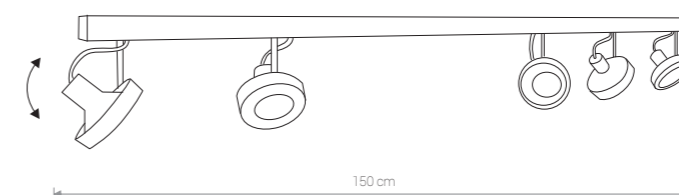

CROSS
stal lakierowana / painted steel / лакированная сталь
9604 ● WH/GR 9600 ● GR/WH
Ⓧ 5xGU10, ES111, max 75W



CROSS
stal lakierowana / painted steel / лакированная сталь
9603 ● WH/GR 9598 ● GR/WH
Ⓧ 1xGU10, ES111, max 75W

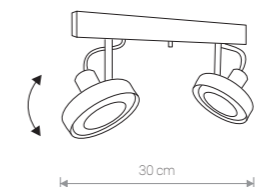

CROSS
stal lakierowana / painted steel / лакированная сталь
9602 ● WH/GR 9597 ● GR/WH
Ⓧ 2xGU10, ES111, max 75W

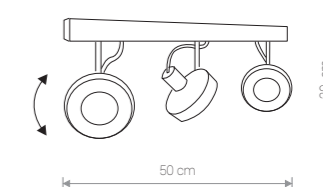

CROSS
stal lakierowana / painted steel / лакированная сталь
9601 ● WH/GR 9596 ● GR/WH
Ⓧ 3xGU10, ES111, max 75W



CUBOID 8806 BL



CUBOID 6523 WH



VESPA 9593 WH



VESPA 8838 BL



CUBOID 6590 WH



VESPA 9592 WH

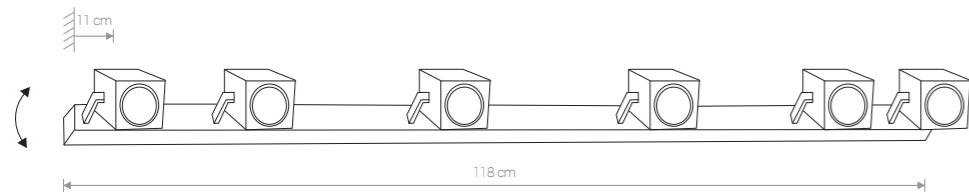

CUBOID

aluminium lakierowane / painted aluminum /
окрашенного алюминия

6524 ○ WH 8810 ● BL

Ⓧ 6×GU10, max 35W

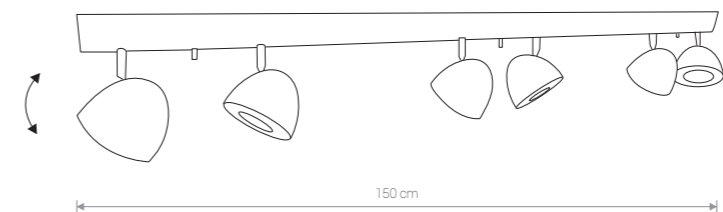

VESPA

stal lakierowana / painted steel / лакированная сталь

9595 ○ WH 8842 ● BL

Ⓧ 6×GU10, ES111, max 75W

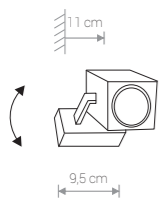

CUBOID

aluminium lakierowane / painted aluminum /
окрашенного алюминия

6522 ○ WH 8806 ● BL

Ⓧ 1×GU10, max 35W

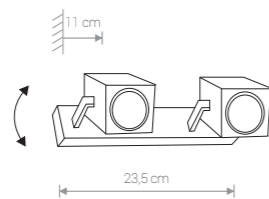

CUBOID

aluminium lakierowane / painted aluminum /
окрашенного алюминия

6523 ○ WH 8807 ● BL

Ⓧ 2×GU10, max 35W

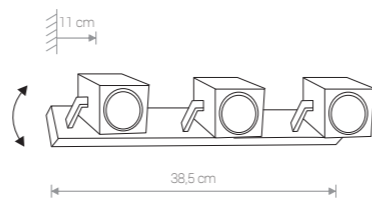

CUBOID

aluminium lakierowane / painted aluminum /
окрашенного алюминия

6590 ○ WH 8808 ● BL

Ⓧ 3×GU10, max 35W

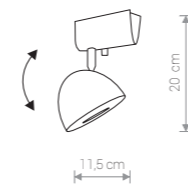

VESPA

stal lakierowana / painted steel / лакированная сталь

9594 ○ WH 8838 ● BL

Ⓧ 1×GU10, ES111, max 75W

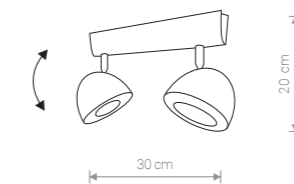

VESPA

stal lakierowana / painted steel / лакированная сталь

9593 ○ WH 8840 ● BL

Ⓧ 2×GU10, ES111, max 75W

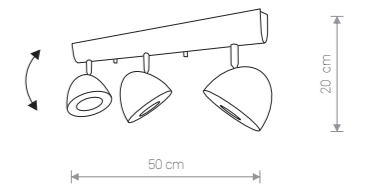

VESPA

stal lakierowana / painted steel / лакированная сталь

9592 ○ WH 8841 ● BL

Ⓧ 3×GU10, ES111, max 75W



EYE SPOT 6014 WH

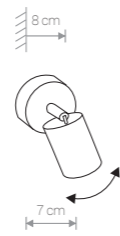

EYE SPOT

stal lakierowana, chrom / painted steel, chrome /
лакирована сталь, хром

6014 ○ WH 6138 ○ SI
6134 ● GR 6018 ● BL

Ⓛ 1×GU10, max 35W

stal lakierowana, stal mosiądzowana, mosiądz /
painted steel, electroplated brass, brass /
лакирована сталь, латунная сталь, латунь

8816 ● BL/BS

Ⓛ 1×GU10, max 35W

EYE SPOT 6611 BL



EYE SPOT

stal lakierowana, chrom / painted steel, chrome /
лакирована сталь, хром

6607 ○ WH 6608 ○ SI
6610 ● GR 6611 ● BL

Ⓛ 6×GU10, max 35W

stal lakierowana, stal mosiądzowana, mosiądz /
painted steel, electroplated brass, brass /
лакирована сталь, латунная сталь, латунь

8819 ● BL/BS

Ⓛ 6×GU10, max 35W



EYE SPOT 6140 SI

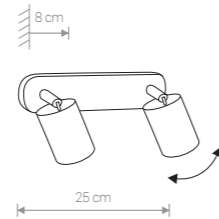

EYE SPOT

stal lakierowana, chrom / painted steel, chrome /
лакирована сталь, хром

6015 ○ WH 6140 ○ SI
6135 ● GR 6020 ● BL

Ⓛ 2×GU10, max 35W

stal lakierowana, stal mosiądzowana, mosiądz /
painted steel, electroplated brass, brass /
лакирована сталь, латунная сталь, латунь

8817 ● BL/BS

Ⓛ 2×GU10, max 35W



EYE SPOT 6136 GR

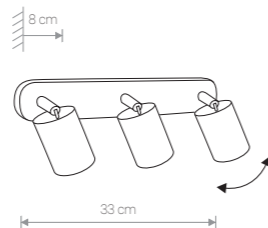

EYE SPOT

stal lakierowana, chrom / painted steel, chrome /
лакирована сталь, хром

6016 ○ WH 6141 ○ SI
6136 ● GR 6021 ● BL

Ⓛ 3×GU10, max 35W

stal lakierowana, stal mosiądzowana, mosiądz /
painted steel, electroplated brass, brass /
лакирована сталь, латунная сталь, латунь

8818 ● BL/BS

Ⓛ 3×GU10, max 35W



EYE SPOT 8820 BL/BS

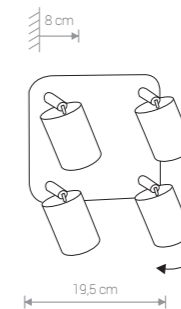

EYE SPOT

stal lakierowana, chrom / painted steel, chrome /
лакирована сталь, хром

6017 ○ WH 5844 ○ SI
6137 ● GR 6022 ● BL

Ⓛ 4×GU10, max 35W

stal lakierowana, stal mosiądzowana, mosiądz /
painted steel, electroplated brass, brass /
лакирована сталь, латунная сталь, латунь

8820 ● BL/BS

Ⓛ 4×GU10, max 35W



EYE FIT 9397 BL



EYE FIT 9400 BL



EYE FIT 9395 WH

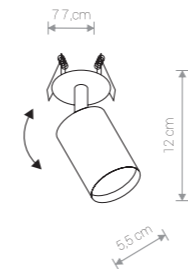

EYE FIT

stal lakierowana / painted steel /
лакированная сталь

9396 ○ WH 9400 ● BL

Ⓛ 1×GU10, max 35W

Ⓜ cut out ø 55 mm

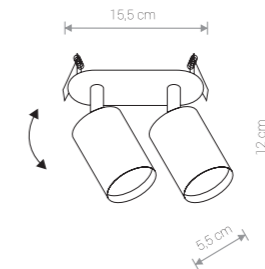

EYE FIT

stal lakierowana / painted steel /
лакированная сталь

9395 ○ WH 9398 ● BL

Ⓛ 2×GU10, max 35W

Ⓜ cut out 130×30 mm

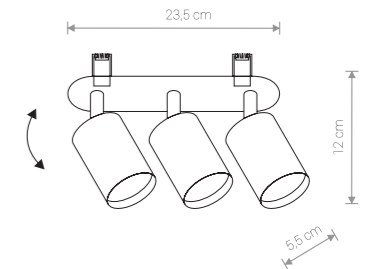

EYE FIT

stal lakierowana / painted steel /
лакированная сталь

9394 ○ WH 9397 ● BL

Ⓛ 3×GU10, max 35W

Ⓜ cut out 210×30 mm



COLVILLE 5726 WH



COLVILLE 5735 SI



COLVILLE 5727 WH



COLVILLE 8811 BL



COLVILLE 5737 SI

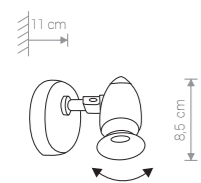

COLVILLE

stal lakierowana, PA / painted steel, PA / лакирована сталь, PA

5725 ○ WH 5732 ○ SI 8811 ● BL

Ⓛ 1×GU10, max 15W

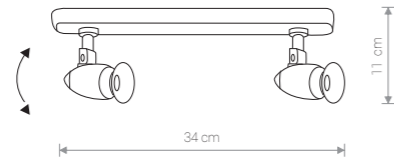

COLVILLE

stal lakierowana, PA / painted steel, PA / лакирована сталь, PA

5726 ○ WH 5733 ○ SI 8812 ● BL

Ⓛ 2×GU10, max 15W

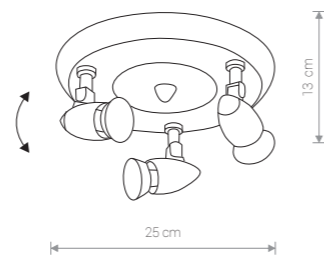

COLVILLE

stal lakierowana, PA / painted steel, PA / лакирована сталь, PA

5727 ○ WH 5734 ○ SI 8814 ● BL

Ⓛ 3×GU10, max 15W

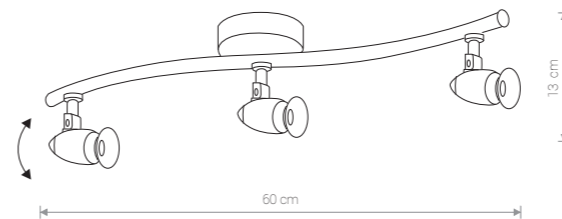

COLVILLE

stal lakierowana, PA / painted steel, PA / лакирована сталь, PA

5728 ○ WH 5735 ○ SI 8813 ● BL

Ⓛ 3×GU10, max 15W

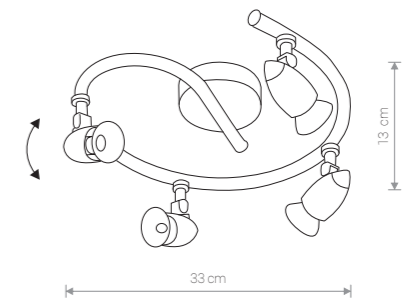

COLVILLE

stal lakierowana, PA / painted steel, PA / лакирована сталь, PA

5731 ○ WH 5737 ○ SI 8815 ● BL

Ⓛ 4×GU10, max 15W



IRIS LED 8993 WH



SHOP LED 5945 WH



IRIS LED 8994 BL

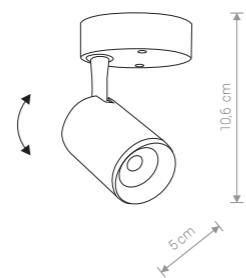

IRIS LED 7W

aluminium, plastik / aluminium, plastic / алюминий, пластики

8993 ○ WH 8994 ● BL

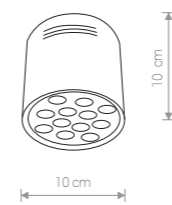

SHOP LED 12W

stal lakierowana / painted steel / лакирована сталь

5946 ○ WH

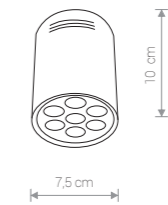

SHOP LED 7W

stal lakierowana / painted steel / лакирована сталь

5945 ○ WH

Item No.	POWER	COLOUR TEMP	LUMINOUS FLUX	BEAM ANGLE	COLOUR RENDERING INDEX (CRI →)	INPUT	SAFETY TYPE	POWER FACTOR	INGRESS PROTECTION	LIFETIME
8993, 8994	7x1W LED	3000K	420 lm	30°	80	~200-240V, 50Hz	☐	> 0,5	IP 20	30 000 h
5945	7x1W LED	4000K	630 - 700 lm	30°	80	~200-240V, 50Hz	☐	> 0,5	IP 20	8 000 h
5946	12x1W LED	4000K	1080-1200 lm	30°	80	~200-240V, 50Hz	☐	> 0,5	IP 20	8 000 h

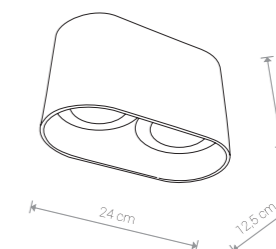
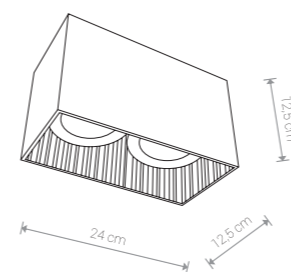
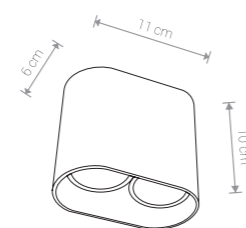
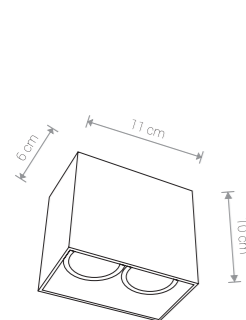

GAP

aluminium lakierowane / painted aluminium / лакированное алюминий

9385 ○ WH 9384 ● BL

Ⓛ 2×GU10, max 35W

PAG

aluminium lakierowane / painted aluminium / лакированное алюминий

9387 ○ WH 9386 ● BL

Ⓛ 2×GU10, max 35W

GROOVE

aluminium lakierowane / painted aluminium / лакированное алюминий

9383 ○ WH 9316 ● BL

Ⓛ 2×GU10, ES111, max 75W

OVAL

aluminium lakierowane / painted aluminium / лакированное алюминий

9241 ○ WH 9240 ● BL

Ⓛ 2×GU10, ES111, max 75W

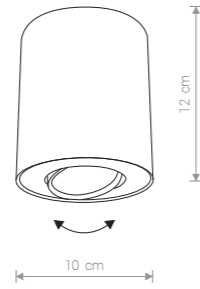

SET

stal lakierowana, PA / painted steel, PA /
лакированная сталь, PA

8900 ● BL 8895 ○ WH

1×GU10, 10W, only LED

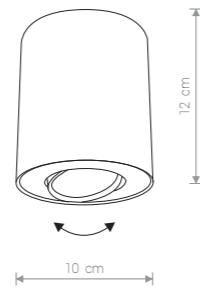

SET

stal lakierowana, PA / painted steel, PA /
лакированная сталь, PA

8902 ● BL/SI 8897 ○ WH/SI

1×GU10, 10W, only LED

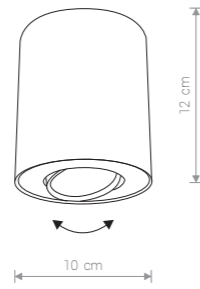

SET

stal lakierowana, PA / painted steel, PA /
лакированная сталь, PA

8901 ● BL/G 8896 ○ WH/G

1×GU10, 10W, only LED

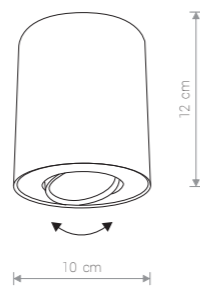

SET

stal lakierowana, PA / painted steel, PA /
лакированная сталь, PA

8903 ● BL/WH 8898 ● WH/BL

1×GU10, 10W, only LED

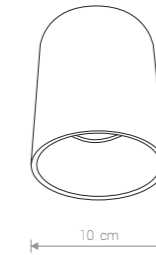

EYE TONE

stal lakierowana, ABS / painted steel, ABS /
лакированная сталь, ABS

8932 ● BL/SI 8928 ○ WH/SI

1×GU10, 10W, only LED

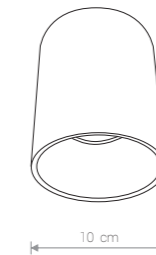

EYE TONE

stal lakierowana, ABS / painted steel, ABS /
лакированная сталь, ABS

8931 ● BL/G 8926 ○ WH/G

1×GU10, 10W, only LED

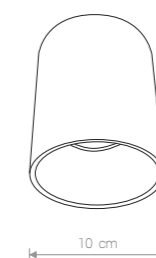

EYE TONE

stal lakierowana, ABS / painted steel, ABS /
лакированная сталь, ABS

8930 ● BL 8925 ○ WH

1×GU10, 10W, only LED



DOWNLIGHT M 4866 WH

DOWNLIGHT S 4867 SI

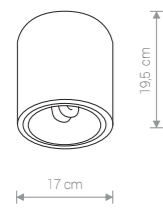

DOWNLIGHT M

stal lakierowana, aluminium / painted steel, aluminium / лакирована сталь, алюминий

4866 ○ WH

Ⓛ 1×E27, max 30W

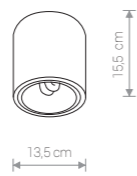

DOWNLIGHT S

stal lakierowana, aluminium / painted steel, aluminium / лакирована сталь, алюминий

4865 ○ WH 4867 ○ SI

Ⓛ 1×E27, max 25W



BIT M 9481 WH



BIT S 9486 GR



BIT S 9484 SI

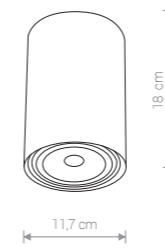

BIT M

stal lakierowana / painted steel / лакирована сталь

9481 ○ WH 9483 ○ SI 9485 ● GR

Ⓛ 1×GU10, ES111, max 75W

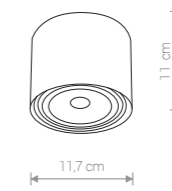

BIT S

stal lakierowana / painted steel / лакирована сталь

9482 ○ WH 9484 ○ SI 9486 ● GR

Ⓛ 1×GU10, ES111, max 75W



POINT PLEXI L 6531 SI



POINT PLEXI L 6528 WH



POINT PLEXI M 6526 BL

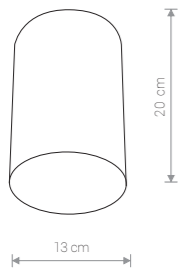

POINT PLEXI L

stal lakierowana, PMMA / painted steel, PMMA / лакирована сталь, PMMA

6528 ○ WH 6531 ● SI 6530 ● BL

1×E27 max 20W

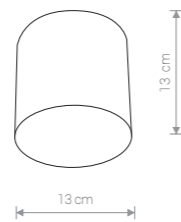

POINT PLEXI M

stal lakierowana, PMMA / painted steel, PMMA / лакирована сталь, PMMA

6525 ○ WH 6527 ● SI 6526 ● BL

1×GU10, max 10W



POINT S 6003 SI/GR

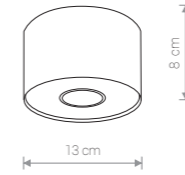

POINT S

stal lakierowana / painted steel / лакирована сталь

6003 ● SI/GR

1×GU10, max 35W



POINT M 6001 WH

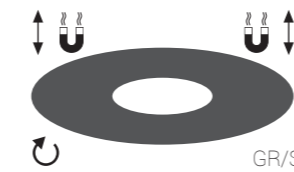

POINT S

stal lakierowana / painted steel / лакирована сталь

6000 ○ WH

1×GU10, max 35W

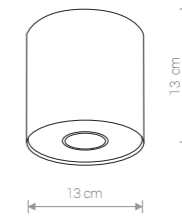

POINT M

stal lakierowana / painted steel / лакирована сталь

6001 ○ WH

1×GU10, max 35W

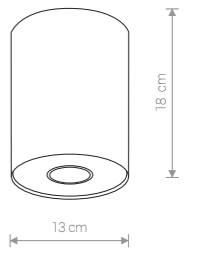

POINT L

stal lakierowana / painted steel / лакирована сталь

6002 ○ WH

1×GU10, max 35W



POINT L 6008 GR

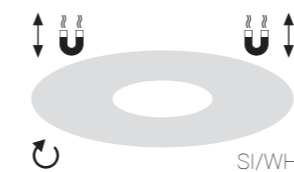

POINT S

stal lakierowana / painted steel / лакирована сталь

6006 ● GR

1×GU10, max 35W

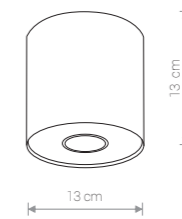

POINT M

stal lakierowana / painted steel / лакирована сталь

6007 ● GR

1×GU10, max 35W

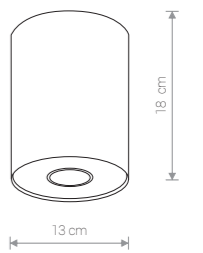

POINT L

stal lakierowana / painted steel / лакирована сталь

6008 ● GR

1×GU10, max 35W



BOX LED 6427 BL



BOX LED 6422 WH

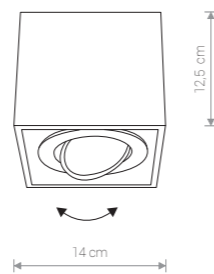

BOX LED

sklejka, stal lakierowana, stal chromowana /
plywood, painted steel, electropolated steel /
дерево, лакированная сталь, хромированная сталь

6422 ○ WH 6427 ● BL

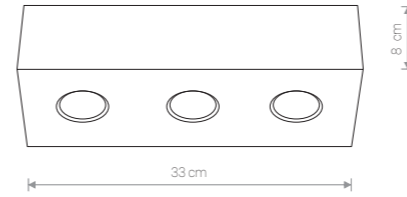

CARSON

stal lakierowana / painted steel / лакирована сталь

5575 ○ WH/SI

💡 3×GU10, max 50W



CARSON 5575 WH/SI

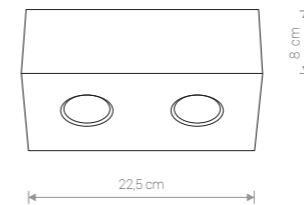

CARSON

stal lakierowana / painted steel / лакирована сталь

5574 ○ WH/SI 5570 ● BL/SI

💡 2×GU10, max 50W



CARSON 5570 BL/SI

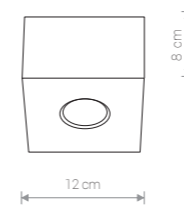

CARSON

stal lakierowana / painted steel / лакирована сталь

5573 ○ WH/SI 5568 ● BL/SI

💡 1×GU10, max 50W



CARSON 5573 WH/SI

Item No.	POWER	COLOUR TEMP.	LUMINOUS FLUX	BEAM ANGLE	COLOUR RENDERING INDEX (CRI >)	INPUT	SAFETY TYPE	POWER FACTOR	INGRESS PROTECTION
6422, 6427	7x1W LED	4000K	700 - 770 lm	30°	80	~200-240V, 50Hz	□	> 0,5	IP 20



DOWNLIGHT ES111 9575 WH



DOWNLIGHT ES111 9573 SI



DOWNLIGHT ES111 9571 BL

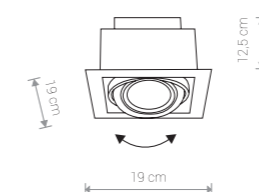

DOWNLIGHT ES111

stal lakierowana / painted steel / лакированная сталь

9571 ● BL 9573 ● SI 9575 ○ WH

1×GU10, ES111, max 75W

cut out 165 × 165 mm

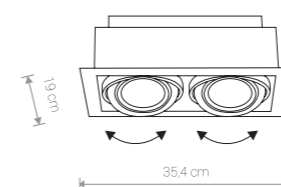

DOWNLIGHT ES111

stal lakierowana / painted steel / лакированная сталь

9570 ● BL 9572 ● SI 9574 ○ WH

2×GU10, ES111, max 75W

cut out 320 × 165 mm



BOX ES111 9497 WH



BOX ES111 9496 GY



BOX ES111 9495 BL

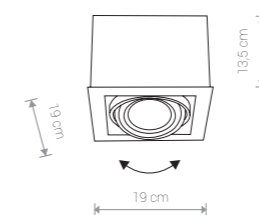

BOX ES111

sklejka, stal lakierowana / plywood, painted steel / дерево, лакированная сталь

9495 ● BL 9496 ● GY 9497 ○ WH

1×GU10, ES111, max 75W

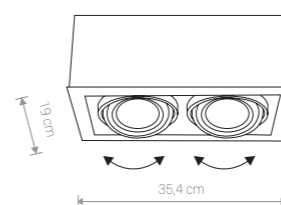

BOX ES111

sklejka, stal lakierowana / plywood, painted steel / дерево, лакированная сталь

9470 ● BL 9471 ● GY 9472 ○ WH

2×GU10, ES111, max 75W



MOD 9417 BL

MOD 9416 BL

MOD PLUS 9404 BL

MOD 9412 WH

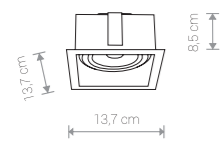

MOD

stal lakierowana / painted steel / лакированная сталь

9417 ● BL 9413 ○ WH

Ⓧ 1×GU10, ES111, max 75W

✂ cut out 120×120 mm

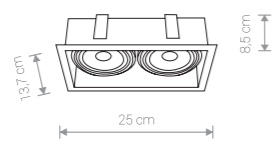

MOD

stal lakierowana / painted steel / лакированная сталь

9416 ● BL 9412 ○ WH

Ⓧ 2×GU10, ES111, max 75W

✂ cut out 120×230 mm

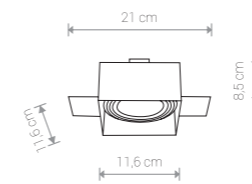

MOD PLUS

stal lakierowana / painted steel / лакированная сталь

9404 ● BL 9408 ○ WH

Ⓧ 1×GU10, ES111, max 75W

✂ cut out 120×120 mm

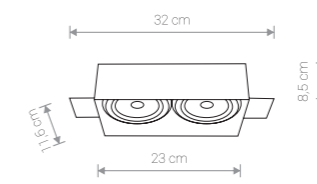

MOD PLUS

stal lakierowana / painted steel / лакированная сталь

9403 ● BL 9407 ○ WH

Ⓧ 2×GU10, ES111, max 75W

✂ cut out 120×230 mm

MOD PLUS 9404 BL





EYE MOD 8937 BL

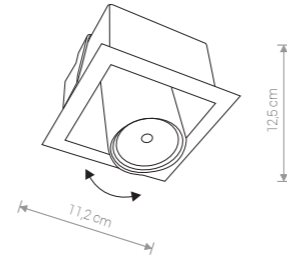

EYE MOD

stal lakierowana / painted steel / лакированная сталь

8936 ○ WH 8937 ● BL

1×GU10, max 35W

cut out ø 95×90 mm



EYE MOD 8938 WH

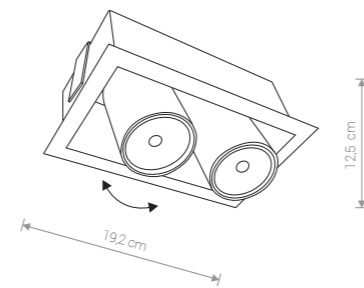

EYE MOD

stal lakierowana / painted steel / лакированная сталь

8938 ○ WH 8940 ● BL

2×GU10, max 35W

cut out ø 175×90 mm



DOT 9378 WH



DOT 9378 WH

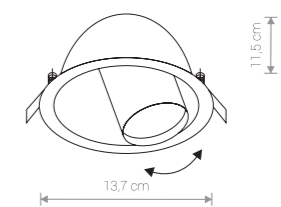

DOT

stal lakierowana / painted steel / лакированная сталь

9378 ○ WH 8826 ● BL

1×GU10, max 35W

cut out ø 125 mm

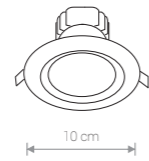

CEILING LED

stal lakierowana, szkło / painted steel, glass /
лакирована сталь, стекло

5954 ○ WH

cut out ø 70 mm

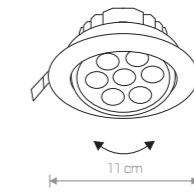

CEILING LED

stal lakierowana, plastik / electroplated steel, plastics /
хромированная сталь, пластики

5960 ○ WH

cut out ø 90 mm

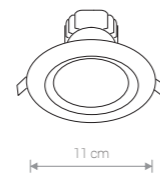

CEILING LED

stal lakierowana, szkło / painted steel, glass /
лакирована сталь, стекло

5955 ○ WH

cut out ø 75 mm

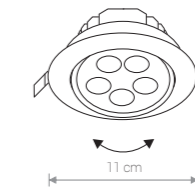

CEILING LED

stal lakierowana, plastik / electroplated steel, plastics /
хромированная сталь, пластики

5958 ○ WH

cut out ø 85 mm

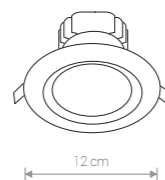

CEILING LED

stal lakierowana, szkło / painted steel, glass /
лакирована сталь, стекло

5956 ○ WH

cut out ø 85 mm

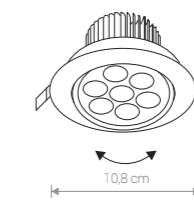

DOWNLIGHT LED

stal lakierowana, chromowana / painted, electroplated, steel /
лакирована, хромированная сталь

6823 ● SI

cut out ø 85 mm

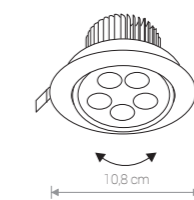

DOWNLIGHT LED

stal lakierowana, chromowana / painted, electroplated, steel /
лакирована, хромированная сталь

6822 ● SI

cut out ø 85 mm

Item No.	POWER	COLOUR TEMP.	LUMINOUS FLUX	BEAM ANGLE	COLOUR RENDERING INDEX (CRI >)	INPUT	SAFETY TYPE	INGRESS PROTECTION
5954	3W	4000K	270-300 lm	120°	80	~230V, 50Hz	□	IP 20
5955	5W	4000K	450-500 lm	120°	80	~230V, 50Hz	□	IP 20
5956	7W	4000K	630-700 lm	120°	80	~230V, 50Hz	□	IP 20

Item No.	POWER	COLOUR TEMP.	LUMINOUS FLUX	BEAM ANGLE	COLOUR RENDERING INDEX (CRI >)	INPUT	SAFETY TYPE	INGRESS PROTECTION
5960	7W	4000K	630-700 lm	30°	80	~230V, 50Hz	□	IP 20
5958	5W	4000K	450-500 lm	30°	80	~230V, 50Hz	□	IP 20
6822	5W	4000K	500-555 lm	30°	80	~230V, 50Hz	□	IP 20
6823	7W	4000K	700-770 lm	30°	80	~230V, 50Hz	□	IP 20



HELIOS 8992 WH



EOL 8988 WH



CEILING COB 6971 WH



CEILING COB 6972 WH

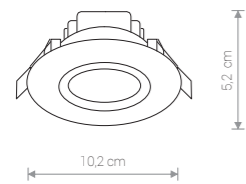

HELIOS

plastik, PC dyfuzor / plastic, PC diffuser /
пластик, РС диффузор

8991 ○ WH - 3000K

8992 ○ WH - 4000K

🔧 cut out ø 85 mm

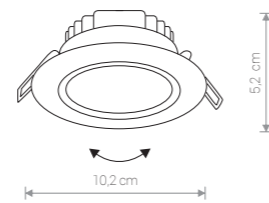

EOL

plastik, PC dyfuzor / plastic, PC diffuser /
пластик, РС диффузор

8988 ○ WH - 3000K

8990 ○ WH - 4000K

🔧 cut out ø 85 mm

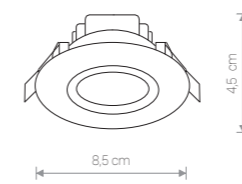

CEILING COB

plastik / plastics/ пластик

6971 ○ WH

🔧 cut out ø 70 mm

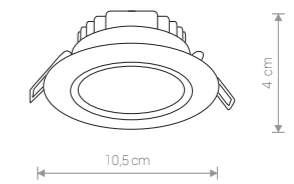

CEILING COB

plastik / plastics/ пластик

6972 ○ WH

🔧 cut out ø 90 mm

Item No.	POWER	COLOUR TEMP.	LUMINOUS FLUX	BEAM ANGLE	COLOUR RENDERING INDEX (CRI >=)	INPUT	SAFETY TYPE	POWER FACTOR	INGRESS PROTECTION	LIFETIME
8988	5W LED	3000K	265 lm	30°	80	~200-240V, 50Hz	☐	0,5	IP 44	20 000 h
8990	5W LED	4000K	265 lm	30°	80	~200-240V, 50Hz	☐	0,5	IP 44	20 000 h
8991	5W LED	3000K	260 lm	80°	80	~200-240V, 50Hz	☐	0,5	IP 44	20 000 h
8992	5W LED	4000K	260 lm	80°	80	~200-240V, 50Hz	☐	0,5	IP 44	20 000 h

Item No.	POWER	COLOUR TEMP.	LUMINOUS FLUX	BEAM ANGLE	COLOUR RENDERING INDEX (CRI >=)	INPUT	SAFETY TYPE	POWER FACTOR	INGRESS PROTECTION	LIFETIME
6971	5W	3000K	380 lm	60°	81	~230V, 50Hz	☐	0,55	IP 20	20 000 h
6972	10W	3000K	780 lm	60°	81	~230V, 50Hz	☐	0,55	IP 20	20 000 h



classic



PIREUS 4398 G



PIREUS 3380 G

20 cm



28 cm

PIREUS

znal, szkło / zamak, glass / алюминик, стекло

3375 ● G

1×E27, max 60W

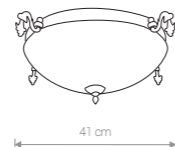

22 cm

41 cm

PIREUS

znal, szkło / zamak, glass / алюминик, стекло

4398 ● G

3×E27, max 60W

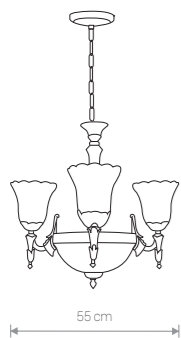

61 cm

150 cm

55 cm

PIREUS

znal, szkło / zamak, glass / алюминик, стекло

3376 ● G

6×E27, max 60W

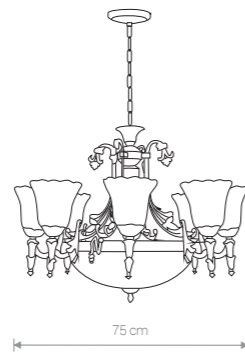

63 cm

162 cm

75 cm

PIREUS

znal, szkło / zamak, glass / алюминик, стекло

3380 ● G

11×E27, max 60W



АТТУКА 4397 G

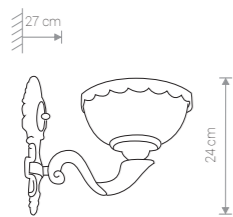

АТТУКА

znal, szkło / zamak, glass / алюминик, стекло

3361 G

1×E27, max 60W

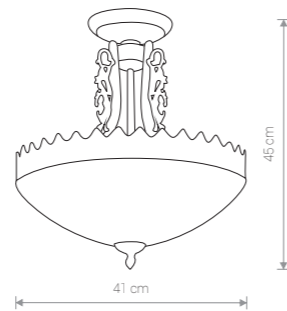

АТТУКА

znal, szkło / zamak, glass / алюминик, стекло

4397 G

3×E27, max 60W

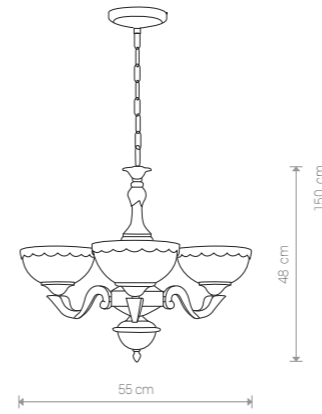

АТТУКА

znal, szkło / zamak, glass / алюминик, стекло

3362 G

3×E27, max 60W

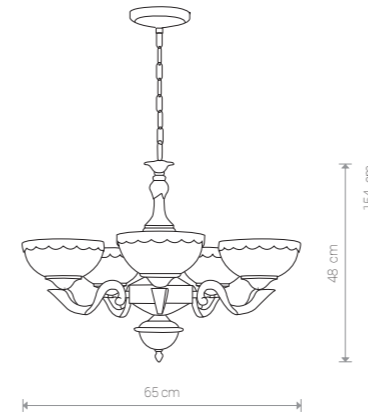

АТТУКА

znal, szkło / zamak, glass / алюминик, стекло

3363 G

5×E27, max 60W

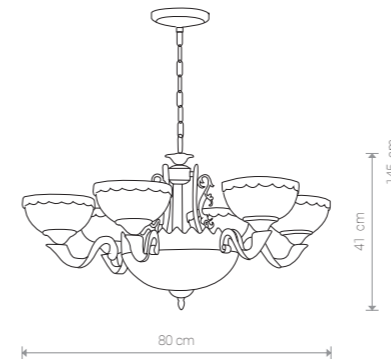

АТТУКА

znal, szkło / zamak, glass / алюминик, стекло

3364 G

9×E27, max 60W

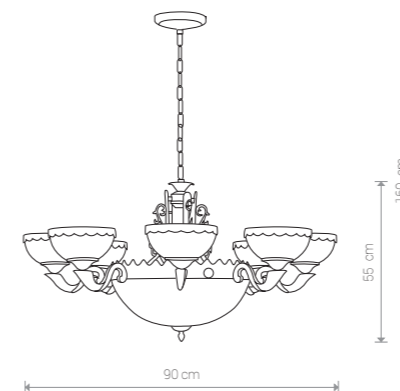

АТТУКА

znal, szkło / zamak, glass / алюминик, стекло

3365 G

11×E27, max 60W



АТТУКА 3363 G



АТТУКА 3365 G



KORYNT 3368 G

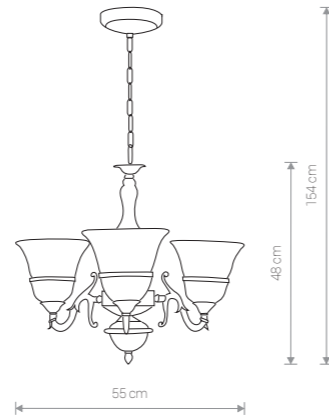

KORYNT

znal, szkto / zamak, glass / алюцинк, стекло

3368 ● G

3×E27, max 60W

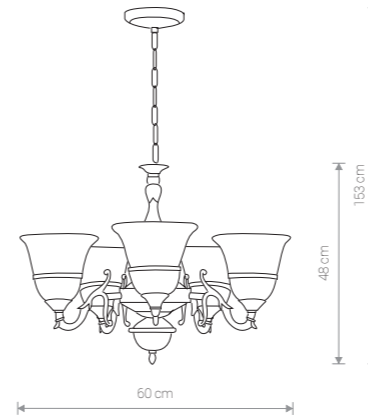

KORYNT

znal, szkto / zamak, glass / алюцинк, стекло

3370 ● G

5×E27, max 60W



KORYNT 3372 G

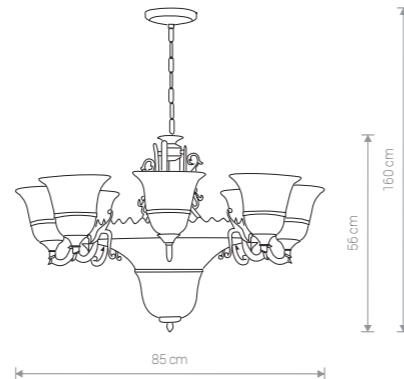

KORYNT

znal, szkto / zamak, glass / алюцинк, стекло

3372 ● G

11×E27, max 60W

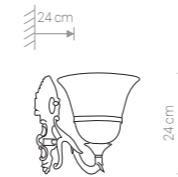

KORYNT

znal, szkto / zamak, glass / алюцинк, стекло

3367 ● G

1×E27, max 60W



KORYNT 3373 G

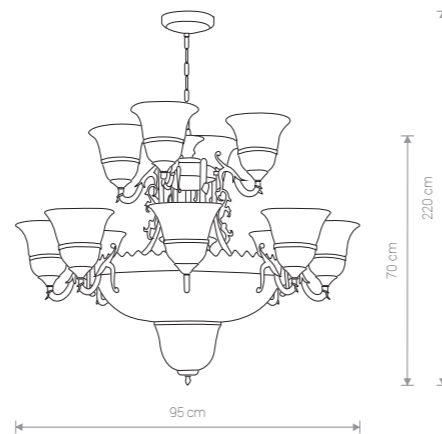

KORYNT

znal, szkto / zamak, glass / алюцинк, стекло

3373 ● G

15×E27, max 60W

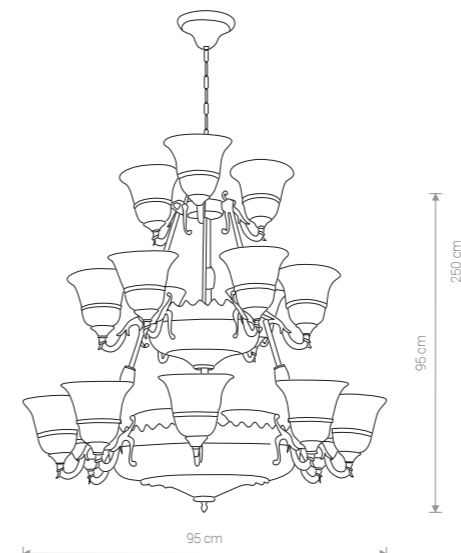

KORYNT

znal, szkto / zamak, glass / алюцинк, стекло

3374 ● G

24×E27, max 60W



KORYNT 3374 G



OLIMPIA 4354 EC/CO

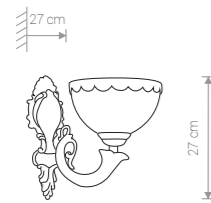

OLIMPIA

złaz, szkło / zamał, glass / алюцинł, стекло

4356 EC/CO

1x E27, max 60W

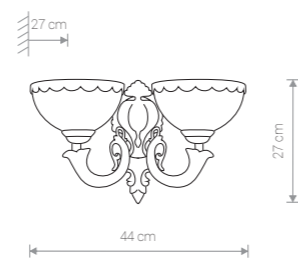

OLIMPIA

złaz, szkło / zamał, glass / алюцинł, стекло

4357 EC/CO

2x E27, max 60W

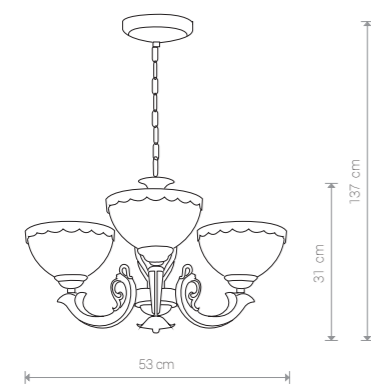

OLIMPIA

złaz, szkło / zamał, glass / алюцинł, стекло

4353 EC/CO

3x E27, max 60W

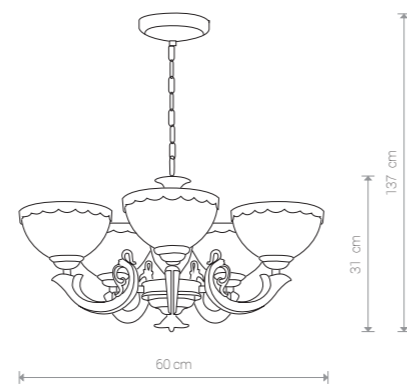

OLIMPIA

złaz, szkło / zamał, glass / алюцинł, стекло

4354 EC/CO

5x E27, max 60W



OLIMPIA 4355 EC/CO

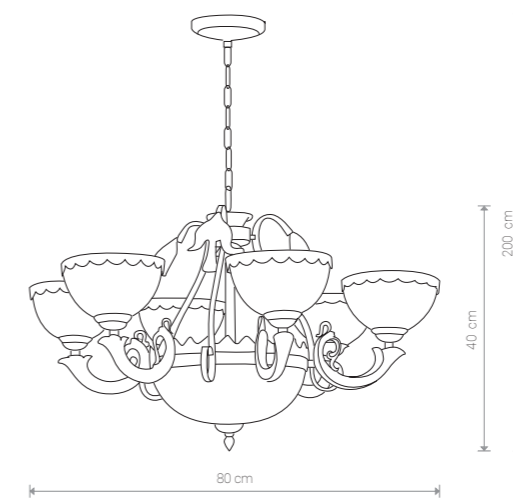

OLIMPIA

złaz, szkło / zamał, glass / алюцинł, стекло

4355 EC/CO

9x E27, max 60W



BARON 5997 WH/G



BARON 5994 WH/G



BARON 5995 WH/G

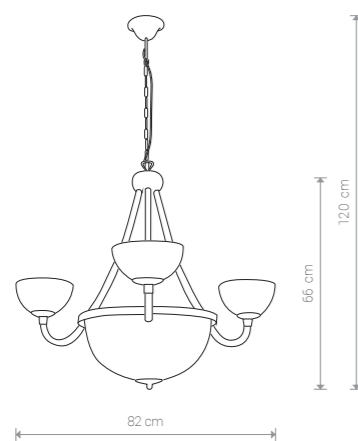

BARON

stal lakierowana, szkło / painted steel, glass / лакированная сталь, стекло

5996 WH/G 2771 BL/G

6x E27, max 60W

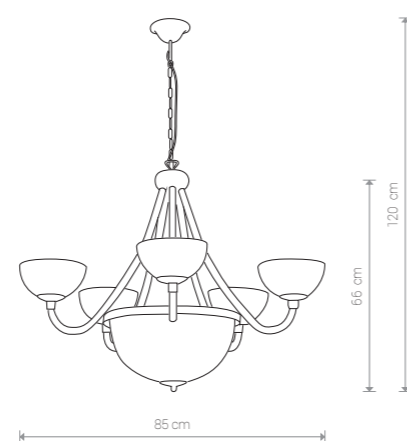

BARON

stal lakierowana, szkło / painted steel, glass / лакированная сталь, стекло

5997 WH/G 2772 BL/G

8x E27, max 60W

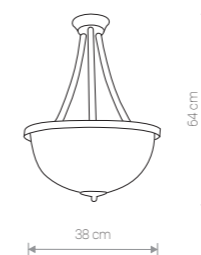

BARON

stal lakierowana, szkło / painted steel, glass / лакированная сталь, стекло

5994 WH/G 4140 BL/G

3x E27, max 60W

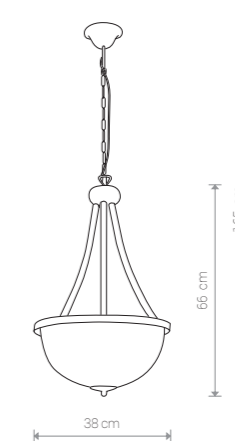

BARON

stal lakierowana, szkło / painted steel, glass / лакированная сталь, стекло

5995 WH/G 2770 BL/G

3x E27, max 60W



BARON 4997 BL/G

23 cm



28 cm

BARON

stal lakierowana, szkło / painted steel, glass /
лакированная сталь, стекло

5990 ● WH/G 2768 ● BL/G

1×E27, max 60W



38 cm

21 cm

BARON

stal lakierowana, szkło / painted steel, glass /
лакированная сталь, стекло

5991 ● WH/G 4996 ● BL/G

1×E27, max 60W

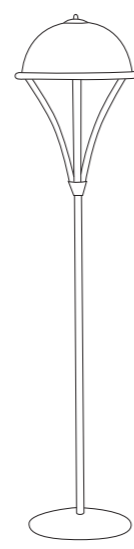

165 cm

38 cm

BARON

stal lakierowana, szkło / painted steel, glass /
лакированная сталь, стекло

5998 ● WH/G 4997 ● BL/G

3×E27, max 60W



BARON 4137 BL/G

BARON 4138 BL/G

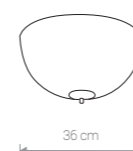

20 cm

36 cm

BARON

stal lakierowana, szkło / painted steel, glass /
лакированная сталь, стекло

4137 ● BL/G

2×E27, max 60W

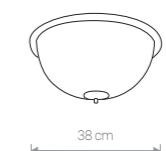

20 cm

38 cm

BARON

stal lakierowana, szkło / painted steel, glass /
лакированная сталь, стекло

5993 ● WH/G 4138 ● BL/G

2×E27, max 60W

MIKI 1512 BR

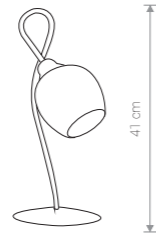

41 cm

MIKI

stal lakierowana, szkło / painted steel, glass /
лакированная сталь, стекло

1509 ● BR

1×E27, max 60W

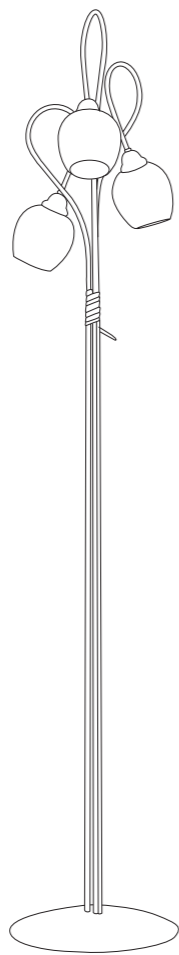

180 cm

35 cm

MIKI

stal lakierowana, szkło / painted steel, glass /
лакированная сталь, стекло

1512 ● BR

3×E27, max 60W



MIKI 1513 BR

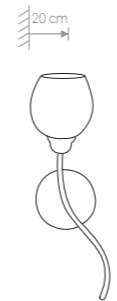

20 cm

47 cm

MIKI

stal lakierowana, szkło / painted steel, glass /
лакированная сталь, стекло

1845 ● BR

1×E27, max 60W

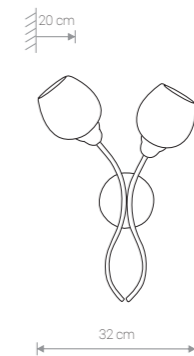

20 cm

47 cm

MIKI

stal lakierowana, szkło / painted steel, glass /
лакированная сталь, стекло

1510 ● BR

2×E27, max 60W

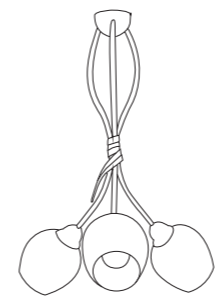

42 cm

55 cm

MIKI

stal lakierowana, szkło / painted steel, glass /
лакированная сталь, стекло

1511 ● BR

3×E27, max 60W

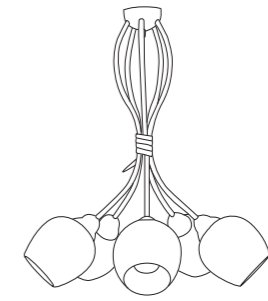

47 cm

55 cm

MIKI

stal lakierowana, szkło / painted steel, glass /
лакированная сталь, стекло

1513 ● BR

5×E27, max 60W



CORA 3486 WH/G



CORA 3485 WH/G

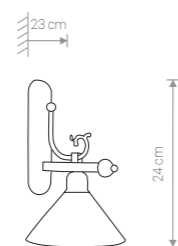

CORA

stal lakierowana, szkło / painted steel, glass /
лакированная сталь, стекло

3485 ● WH/G 3483 ● BR/G

Ⓛ 1×E27, max 60W



CORA 4745 BR/G

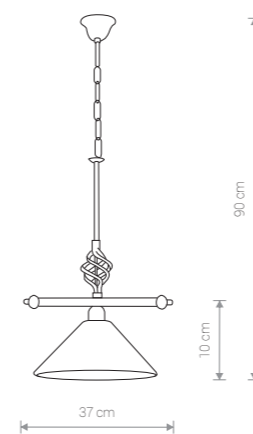

CORA

stal lakierowana, szkło / painted steel, glass /
лакированная сталь, стекло

4746 ● WH/G 4745 ● BR/G

Ⓛ 1×E27, max 60W

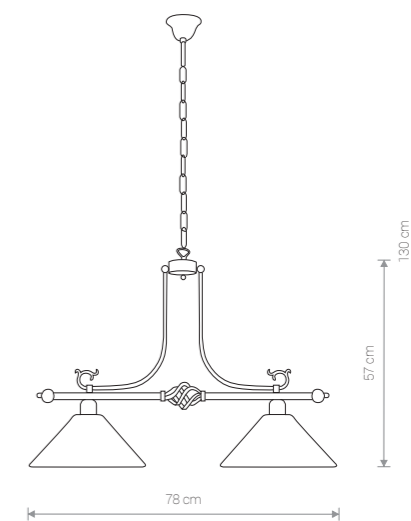

CORA

stal lakierowana, szkło / painted steel, glass /
лакированная сталь, стекло

3486 ● WH/G 3484 ● BR/G

Ⓛ 2×E27, max 60W



VIKTORIA 2998 G



VIKTORIA 2996 G

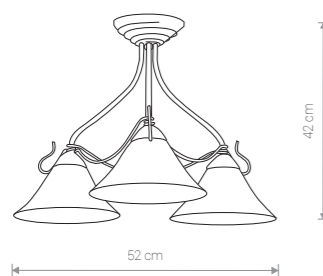

VIKTORIA

stal lakierowana, szkło / painted steel, glass /
лакированная сталь, стекло

2997 G

3×E27, max 60W

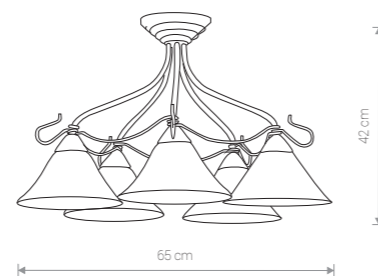

VIKTORIA

stal lakierowana, szkło / painted steel, glass /
лакированная сталь, стекло

2998 G

5×E27, max 60W

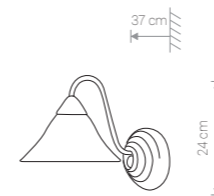

VIKTORIA

stal lakierowana, szkło / painted steel, glass /
лакированная сталь, стекло

2994 G

1×E27, max 60W



VIKTORIA

stal lakierowana, szkło / painted steel, glass /
лакированная сталь, стекло

2995 G

1×E27, max 60W

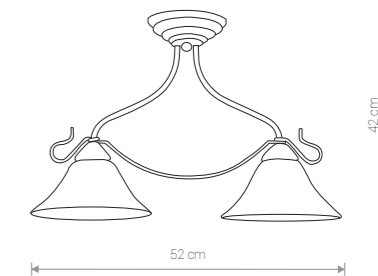

VIKTORIA

stal lakierowana, szkło / painted steel, glass /
лакированная сталь, стекло

2996 G

2×E27, max 60W



FLORES 3527 BL/SI

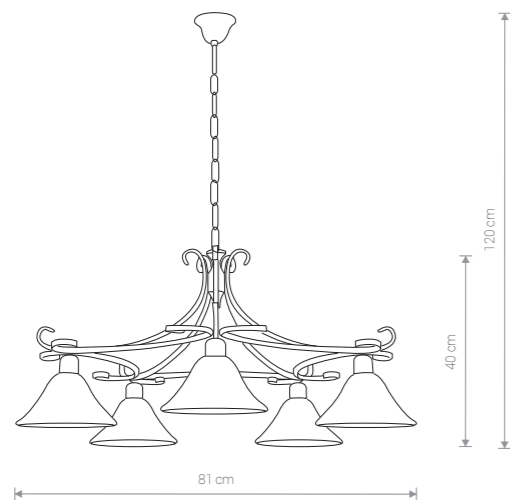

FLORES

stal lakierowana, szkło / painted steel, glass /
лакированная сталь, стекло

3527 ● BL/SI

Ⓛ 5×E27, max 60W



FLORES 3528 BL/SI

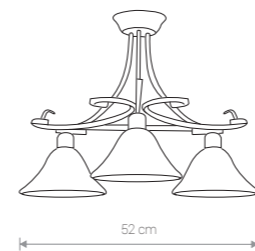

FLORES

stal lakierowana, szkło / painted steel, glass /
лакированная сталь, стекло

3526 ● BL/SI

Ⓛ 3×E27, max 60W

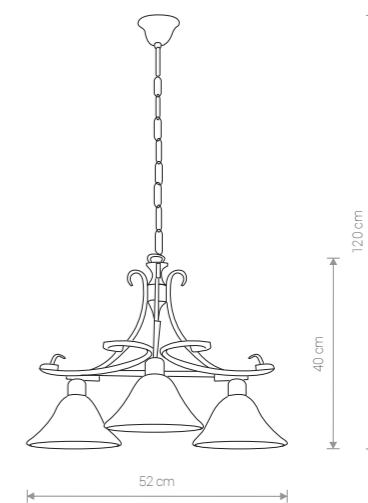

FLORES

stal lakierowana, szkło / painted steel, glass /
лакированная сталь, стекло

3525 ● BL/SI

Ⓛ 3×E27, max 60W

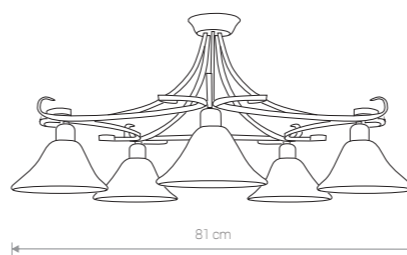

FLORES

stal lakierowana, szkło / painted steel, glass /
лакированная сталь, стекло

3528 ● BL/SI

Ⓛ 5×E27, max 60W

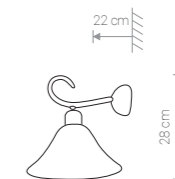

FLORES

stal lakierowana, szkło / painted steel, glass /
лакированная сталь, стекло

3524 ● BL/SI

Ⓛ 1×E27, max 60W



LIRA 401 BL/SI

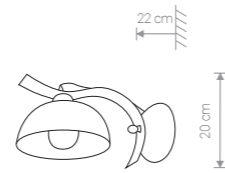

LIRA

stal lakierowana, szkło / painted steel, glass /
лакированная сталь, стекло

408 ● BL/SI

📍 1×E27, max 60W

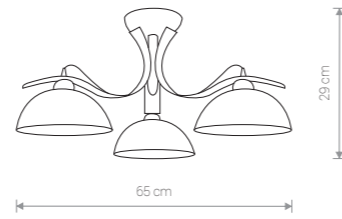

LIRA

stal lakierowana, szkło / painted steel, glass /
лакированная сталь, стекло

406 ● BL/SI

📍 3×E27, max 60W

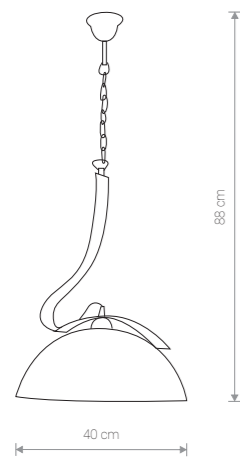

LIRA

stal lakierowana, szkło / painted steel, glass /
лакированная сталь, стекло

401 ● BL/SI

📍 1×E27, max 100W

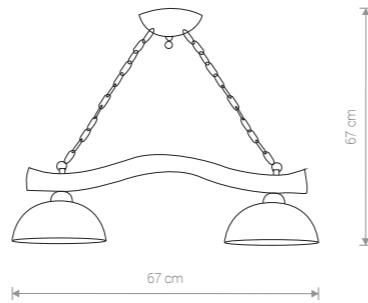

LIRA

stal lakierowana, szkło / painted steel, glass /
лакированная сталь, стекло

402 ● BL/SI

📍 2×E27, max 60W

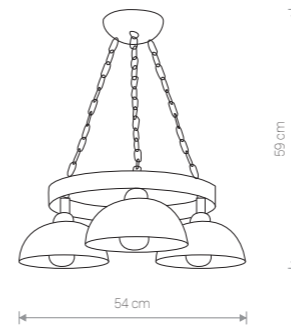

LIRA

stal lakierowana, szkło / painted steel, glass /
лакированная сталь, стекло

403 ● BL/SI

📍 3×E27, max 60W

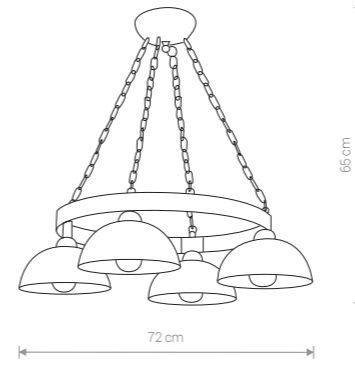

LIRA

stal lakierowana, szkło / painted steel, glass /
лакированная сталь, стекло

404 ● BL/SI

📍 4×E27, max 60W

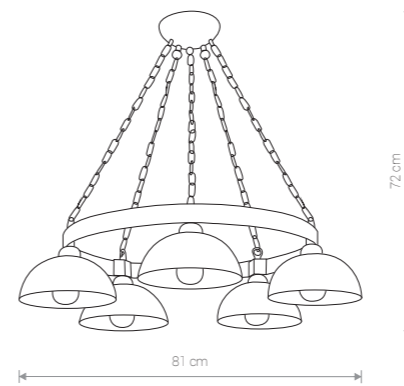

LIRA

stal lakierowana, szkło / painted steel, glass /
лакированная сталь, стекло

405 ● BL/SI

📍 5×E27, max 60W



LIRA 405 BL/SI

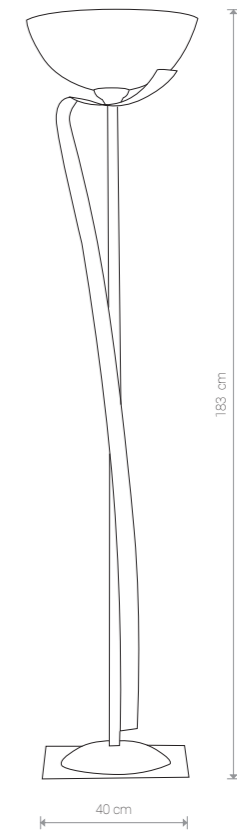

LIRA

stal lakierowana, szkło / painted steel, glass /
лакированная сталь, стекло

409 ● BL/SI

📍 1×E27, max 100W



MARGARET 6330 WH



TESA 1055 WH/G

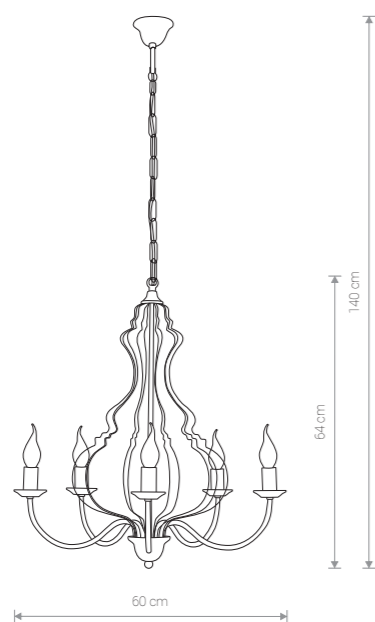

MARGARET

stal lakierowana / painted steel /
лакированная сталь

6330 ○ WH 6328 ● BL

Ⓧ 5×E14, max 60W

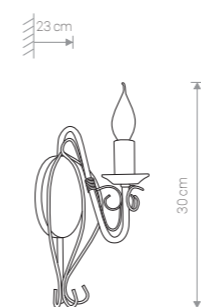

TESA

stal lakierowana / painted steel /
лакированная сталь

1051 ○ WH/G

Ⓧ 1×E14, max 60W

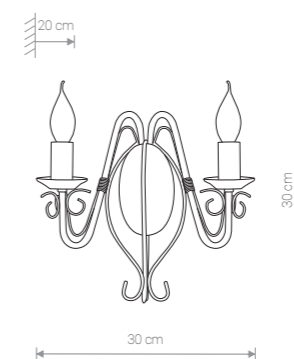

TESA

stal lakierowana / painted steel /
лакированная сталь

1052 ○ WH/G

Ⓧ 2×E14, max 60W

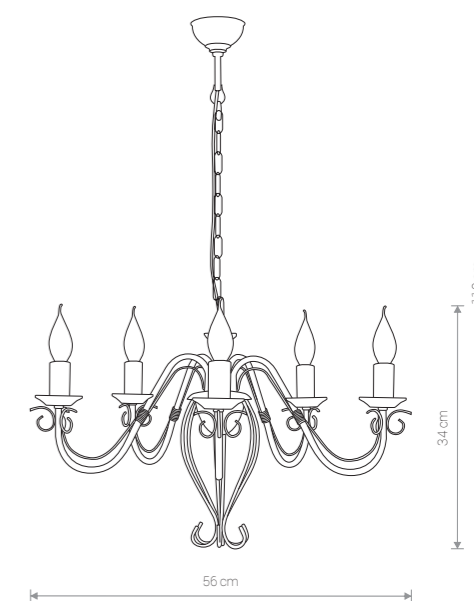

TESA

stal lakierowana / painted steel /
лакированная сталь

1055 ○ WH/G

Ⓧ 5×E14, max 60W



FRESCO 4561 EC/G

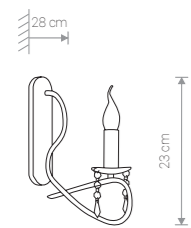

FRESCO

stal lakierowana, kryształki / painted steel, crystals /
лакированная сталь, кристаллики

4558 ● EC/G

Ⓛ 1×E14, max 60W

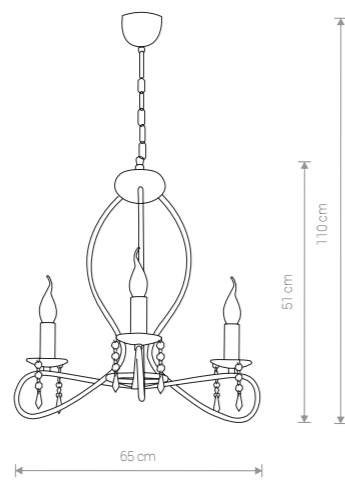

FRESCO

stal lakierowana, kryształki / painted steel, crystals /
лакированная сталь, кристаллики

4561 ● EC/G

Ⓛ 3×E14, max 60W

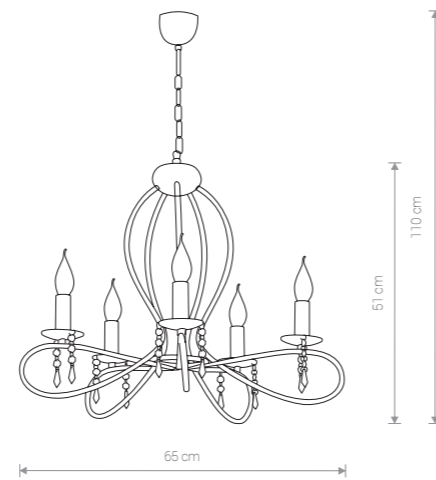

FRESCO

stal lakierowana, kryształki / painted steel, crystals /
лакированная сталь, кристаллики

4562 ● EC/G

Ⓛ 5×E14, max 60W



FRESCO 4563 EC/G

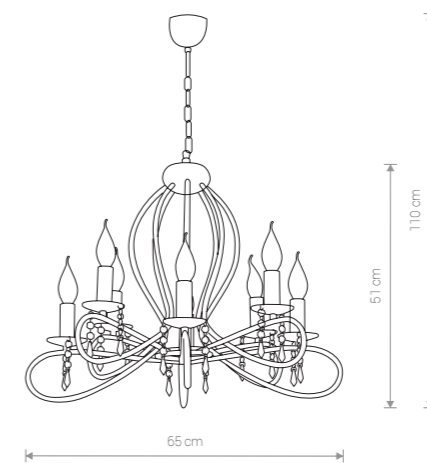

FRESCO

stal lakierowana, kryształki / painted steel, crystals /
лакированная сталь, кристаллики

4563 ● EC/G

Ⓛ 8×E14, max 60W



SILVERADO 5417 SI

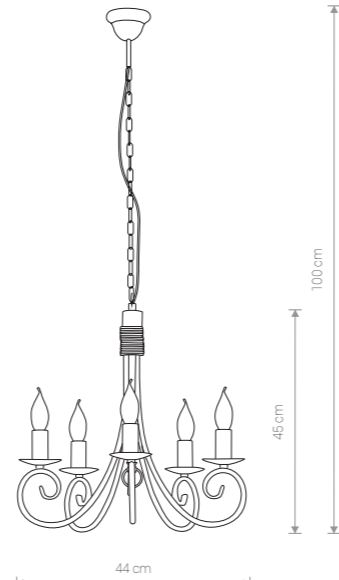

SILVERADO

stal lakierowana / painted steel /
лакированная сталь

5417 ● SI

Ⓧ 5×E14, max 60W

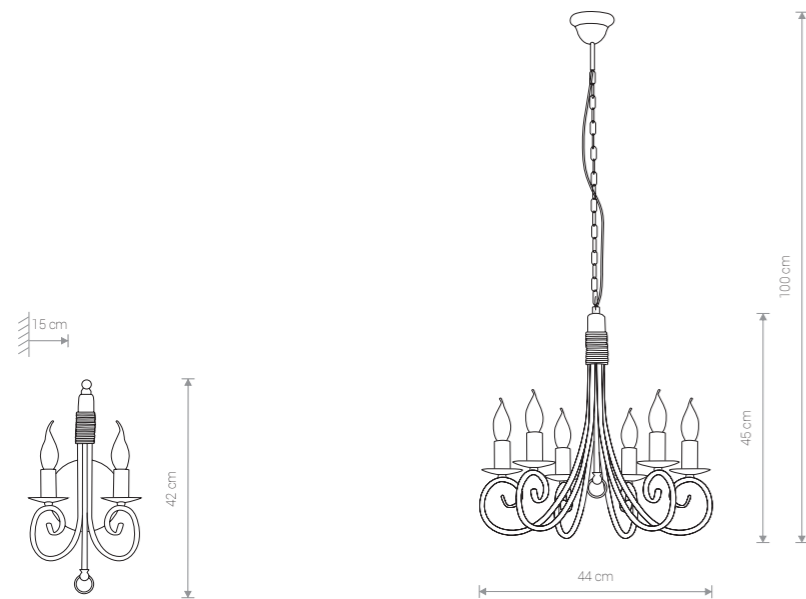

SILVERADO

stal lakierowana / painted steel /
лакированная сталь

5415 ● SI

Ⓧ 2×E14, max 60W

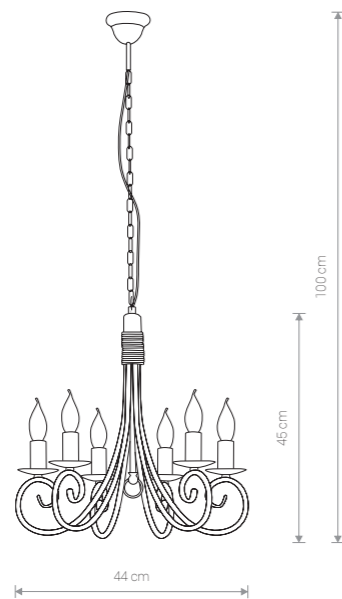

SILVERADO

stal lakierowana / painted steel /
лакированная сталь

5418 ● SI

Ⓧ 6×E14, max 60W

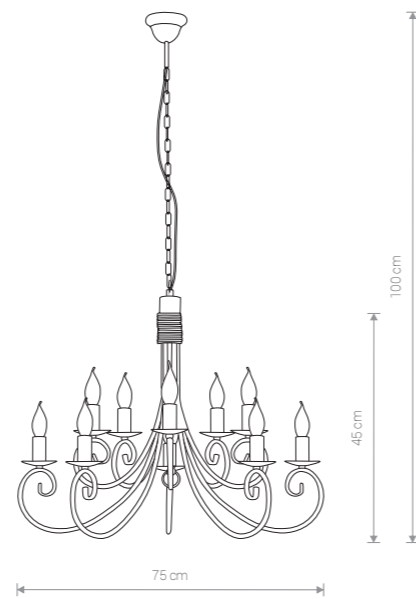

SILVERADO

stal lakierowana / painted steel /
лакированная сталь

5420 ● SI

Ⓧ 10×E14, max 60W

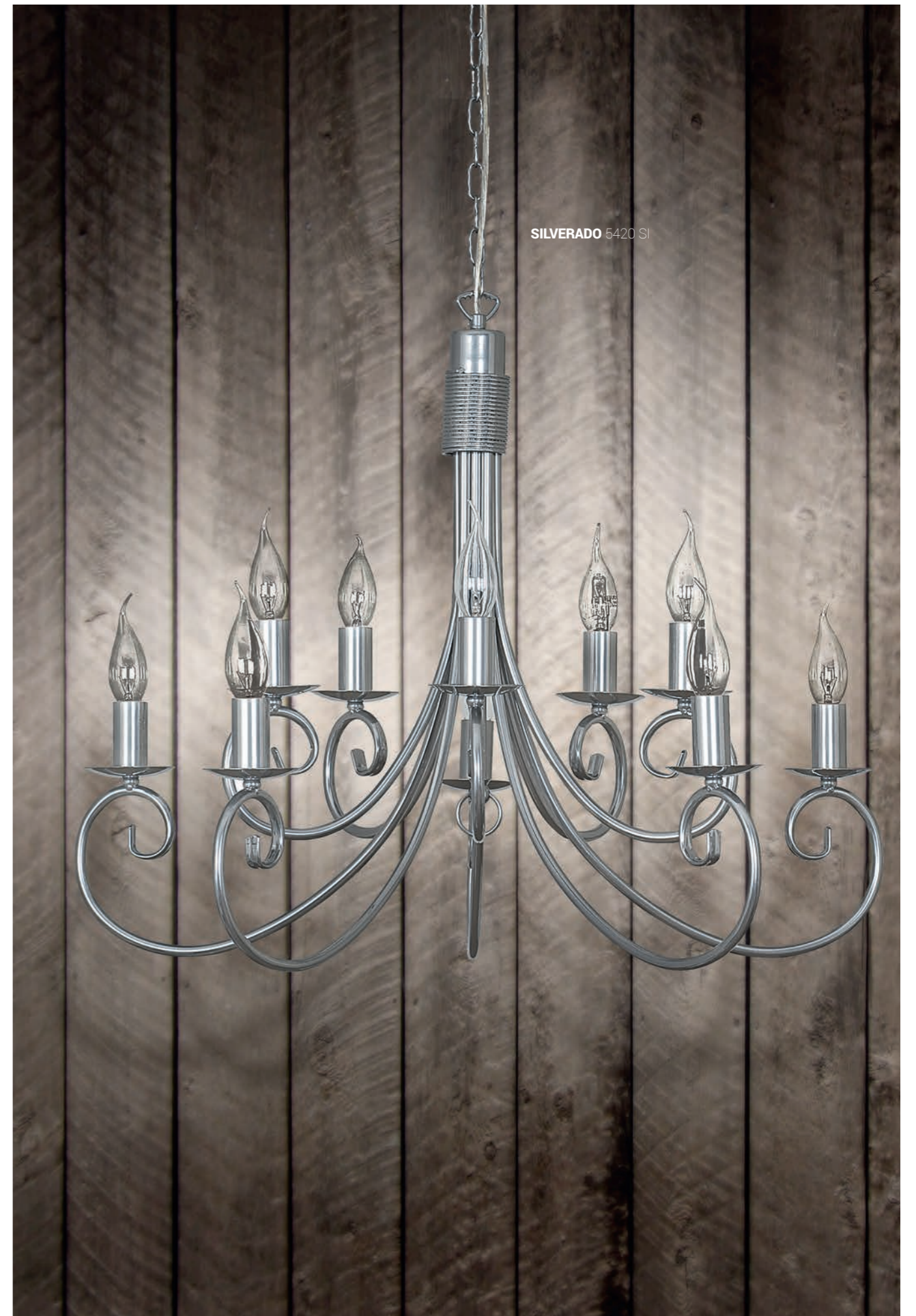

SILVERADO 5420 SI



TWIST 4985 WH/G

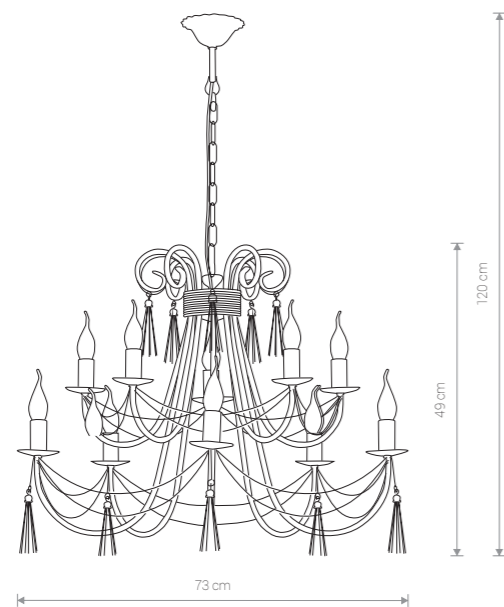

TWIST

stal lakierowana / painted steel / лакированная сталь

4985 WH/G 2767 BR/G

10xE14, max 60W

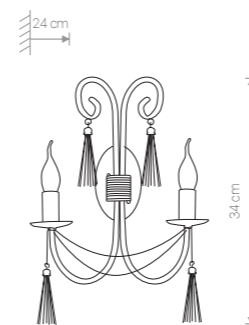

TWIST

stal lakierowana / painted steel / лакированная сталь

4981 WH/G 2763 BR/G

2xE14, max 60W

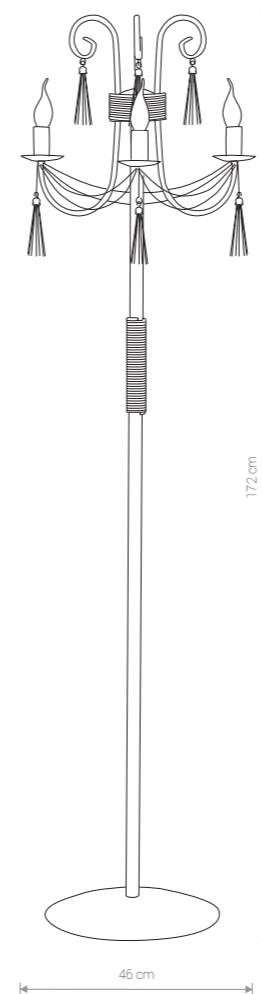

TWIST

stal lakierowana / painted steel / лакированная сталь

4982 WH/G 2765 BR/G

3xE14, max 60W

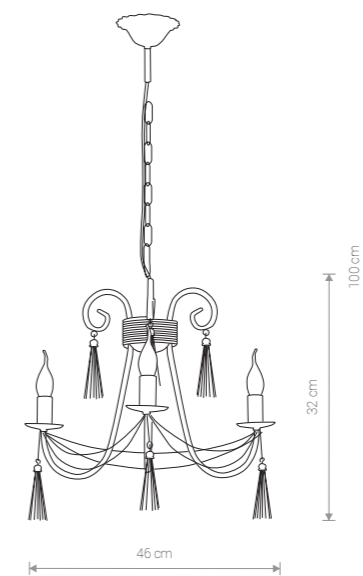

TWIST

stal lakierowana / painted steel / лакированная сталь

4983 WH/G 2764 BR/G

3xE14, max 60W



TWIST 2763 BR/G

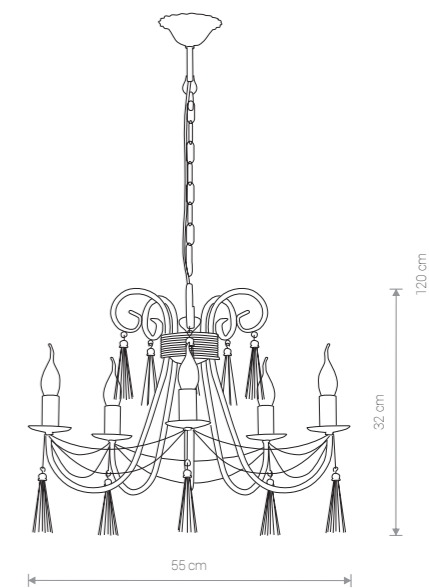

TWIST

stal lakierowana / painted steel / лакированная сталь

4984 WH/G 2766 BR/G

5xE14, max 60W



PŁOMYK 483 BL/CO



PŁOMYK 493 BL/CO

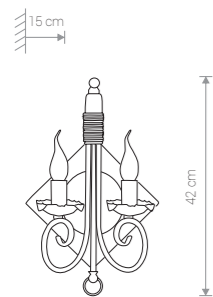

PŁOMYK

stal lakierowana / painted steel / лакированная сталь

485 ● BL/CO

Ⓢ 2×E14, max 60W

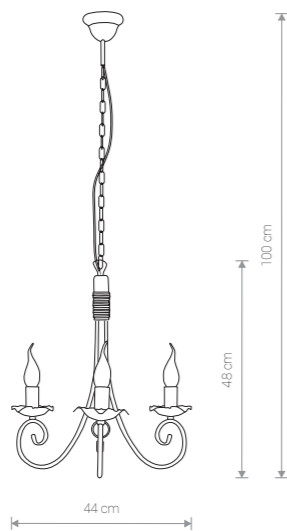

PŁOMYK

stal lakierowana / painted steel / лакированная сталь

481 ● BL/CO

Ⓢ 3×E14, max 60W

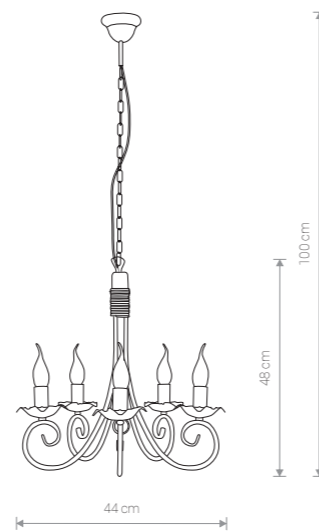

PŁOMYK

stal lakierowana / painted steel / лакированная сталь

483 ● BL/CO

Ⓢ 5×E14, max 60W

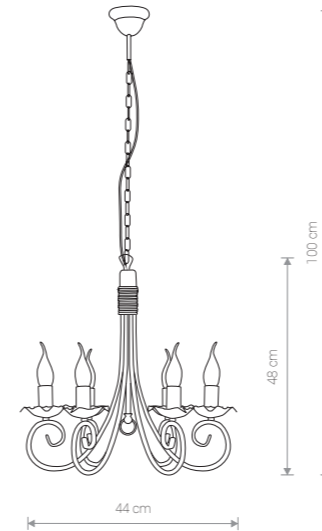

PŁOMYK

stal lakierowana / painted steel / лакированная сталь

484 ● BL/CO

Ⓢ 6×E14, max 60W

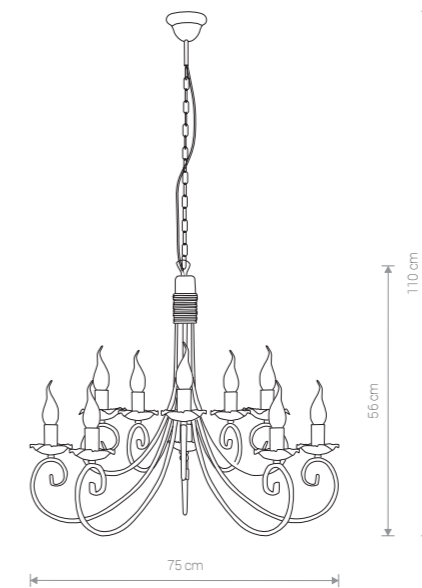

PŁOMYK

stal lakierowana / painted steel / лакированная сталь

491 ● BL/CO

Ⓢ 10×E14, max 60W

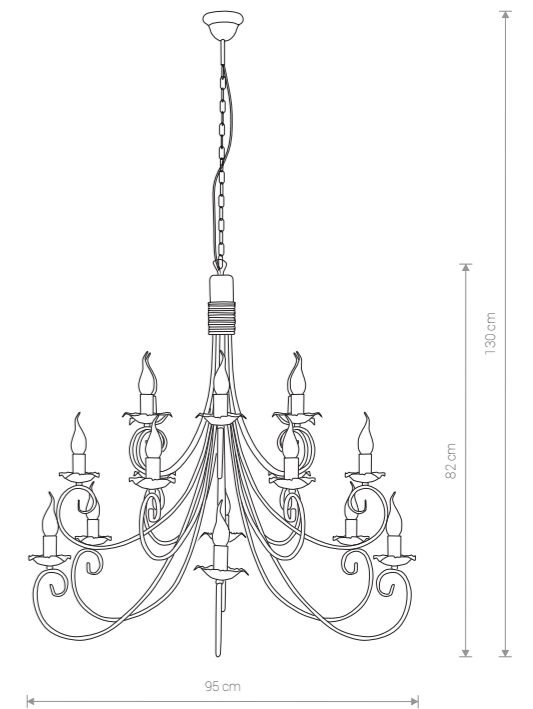

PŁOMYK

stal lakierowana / painted steel / лакированная сталь

493 ● BL/CO

Ⓢ 18×E14, max 60W



ARES 206 BL/G

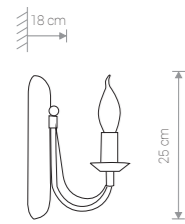

ARES

stal lakierowana / painted steel /
лакированная сталь

202 ● BL/G

Ⓢ 1×E14, max 60W

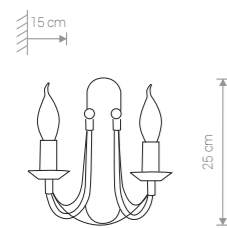

ARES

stal lakierowana / painted steel /
лакированная сталь

203 ● BL/G

Ⓢ 2×E14, max 60W

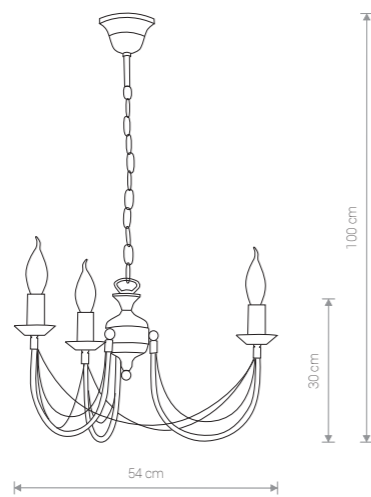

ARES

stal lakierowana / painted steel /
лакированная сталь

204 ● BL/G

Ⓢ 3×E14, max 60W

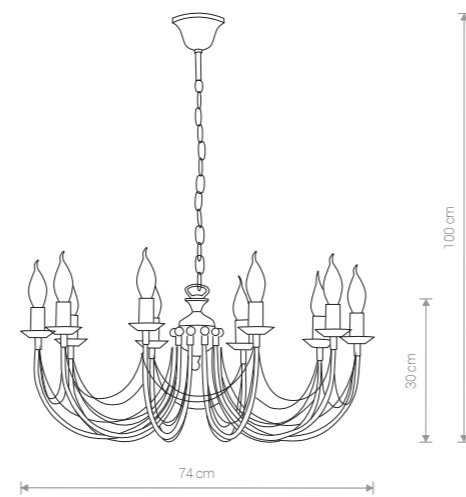

ARES

stal lakierowana / painted steel /
лакированная сталь

206 ● BL/G

Ⓢ 10×E14, max 60W

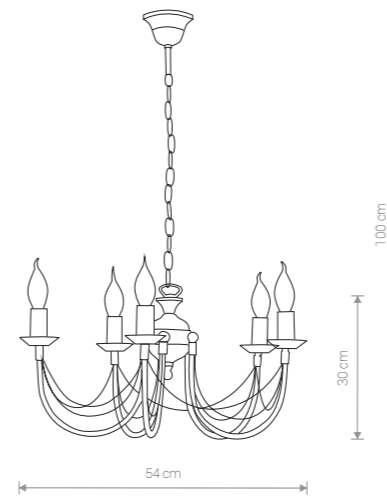

ARES

stal lakierowana / painted steel /
лакированная сталь

205 ● BL/G

Ⓢ 5×E14, max 60W

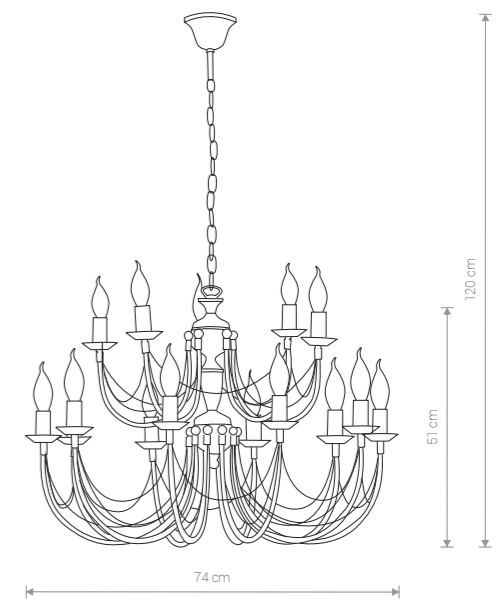

ARES

stal lakierowana / painted steel /
лакированная сталь

208 ● BL/G

Ⓢ 15×E14, max 60W



ARES 208 BL/G



DAKAR 3648 BL/G

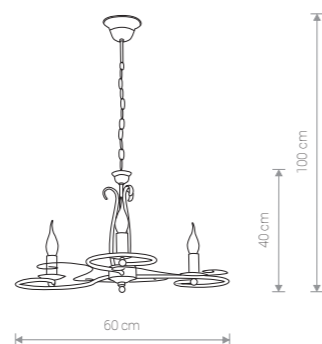
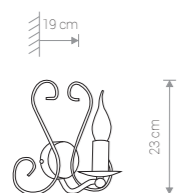

DAKAR

stal lakierowana / painted steel /
лакированная сталь

3644 ● BL/G

Ⓛ 1×E14, max 60W

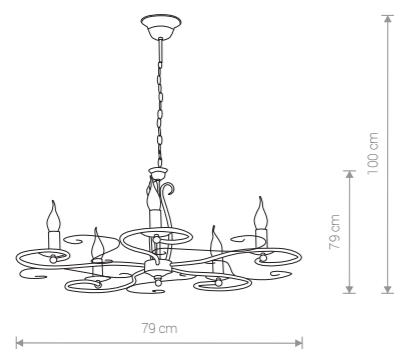

DAKAR

stal lakierowana / painted steel /
лакированная сталь

3646 ● BL/G

Ⓛ 5×E14, max 60W

DAKAR

stal lakierowana / painted steel /
лакированная сталь

3645 ● BL/G

Ⓛ 3×E14, max 60W

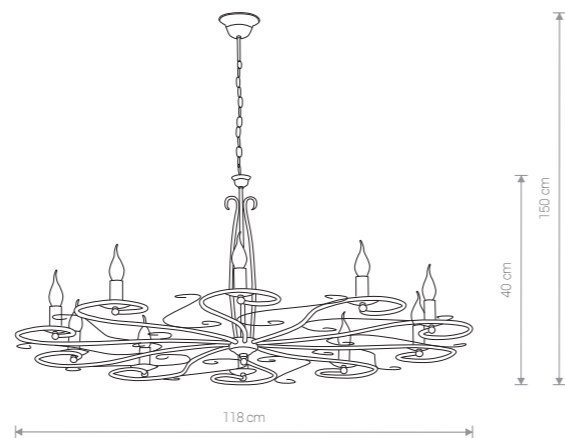

DAKAR

stal lakierowana / painted steel /
лакированная сталь

3648 ● BL/G

Ⓛ 10×E14, max 60W



DAKAR 3650 BL/G

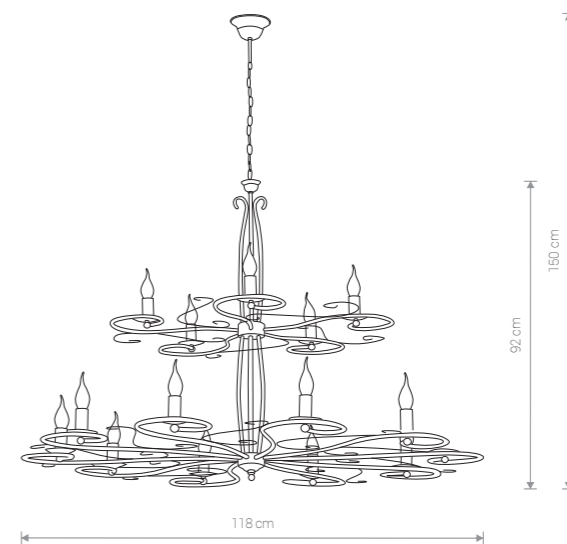

DAKAR

stal lakierowana / painted steel /
лакированная сталь

3650 ● BL/G

Ⓛ 15×E14, max 60W



WIOLETTA 1353 BL/CO

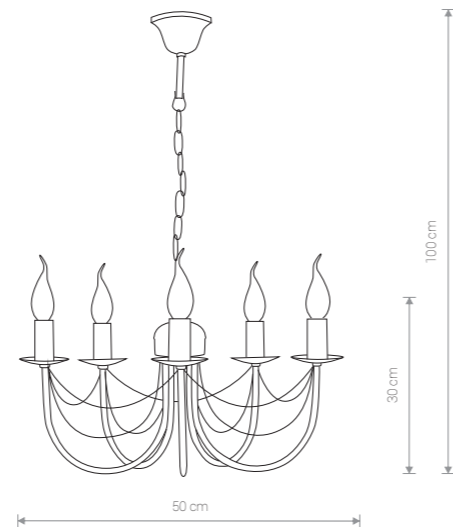

WIOLETTA

stal lakierowana / painted steel /
лакированная сталь

1353 ● BL/CO

Ⓢ 5×E14, max 60W



AMARA 4136 BR/G

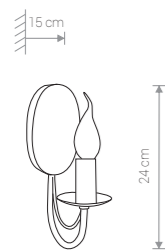

WIOLETTA

stal lakierowana, abażur / painted steel, shade /
лакированная сталь, абажур

1350 ● BL/CO

Ⓢ 1×E14, max 60W

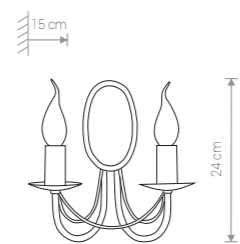

WIOLETTA

stal lakierowana, abażur / painted steel, shade /
лакированная сталь, абажур

1351 ● BL/CO

Ⓢ 2×E14, max 60W

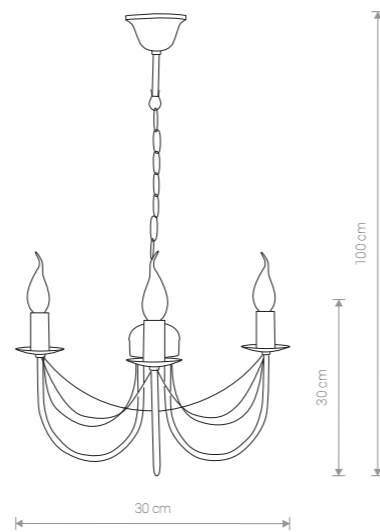

WIOLETTA

stal lakierowana, abażur / painted steel, shade /
лакированная сталь, абажур

1352 ● BL/CO

Ⓢ 3×E14, max 60W

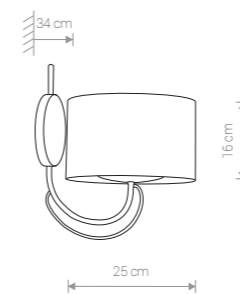

AMARA

stal lakierowana, abażur / painted steel, shade /
лакированная сталь, абажур

4134 ● BR/G

Ⓢ 1×E14, max 60W

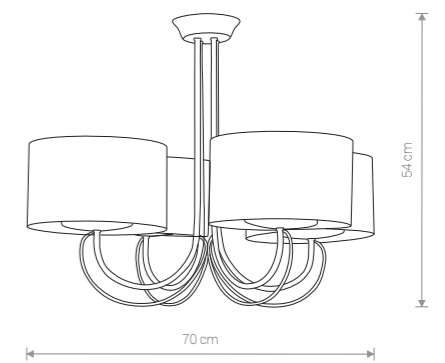

AMARA

stal lakierowana, abażur / painted steel, shade /
лакированная сталь, абажур

4136 ● BR/G

Ⓢ 4×E14, max 60W



bent glass

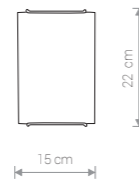

ROSETTE

szkło / glass / стекло

5692 ○ WH

1×E14, max 40W

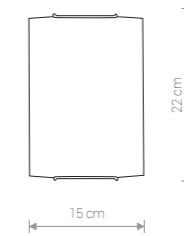

22 cm

15 cm

LUX MAT

szkło / glass / стекло

2267 ○ WH

1×E14, max 40W

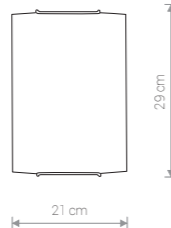

ROSETTE

szkło / glass / стекло

5694 ○ WH

1×E27, max 60W

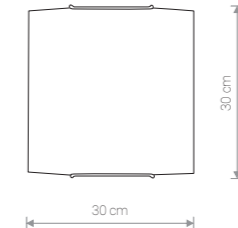

30 cm

30 cm

LUX MAT

szkło / glass / стекло

2272 ○ WH

1×E27, max 60W

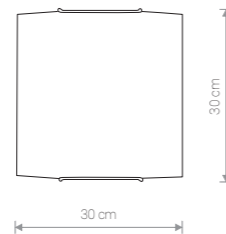

ROSETTE

szkło / glass / стекло

5760 ○ WH

1×E27, max 60W

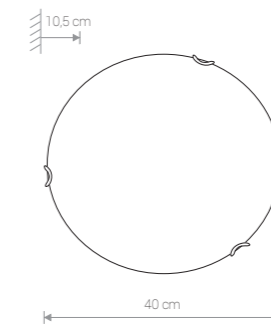

10.5 cm

40 cm

LUX MAT

szkło / glass / стекло

2274 ○ WH

2×E27, max 60W

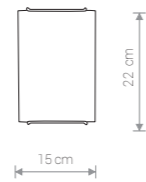

CLASSIC

szkło / glass / стекло

1129 ○ WH

1×E14, max 40W

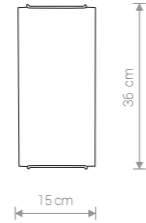

CLASSIC

szkło / glass / стекло

1130 ○ WH

2×E14, max 40W

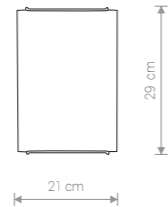

CLASSIC

szkło / glass / стекло

1131 ○ WH

1×E27, max 60W

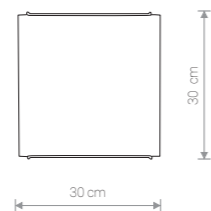

CLASSIC

szkło / glass / стекло

1135 ○ WH

1×E27, max 60W

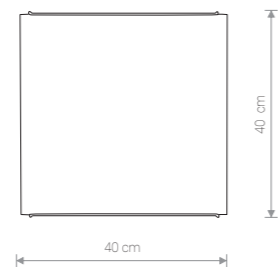

CLASSIC

szkło / glass / стекло

1136 ○ WH

2×E27, max 60W

4923 ○ WH

4×E27, max 60W

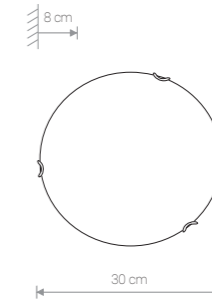

CLASSIC

szkło / glass / стекло

3908 ○ WH

1×E27, max 60W

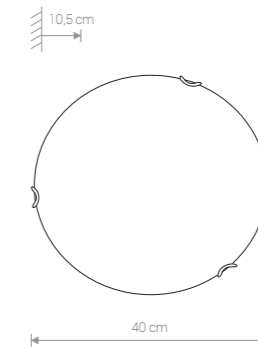

CLASSIC

szkło / glass / стекло

3910 ○ WH

2×E27, max 60W

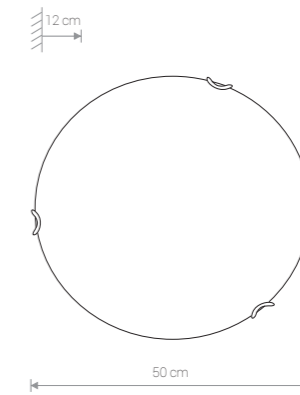

CLASSIC

szkło / glass / стекло

3912 ○ WH

3×E27, max 60W

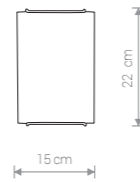

CONTRASTAMPO

szkło / glass / стекло

2280 ● EC

1×E14, max 40W

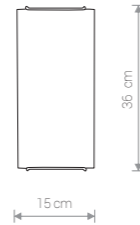

CONTRASTAMPO

szkło / glass / стекло

2281 ● EC

2×E14, max 40W

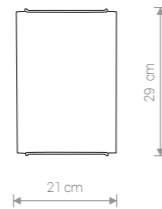

CONTRASTAMPO

szkło / glass / стекло

2282 ● EC

1×E27, max 60W

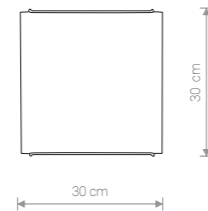

CONTRASTAMPO

szkło / glass / стекло

2283 ● EC

1×E27, max 60W

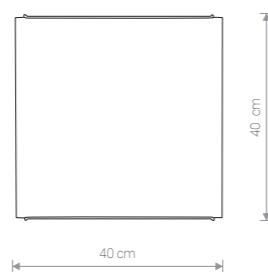

CONTRASTAMPO

szkło / glass / стекло

3571 ● EC

2×E27, max 60W

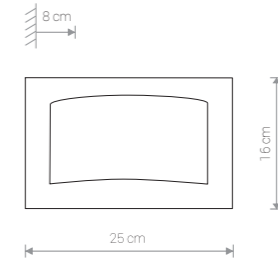

HIRO

stal, szkło / steel, glass / сталь, стекло

4525 ● SI

1×E14, max 40W

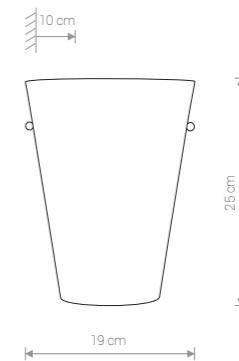

CONO CLASSIC

szkło, stal / glass, steel / стекло, сталь

2205 ○ WH

1×E27, max 60W

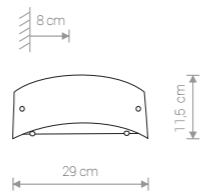

VELVET

szkło, stal / glass, steel / стекло, сталь

2470 ○ WH

1×E14, max 40W

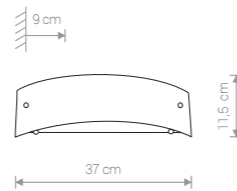

VELVET

szkło, stal / glass, steel / стекло, сталь

2469 ○ WH

1×E27, max 60W

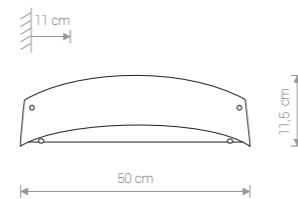

VELVET

szkło, stal / glass, steel / стекло, сталь

2468 ○ WH

2×E27, max 60W



CANALINA CLASSIC

szkło / glass / стекло

1339 ○ WH

3×E14, max 40W

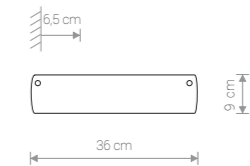

CANALINA CLASSIC

szkło / glass / стекло

1338 ○ WH

2×E14, max 40W

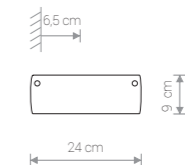

CANALINA CLASSIC

szkło / glass / стекло

1337 ○ WH

1×E14, max 40W

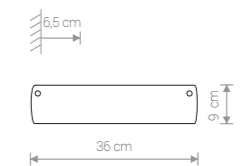

CANALINA ZEBRA

szkło / glass / стекло

1157 ○ WH

2×E14, max 40W

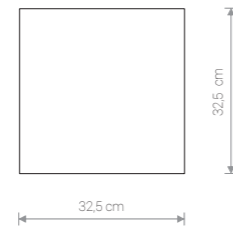

OSAKA SQUARE

drewno, szkło / wood, glass / дерево, стекло

4976 ○ WH 2902 ● WE

Ⓛ 2×E27, max 60W

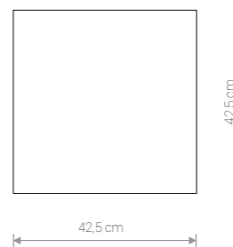

OSAKA SQUARE

drewno, szkło / wood, glass / дерево, стекло

4977 ○ WH 2903 ● WE

Ⓛ 4×E27, max 60W

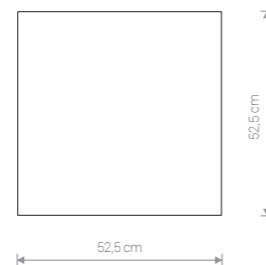

OSAKA SQUARE

drewno, szkło / wood, glass / дерево, стекло

4978 ○ WH 2904 ● WE

Ⓛ 4×E27, max 60W

OSAKA SQUARE 4976 WH

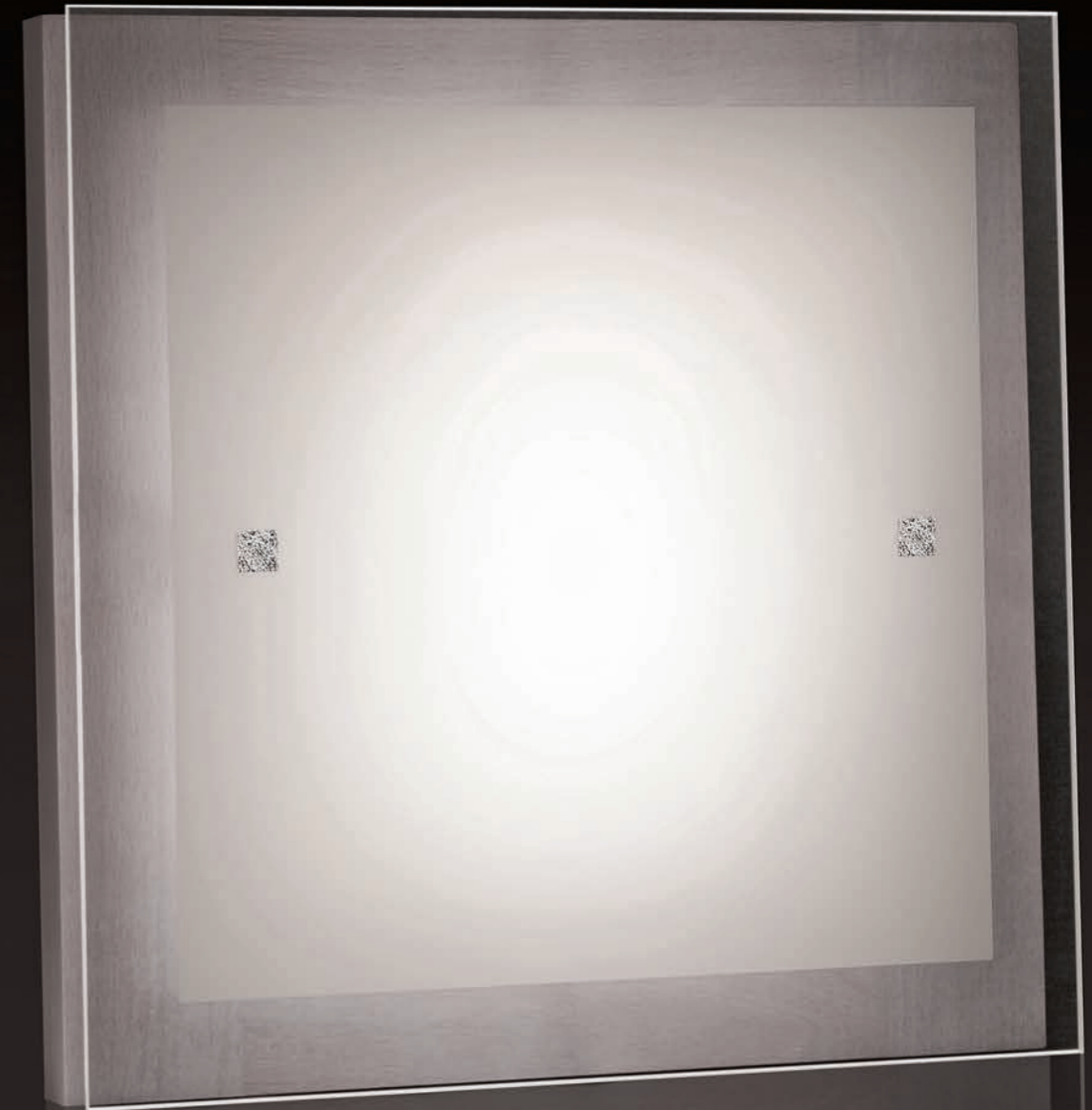

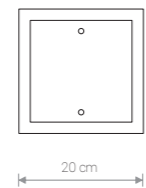

KYOTO

drewno, szkło / wood, glass / дерево, стекло

3765 ● WE

1×G9, max 50W, 230V

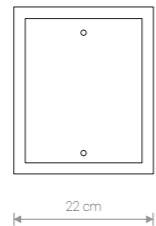

KYOTO

drewno, szkło / wood, glass / дерево, стекло

3413 ● WE

1×E14, max 40W

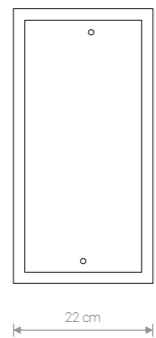

KYOTO

drewno, szkło / wood, glass / дерево, стекло

3414 ● WE

2×E14, max 40W

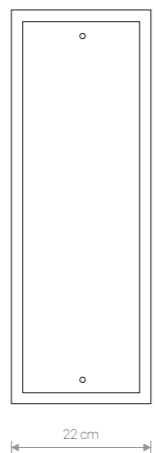

KYOTO

drewno, szkło / wood, glass / дерево, стекло

3415 ● WE

3×E14, max 40W



KYOTO SHINE

drewno, szkło / wood, glass / дерево, стекло

5588 ○ WH

2×E14, max 40W



KYOTO SHINE

drewno, szkło / wood, glass / дерево, стекло

5590 ○ WH

3×E14, max 40W



KENDO

stal, szkło / steel, glass / сталь, стекло

4301 ● SI

Ⓛ 1×E27, max 60W

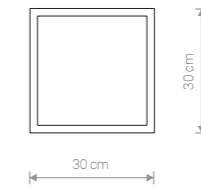

NAGANO

drewno, szkło / wood, glass / дерево, стекло

4290 ● WE

Ⓛ 2×E27, max 60W



KENDO

stal, szkło / steel, glass / сталь, стекло

4302 ● SI

Ⓛ 2×E27, max 60W

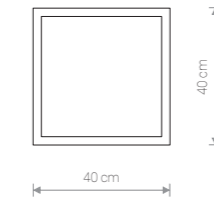

NAGANO

drewno, szkło / wood, glass / дерево, стекло

4291 ● WE

Ⓛ 4×E27, max 60W



KENDO

stal, szkło / steel, glass / сталь, стекло

4303 ● SI

Ⓛ 4×E27, max 60W

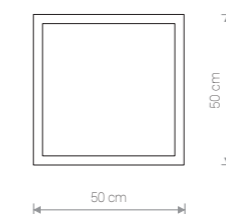

NAGANO

drewno, szkło / wood, glass / дерево, стекло

4292 ● WE

Ⓛ 4×E27, max 60W



kids

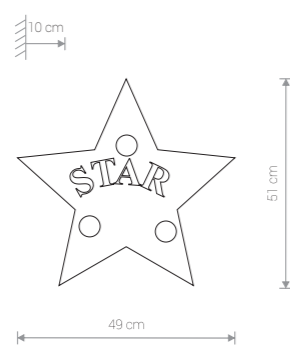

TOY-STAR

sklejka, stal lakierowana / plywood, painted steel / дерево, лакированная сталь

9293 ● GY

Ⓧ 3×E14, max 40W

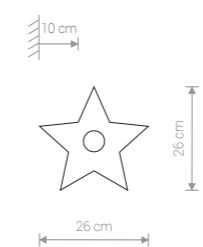

TOY-STAR

sklejka, stal lakierowana / plywood, painted steel / дерево, лакированная сталь

9376 ● GY

Ⓧ 1×E14, max 40W

HEART 9063 GY/P

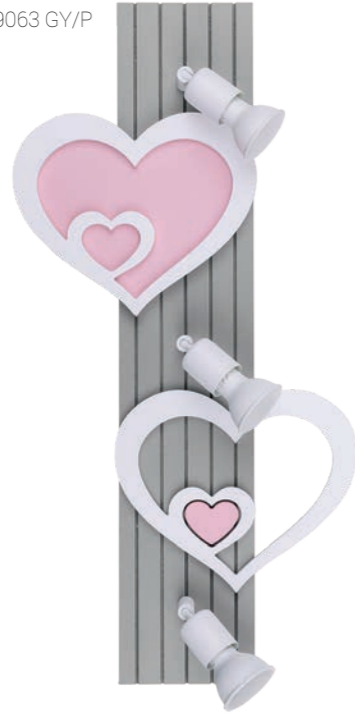

HEART 9062 GY/P



HEART 9064 GY/P

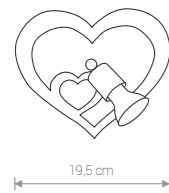

HEART

sklejka, stal lakierowana / plywood, painted steel /
дерево, лакированная сталь

9062 GY/P

1xGU10, max 35W



HEART

sklejka, stal lakierowana / plywood, painted steel /
дерево, лакированная сталь

9064 GY/P

3xGU10, max 35W

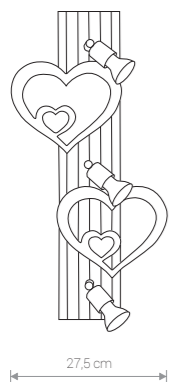

HEART

sklejka, stal lakierowana / plywood, painted steel /
дерево, лакированная сталь

9063 GY/P

3xGU10, max 35W

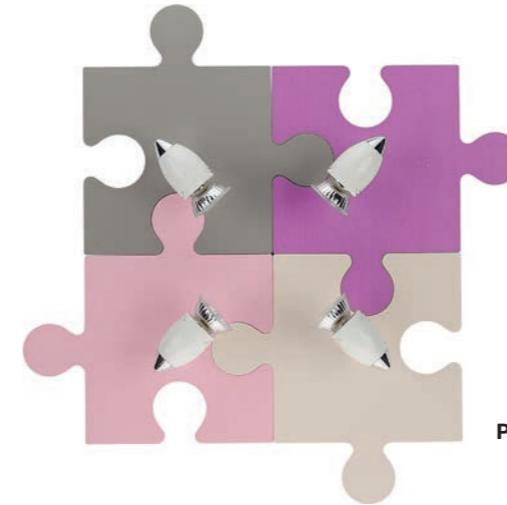

PUZZLE 6384

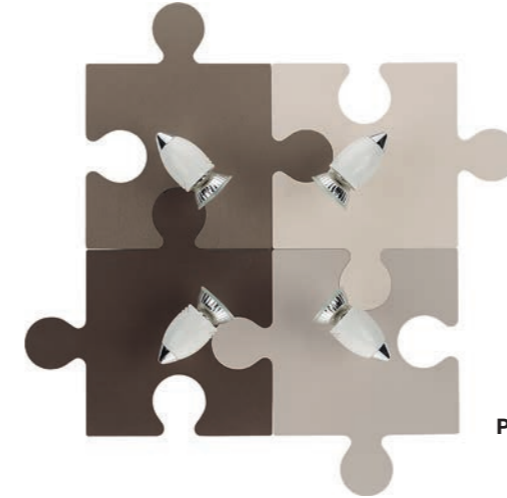

PUZZLE 6382

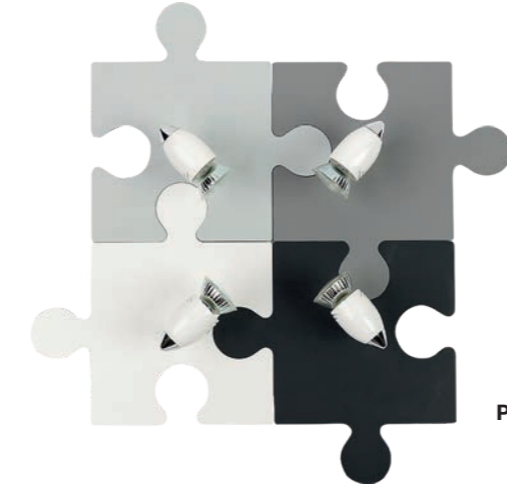

PUZZLE 9728

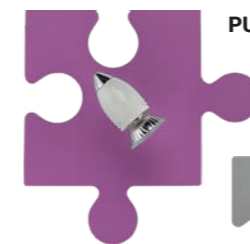

PUZZLE 6383 P



PUZZLE 9730 GY

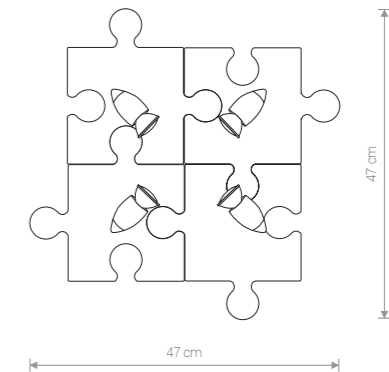

PUZZLE

sklejka, PA / plywood, PA / дерево, PA

6384 6382 9728

4xGU10, max 15W

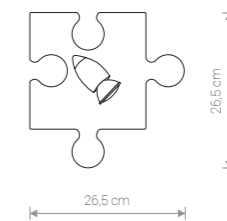

PUZZLE

sklejka, PA / plywood, PA / дерево, PA

6383 P 9730 GY

1xGU10, max 15W



SIGNPOST 9066 AN GY

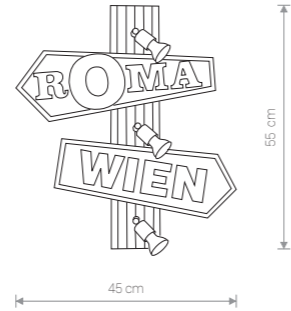

SIGNPOST

sklejka, stal lakierowana / plywood, painted steel /
дерево, лакированная сталь

9066 AN GY

3xGU10, max 35W

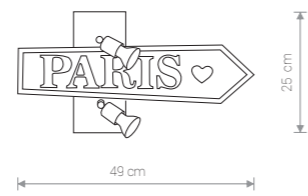

SIGNPOST

sklejka, stal lakierowana / plywood, painted steel /
дерево, лакированная сталь

9065 AN GY

2xGU10, max 35W

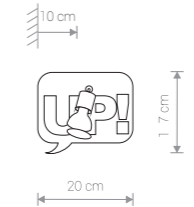

COMIC BOOK

sklejka, stal lakierowana / plywood, painted steel /
дерево, лакированная сталь

9290 GY/M

1xGU10, max 35W

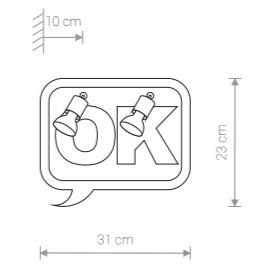

COMIC BOOK

sklejka, stal lakierowana / plywood, painted steel /
дерево, лакированная сталь

9286 GY/M

2xGU10, max 35W

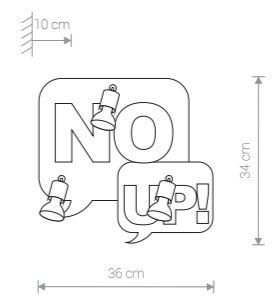

COMIC BOOK

sklejka, stal lakierowana / plywood, painted steel /
дерево, лакированная сталь

9285 GY/M

3xGU10, max 35W

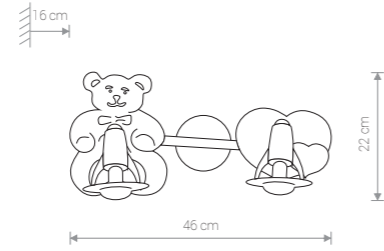

HONEY

sklejka, PET, PC, stal / plywood, PET, PC, steel /
дерево, PET, PC, сталь

3657 P/EC

2×E14, R50, 40W

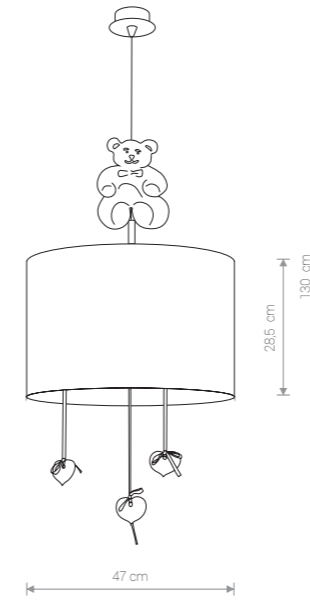

HONEY

abazur, stal lakierowana, sklejka / shade, painted steel, plywood /
абажур, лакирована сталь, дерево

6615 P/EC

1×E27, max 60W

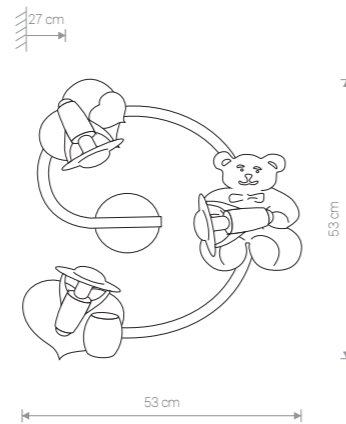

HONEY

sklejka, PET, PC, stal / plywood, PET, PC, steel /
дерево, PET, PC, сталь

3660 P/EC

3×E14, R50, 40W

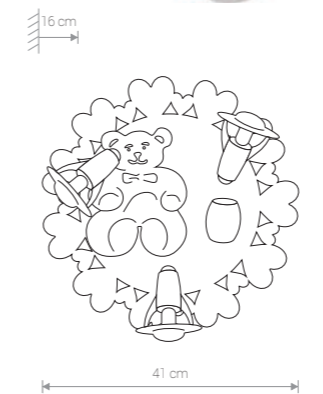

HONEY

sklejka, PET, PC, stal / plywood, PET, PC, steel /
дерево, PET, PC, сталь

3661 P/EC

3×E14, R50, 40W

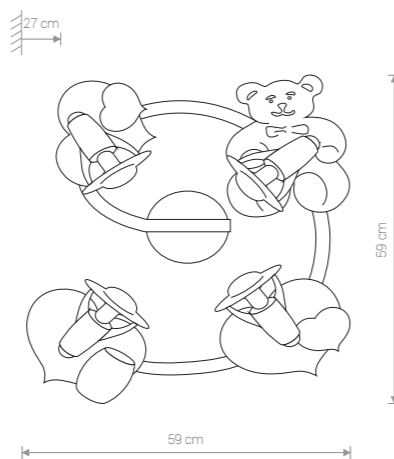

HONEY

sklejka, PET, PC, stal / plywood, PET, PC, steel /
дерево, PET, PC, сталь

3662 P/EC

4×E14, R50, 40W



HONEY

sklejka, PET, PC, stal / plywood, PET, PC, steel /
дерево, PET, PC, сталь

3656 P/EC

1×E14, R50, 40W



FLOWERS 6896 P

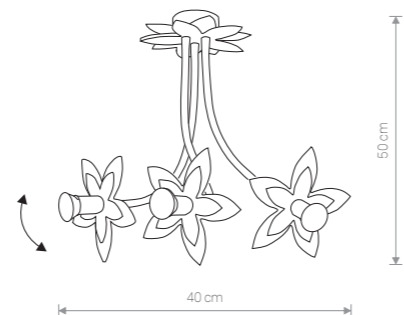

FLOWERS

sklejka, peszel / plywood, protective pipe /
дерево, кабель-канал

6894 P 6898 G

3xGU10, max 35W

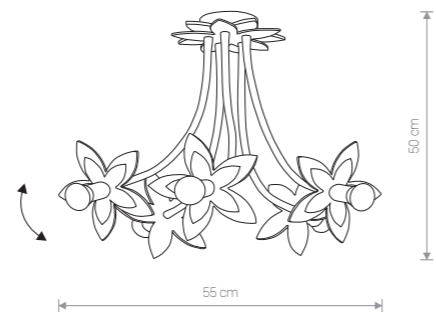

FLOWERS

sklejka, peszel / plywood, protective pipe /
дерево, кабель-канал

6896 P 6901 G

5xGU10, max 35W



FLOWERS 6897 G

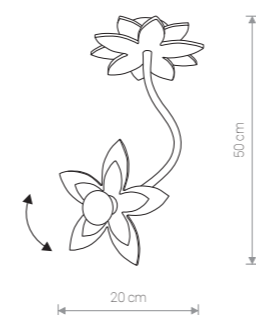

FLOWERS

sklejka, peszel / plywood, protective pipe /
дерево, кабель-канал

6893 P 6897 G

1xGU10, max 35W



FLOWERS 6895 P

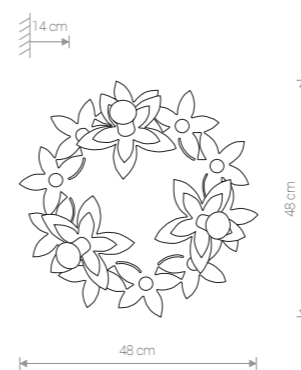

FLOWERS

sklejka, peszel / plywood, protective pipe /
дерево, кабель-канал

6895 P 6900 G

3xGU10, max 35W





PLANE 6904 B/GY



PLANE 6904 B/GY



PLANE 6902 B/GY



PLANE 6903 B/GY

53 cm

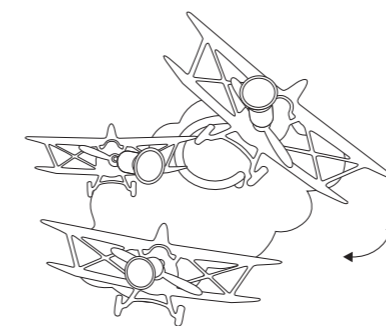

53 cm

PLANE

sklejka, peszel / plywood, protective pipe /
дерево, кабель-канал

6904 B/GY

3xGU10, max 35W

12 cm

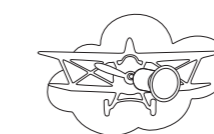

28,5 cm

PLANE

sklejka, peszel / plywood, protective pipe /
дерево, кабель-канал

6902 B/GY

1xGU10, max 35W

53 cm

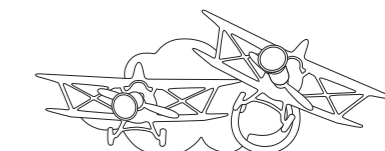

49 cm

PLANE

sklejka, peszel / plywood, protective pipe /
дерево, кабель-канал

6903 B/GY

2xGU10, max 35W

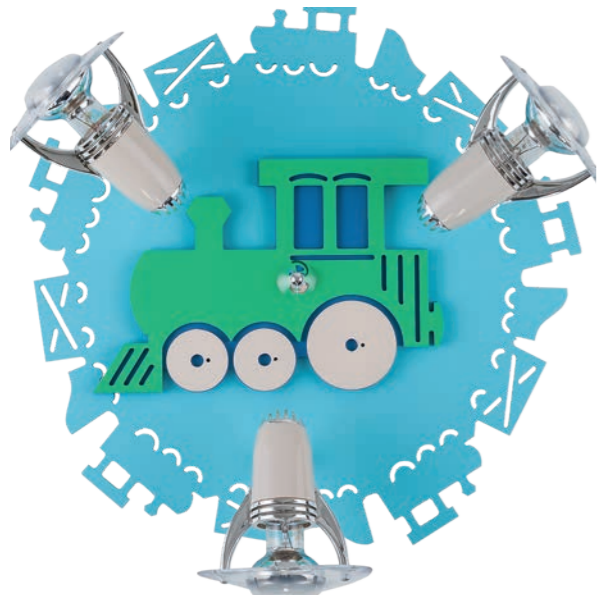

TRAIN 4064 B/GN

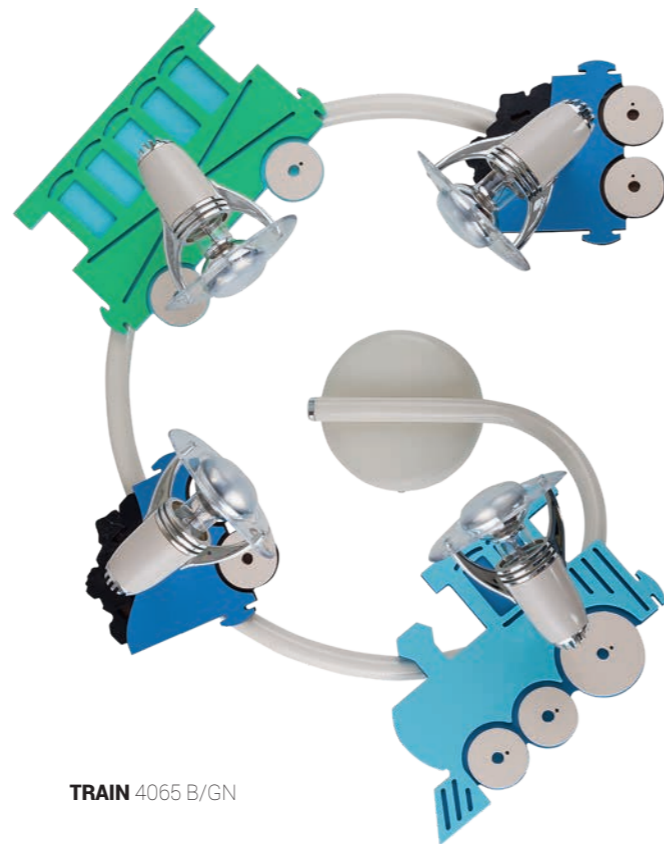

TRAIN 4065 B/GN



GUITAR 4223



GITARRA 4326

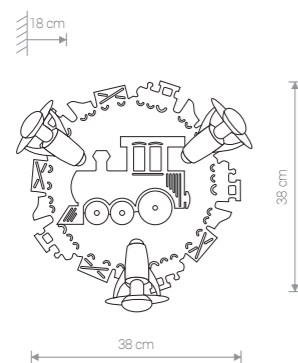

TRAIN

sklejka, PET, PC, stal / plywood, PET, PC, steel /
дерево, PET, PC, сталь

4064 ● B/GN

Ⓢ 3×E14, R50, max 40W

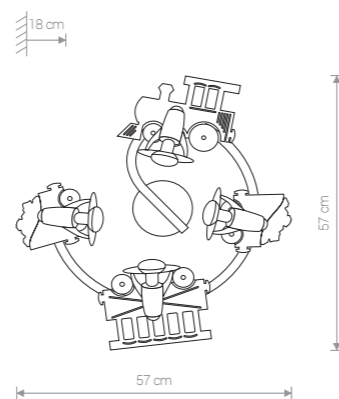

TRAIN

sklejka, PET, PC, stal / plywood, PET, PC, steel /
дерево, PET, PC, сталь

4065 ● B/GN

Ⓢ 4×E14, R50, max 40W

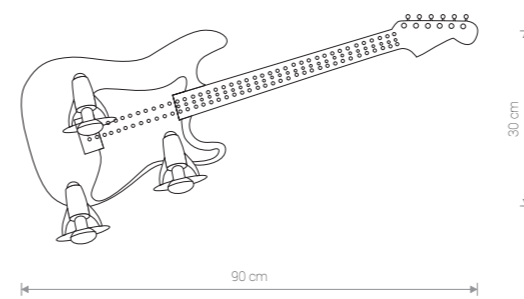

GUITAR

sklejka, PET, PC, stal / plywood, PET, PC, steel /
дерево, PET, PC, сталь

4223 ● R/WH

Ⓢ 3×E14, R50, 78 LED blue, max 40W, **included**

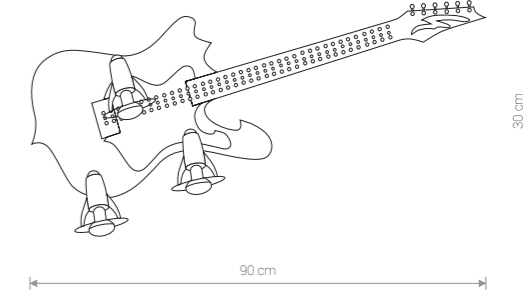

GITARRA

sklejka, PET, PC, stal / plywood, PET, PC, steel /
дерево, PET, PC, сталь

4326 ● BR/WH

Ⓢ 3×E14, R50, 78 LED blue, max 40W, **included**

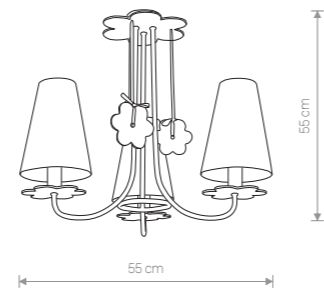

PRASLIN

abażur, stal lakierowana, sklejka / shade, painted steel, plywood / абажур, лакирована сталь, дерево,

5304 WH/P

3×E14, max 40W

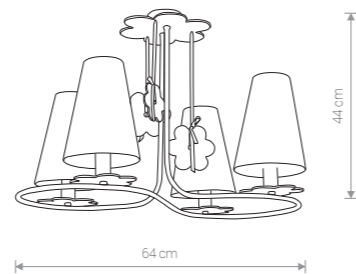

PRASLIN

abażur, stal lakierowana, sklejka / shade, painted steel, plywood / абажур, лакирована сталь, дерево,

5303 WH/P

4×E14, max 40W



PRASLIN 5302 WH/P

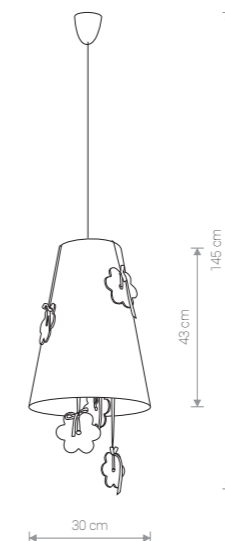

PRASLIN

abażur, stal lakierowana, sklejka / shade, painted steel, plywood / абажур, лакирована сталь, дерево,

5302 WH/P

1×E27, max 60W



MALWI 6736 B



MALWI 6326 P

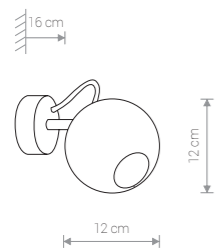

MALWI

stal lakierowana / painted steel / лакирована сталь

6326 P 6736 B

1xGU10, max 35W

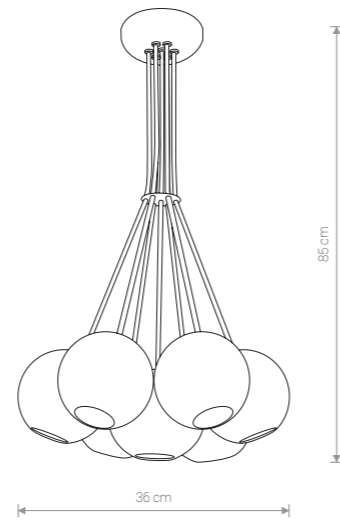

MALWI

stal lakierowana / painted steel / лакирована сталь

6327

7xGU10, max 35W



MALWI 6327



bathroom



VAN GOGH LED L 9176 CH



VAN GOGH LED S 9346 CH

VAN GOGH LED M 9350 WH

VAN GOGH LED L 9174 BL

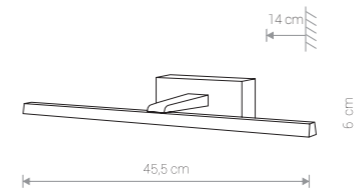

VAN GOGH LED S

aluminium, PC / aluminium, PC / алюминий, PC

9346 ● CH 9348 ○ WH 9351 ● BL

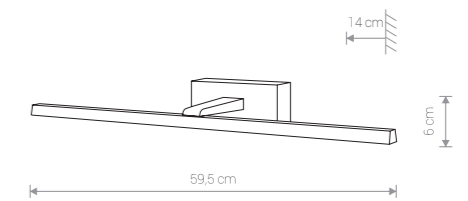

VAN GOGH LED M

aluminium, PC / aluminium, PC / алюминий, PC

9347 ● CH 9350 ○ WH 9352 ● BL

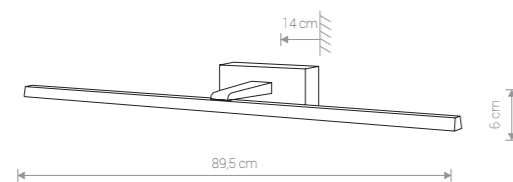

VAN GOGH LED L

aluminium, PC / aluminium, PC / алюминий, PC

9176 ● CH 9175 ○ WH 9174 ● BL

Item No.	POWER	COLOUR TEMP.	LUMINOUS FLUX	BEAM ANGLE	COLOUR RENDERING INDEX (CRI ≥)	SAFETY TYPE	INPUT	POWER FACTOR	INGRESS PROTECTION
9346, 9348, 9351	8W LED EPISTAR	3000K	447 lm	120°	80	⊕	~220-240V, 50Hz	> 0,5	IP 44
9347, 9350, 9352	12W LED EPISTAR	3000K	795 lm	120°	80	⊕	~220-240V, 50Hz	> 0,5	IP 44
9174, 9175, 9176	18W LED EPISTAR	3000K	976 lm	120°	80	⊕	~220-240V, 50Hz	> 0,5	IP 44



MIRROR LED 9340 CH

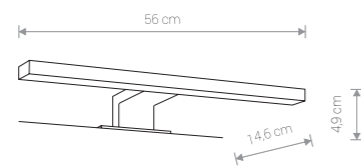

MIRROR LED

aluminium, PC / aluminium, PC / алюминий, PC

9340 CH

Item No.	POWER	COLOUR TEMP.	LUMINOUS FLUX	BEAM ANGLE	COLOUR RENDERING INDEX (CRI ≥)	SAFETY TYPE	INPUT	POWER FACTOR	INGRESS PROTECTION
9340	8W LED EPISTAR	3000K	600 lm	90°	80	□	~220-240V, 50Hz	> 0,5	IP 44



KAMERA LED L 9502 CH

KAMERA LED M 9503 CH

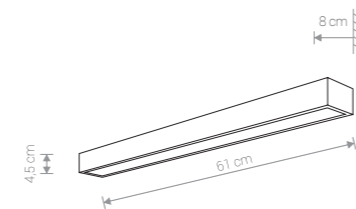

KAMERA LED M

szkło, PMMA, aluminium chromowane / glass, PMMA, electroplated aluminium / стекло, PMMA, хромированное алюминий

9503 CH

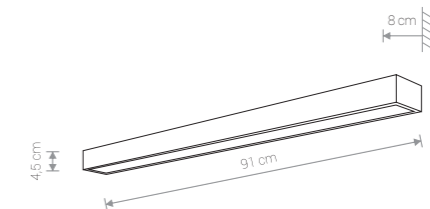

KAMERA LED L

szkło, PMMA, aluminium chromowane / glass, PMMA, electroplated aluminium / стекло, PMMA, хромированное алюминий

9502 CH

Item No.	POWER	COLOUR TEMP.	LUMINOUS FLUX	BEAM ANGLE	COLOUR RENDERING INDEX (CRI ≥)	SAFETY TYPE	INPUT	POWER FACTOR	INGRESS PROTECTION
9503	18W LED	4000K	1000 lm	120°	80	⊕	~220-240V, 50Hz	> 0,5	IP 44
9502	24W LED	4000K	1380 lm	120°	80	⊕	~220-240V, 50Hz	> 0,5	IP 44



SPARTA 9157 CH

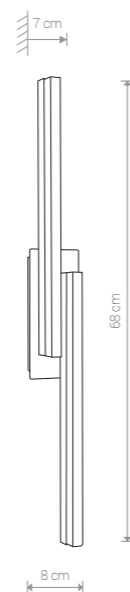

SPARTA

aluminium, acryl, stal chromowana /
aluminium, electroplated steel, acrylic /
алюминий, асрл, хромированное сталь

9157 ● CH

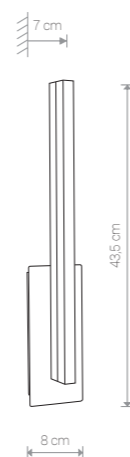

SPARTA

aluminium, acryl, stal chromowana /
aluminium, electroplated steel, acrylic /
алюминий, асрл, хромированное сталь

9156 ● CH



MAKE UP 9504 CH

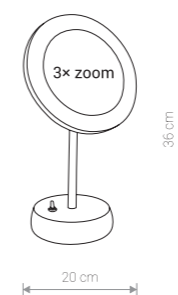

MAKEUP LED

szkto, acryl, stal chromowana / glass, acrylic, electroplated steel /
стекло, асрл, хромированное сталь

9504 ● CH

Item No.	POWER	COLOUR TEMP.	LUMINOUS FLUX	BEAM ANGLE	COLOUR RENDERING INDEX (CRI >=)	INPUT	SAFETY TYPE	POWER FACTOR	INGRESS PROTECTION	LIFETIME
9504	3W LED	4000K	43 lm	120°	80	~200-240V, 50Hz	⊞	0,5	IP 44	10 000 h
9156	6W LED	4000K	400 lm	120°	80	~200-240V, 50Hz	⊕	0,5	IP 44	20 000 h
9157	2x6W LED	4000K	700 lm	120°	80	~200-240V, 50Hz	⊕	0,5	IP 44	20 000 h



CAYO 9505 CH

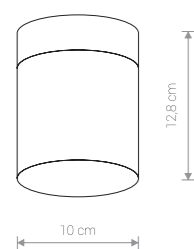

CAYO

szkło, stal chromowana / glass, electroplated steel /
стекло, хромированное сталь

9505 ● CH

1xG9, max 40W
IP 44

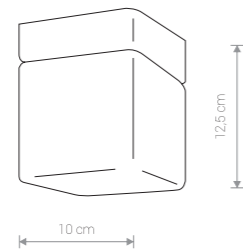

SIS

szkło, stal chromowana / glass, electroplated steel /
стекло, хромированное сталь

9506 ● CH

1xG9, max 40W
IP 44



SIS 9506 CH



BALI 9353 TR



BALI 9354 WH

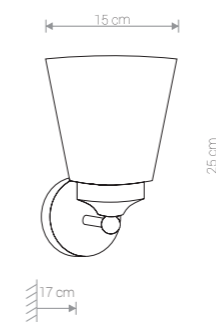

BALI

szkło, stal chromowana / glass, electroplated steel / стекло, хромированное сталь

9353 ● TR 9354 ○ WH

1xE14, max 25W

IP 44

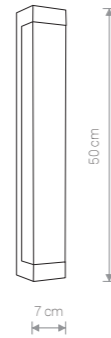

FRASER LED

PMMA, stal chromowana / PMMA, electroplated steel /
PMMA, хромированная сталь

6945 ● CH

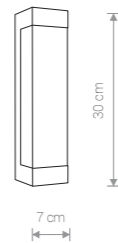

FRASER LED

PMMA, stal chromowana / PMMA, electroplated steel /
PMMA, хромированная сталь

6944 ● CH

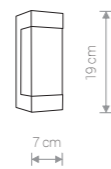

FRASER LED

PMMA, stal chromowana / PMMA, electroplated steel /
PMMA, хромированная сталь

6943 ● CH



BRAZOS

stal chromowana, szkło / electroplated steel, glass /
хромированная сталь, стекло

6948 ● CH

1×G9, max 25W

IP 44



BRAZOS

stal chromowana, szkło / electroplated steel, glass /
хромированная сталь, стекло

6950 ● CH

2×G9, max 25W

IP 44



BRAZOS

stal chromowana, szkło / electroplated steel, glass /
хромированная сталь, стекло

6951 ● CH

3×G9, max 25W

IP 44

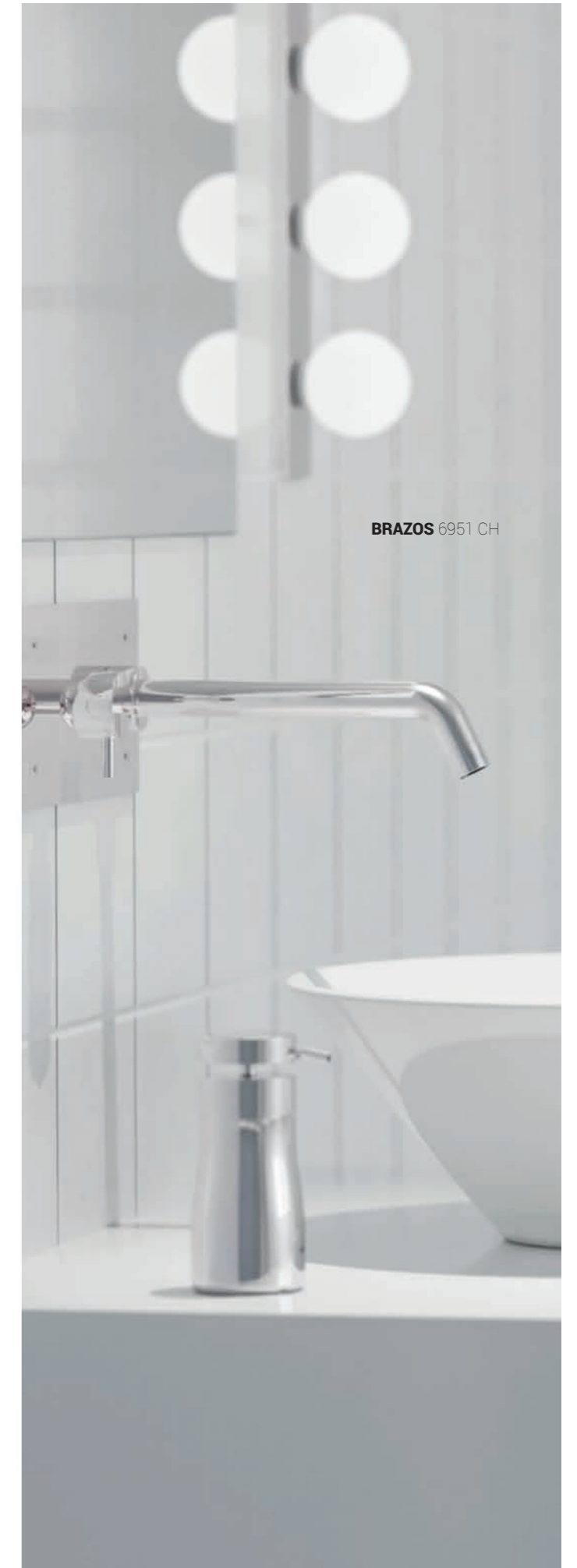

BRAZOS 6951 CH

Item No.	POWER	COLOUR TEMP.	LUMINOUS FLUX	BEAM ANGLE	COLOUR RENDERING INDEX (CRI >)	INPUT	SAFETY TYPE	POWER FACTOR	INGRESS PROTECTION
6943	1×6W LED	4000K	360 lm	120°	80	~220-240V, 50Hz	■	0,8	IP 44
6944	1×8W LED	4000K	420 lm	120°	80	~220-240V, 50Hz	■	0,8	IP 44
6945	1×12W LED	4000K	720 lm	120°	80	~220-240V, 50Hz	■	0,8	IP 44

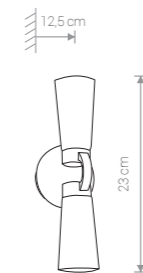

OHIO

stal chromowana, szkło / electroplated steel, glass /
хромированная сталь, стекло

3564 ● CH

⚡ 2×G9, max 40W, **included**

IP 44

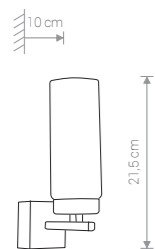

CELTIC

stal chromowana, szkło / electroplated steel, glass /
хромированная сталь, стекло

3346 ● CH

⚡ 1×E14, max 40W

IP 44

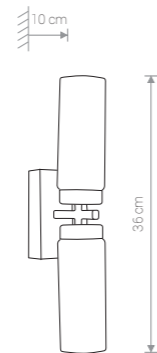

CELTIC

stal chromowana, szkło / electroplated steel, glass /
хромированная сталь, стекло

3347 ● CH

⚡ 2×E14, max 40W

IP 44

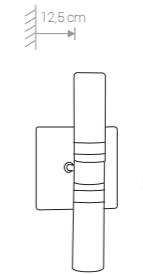

BALTIC

stal chromowana, szkło / electroplated steel, glass /
хромированная сталь, стекло

3350 ● CH

⚡ 2×G9, max 40W, **included**

IP 44

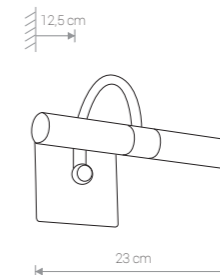

BALTIC

stal chromowana, szkło / electroplated steel, glass /
хромированная сталь, стекло

4386 ● CH

⚡ 2×G9, max 25W, **included**

IP 44

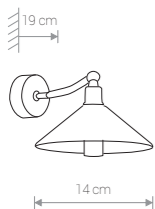

MILTON

stal chromowana, szkło / electroplated steel, glass /
хромированная сталь, стекло

5264 ● CH

⚡ 1×G9, max 40W, **included**

IP 44

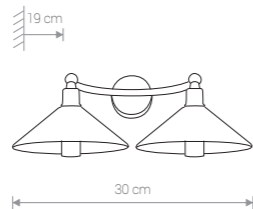

MILTON

stal chromowana, szkło / electroplated steel, glass /
хромированная сталь, стекло

5265 ● CH

⚡ 2×G9, max 40W, **included**

IP 44



MALAKKA LED 9501 CH



BASSA LED 9500 CH

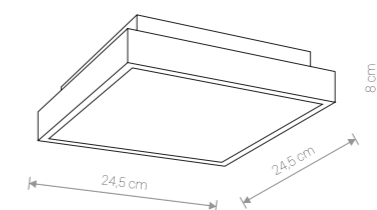

BASSA LED

acryl, aluminium chrom / acryl, aluminium chrome / акрил, алюминиевый хром

9500 ● CH

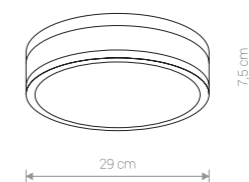

MALAKKA LED

szkło, stal chromowana / glass, electroplated steel / стекло, хромированная сталь

9501 ● CH

Item No.	POWER	COLOUR TEMP.	LUMINOUS FLUX	BEAM ANGLE	COLOUR RENDERING INDEX (CRI ≥)	SAFETY TYPE	INPUT	POWER FACTOR	INGRESS PROTECTION
9500	18W LED	4000K	750 lm	120°	80	⊕	~220-240V, 50Hz	> 0,5	IP 44
9501	18W LED	4000K	940 lm	120°	80	⊕	~220-240V, 50Hz	> 0,5	IP 44



ARENA LED 6771 SI



ARENA 6725 GR



ARENA 6724 WH

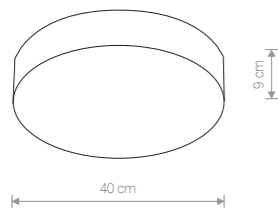

ARENA

stal chromowana, szkło / electroplated steel, glass /
хромированная сталь, стекло

6724 ○ WH 6770 ○ SI 6725 ● GR

3×E14, max 20W
IP 44

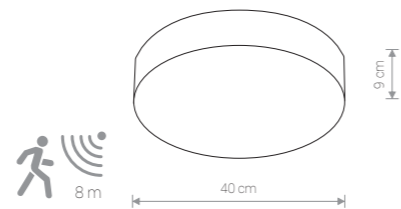

ARENA SENSOR

stal chromowana, szkło / electroplated steel, glass /
хромированная сталь, стекло

8832 ○ WH 8833 ● GR

3×E14, max 20W
IP 44



ARENA LED 6727 GR

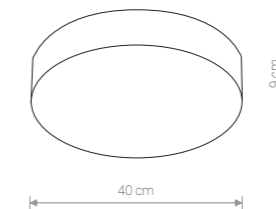

ARENA LED

stal chromowana, szkło / electroplated steel, glass /
хромированная сталь, стекло

6726 ○ WH 6771 ○ SI 6727 ● GR

IP 44

Item No.	POWER	COLOUR TEMP.	LUMINOUS FLUX	BEAM ANGLE	COLOUR RENDERING INDEX (CRI →)	INPUT	SAFETY TYPE	POWER FACTOR	INGRESS PROTECTION
6726	20W LED	4000K	1600 lm	140°	80	~220-240V, 50Hz	⊕	0,95	IP 44
6771	20W LED	4000K	1600 lm	140°	80	~220-240V, 50Hz	⊕	0,95	IP 44
6727	20W LED	4000K	1600 lm	140°	80	~220-240V, 50Hz	⊕	0,95	IP 44



TAHOE 3118 CH

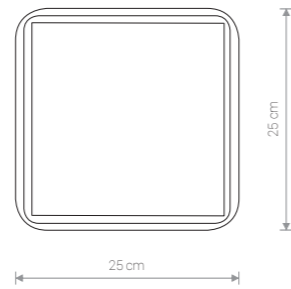

TAHOE

PC, ABS / PC, ABS / PC, ABS

3118 ● CH 3250 ○ WH 3122 ● SI

1×E27, max 23W
IP 65

3240 ● CH 3251 ○ WH 3242 ● BR
3243 ● SI 3244 ● G

2×E27, max 23W
IP 65



TAHOE 3244 G

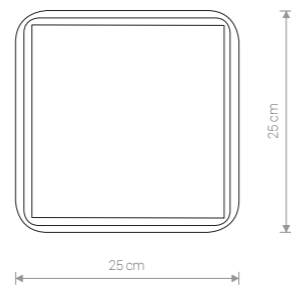

TAHOE SENSOR

PC, ABS / PC, ABS / PC, ABS

8831 ● CH 8830 ○ WH

2×E27, max 23W
IP 65

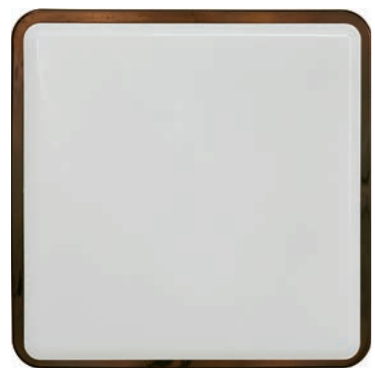

TAHOE 3242 BR

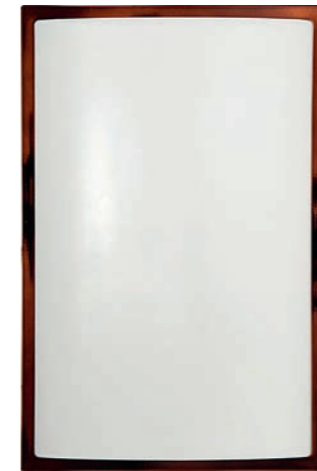

GARDA 3755 BR



GARDA 3750 WH

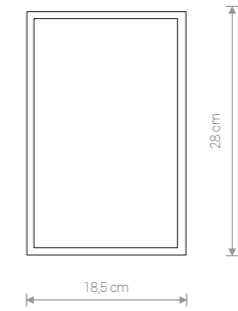

GARDA

PC, ABS / PC, ABS / PC, ABS

3752 ● CH 3750 ○ WH 3755 ● BR

1×E27, max 23W
IP 65



GARDA 3752 CH



cloud forms

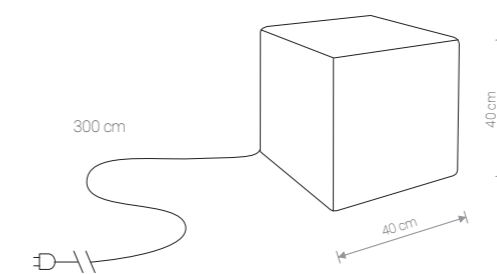

CUMULUS CUBE M

PE / PE / PE

8966 ○ WH

1×E27, max 60W

IP 44

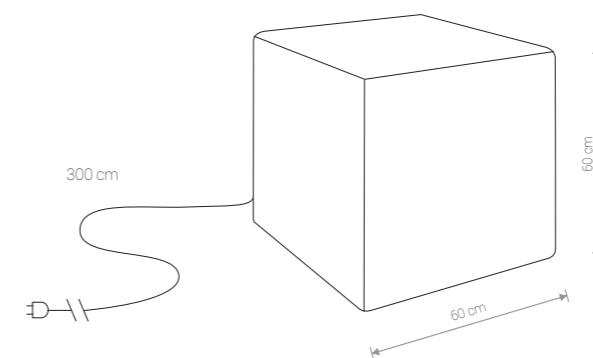

CUMULUS CUBE L

PE / PE / PE

8965 ○ WH

1×E27, max 60W

IP 44



CUMULUS S 9751 WH



CUMULUS M 9715 WH

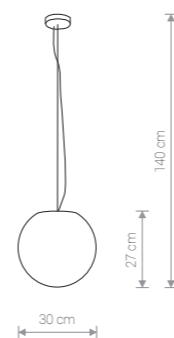

CUMULUS S

PE / PE / PE

9751 ○ WH

1×E27, max 60W

IP 65

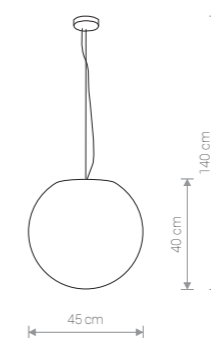

CUMULUS M

PE / PE / PE

9715 ○ WH

1×E27, max 60W

IP 65

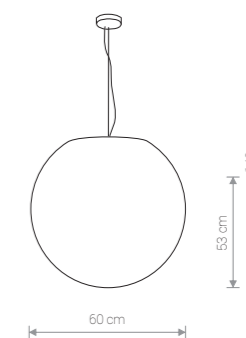

CUMULUS L

PE / PE / PE

9607 ○ WH

1×E27, max 60W

IP 65

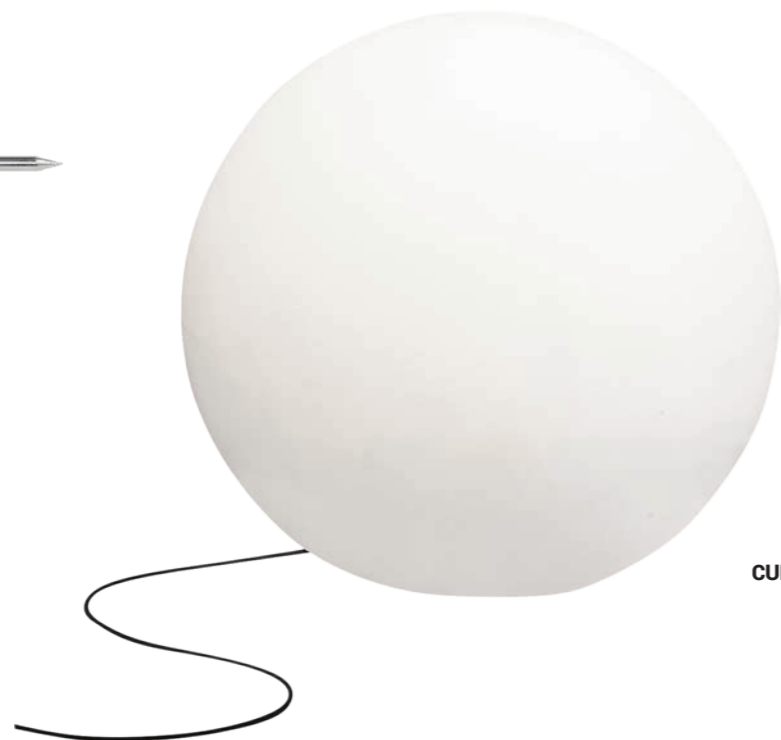

CUMULUS S 6976 WH

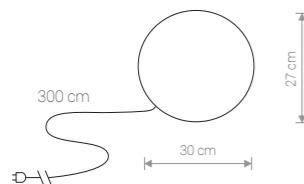

CUMULUS S

PE / PE / PE

6976 ○ WH

1×E27, max 40W

IP 44

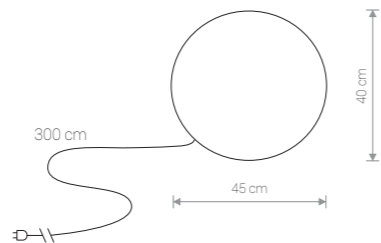

CUMULUS M

PE / PE / PE

6977 ○ WH

1×E27, max 60W

IP 44

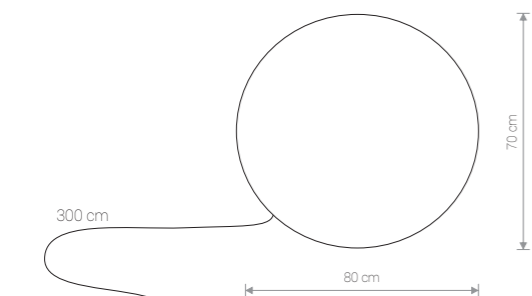

CUMULUS XL

PE / PE / PE

9714 ○ WH

1×E27, max 60W

IP 44

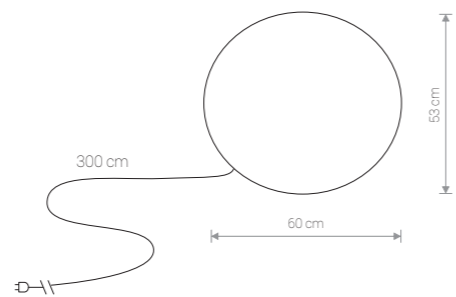

CUMULUS L

PE / PE / PE

6978 ○ WH

1×E27, max 60W

IP 44



CUMULUS M 6977 WH

CUMULUS S 6976 WH

CUMULUS L 6978 WH



FLOWERPOT S 9711 WH

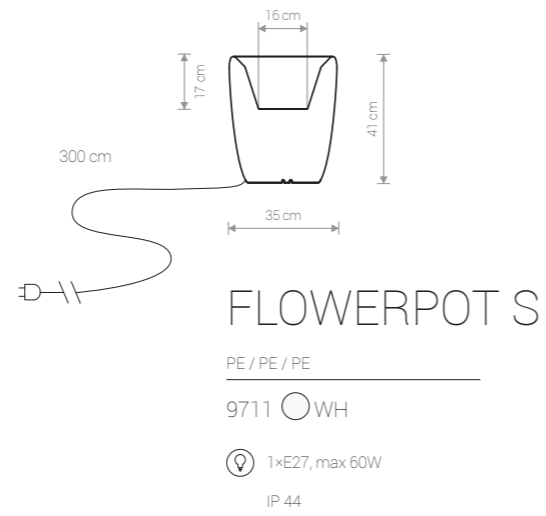

FLOWERPOT M 9712 WH

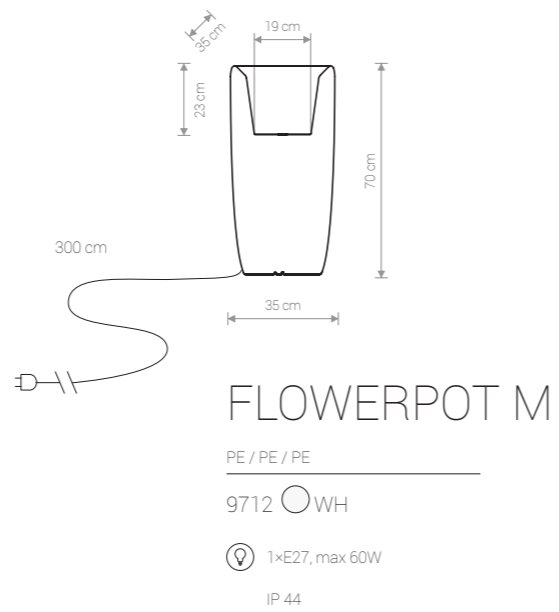

FLOWERPOT L 9713 WH

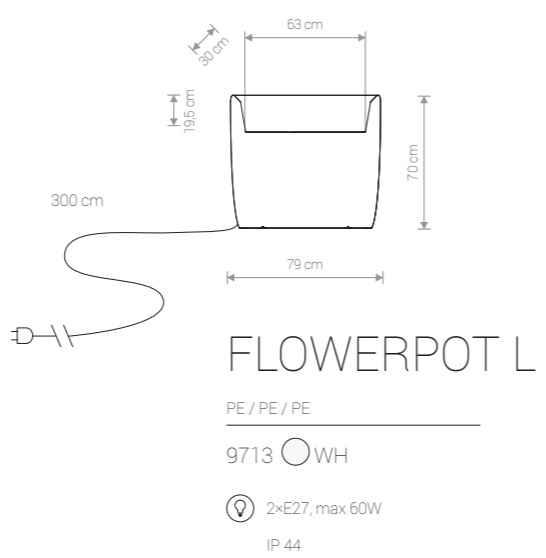



GALAXY 9246 WH/SI

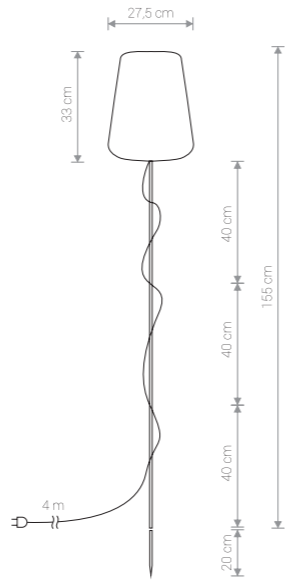

GALAXY

PE, INOX / PE, INOX / PE, INOX

9425 ○ WH/SI

1×E27, max 40W

IP 44

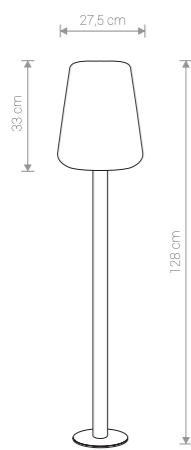

GALAXY

PE, stal lakierowana / PE, painted steel / PE, лакированная сталь

9246 ○ WH/GR

1×E27, max 40W

IP 65



STAR 9426 WH

STAR 9426 WH

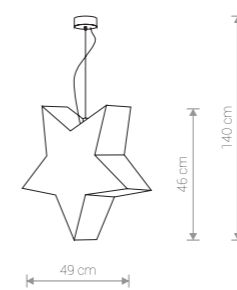

STAR

PE / PE / PE

9418 ○ WH

1×E27, max 40W

IP 65

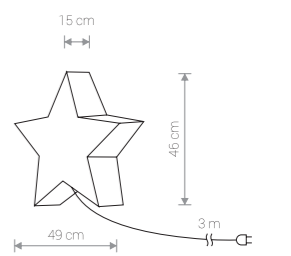

STAR

PE / PE / PE

9426 ○ WH

1×E27, max 40W

IP 44



outdoor



SOUL 9568 WH

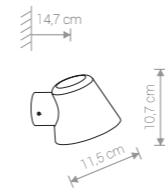

SOUL

aluminium, szkło / aluminium, glass /
алюминий, стекло

9555 ● GR 9556 ○ WH

ⓧ 1×GU10, max 35W
IP 44



SOUL 9556 WH

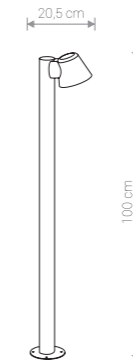

SOUL

aluminium, szkło / aluminium, glass /
алюминий, стекло

9557 ● GR 9558 ○ WH

ⓧ 1×GU10, max 35W
IP 44



SOUL 9560 GR

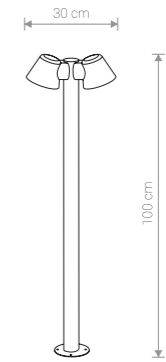

SOUL

aluminium, szkło / aluminium, glass /
алюминий, стекло

9560 ● GR

ⓧ 2×GU10, max 35W
IP 44

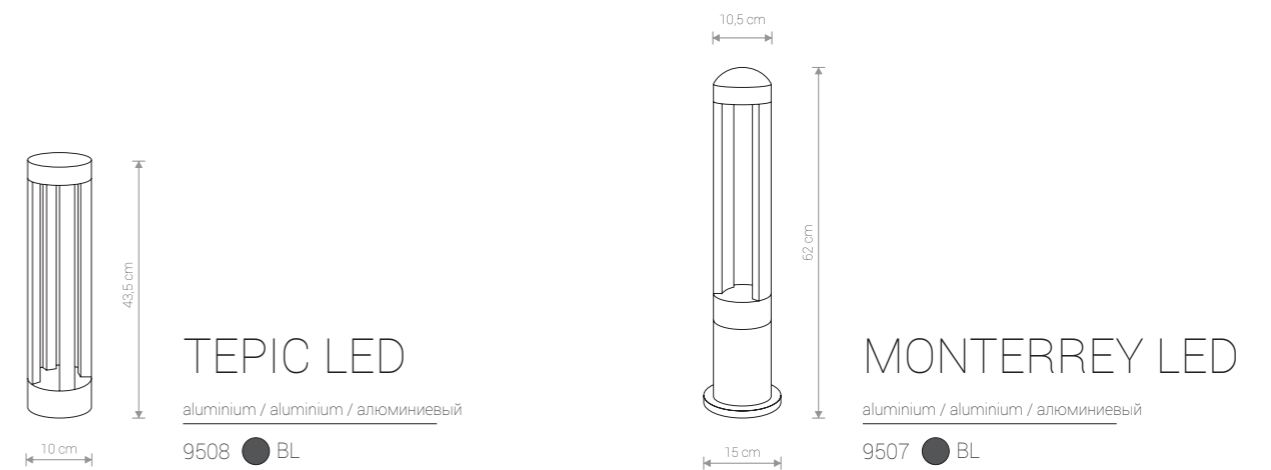

Item No.	POWER	COLOUR TEMP.	LUMINOUS FLUX	BEAM ANGLE	COLOUR RENDERING INDEX (CRI _a)	SAFETY TYPE	INPUT	POWER FACTOR	INGRES PROTECTION	LIFETIME
9508	9W LED	3000K	395 lm	31°	80	⊕	~220-240V, 50 Hz	0,85	IP 54	10 000 h
9507	9W LED	3000K	410 lm	39°	80	⊕	~220-240V, 50 Hz	0,85	IP 54	10 000 h

MEKONG 4418 GR

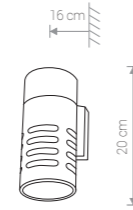

MEKONG

aluminium, szkło / aluminium, glass /
аллюминий, стекло

4418 ● GR

1×E27, max 18W

IP 42

MISTRAL

aluminium, PC / aluminium, PC /
аллюминий, PC

4390 ● GR

1×E27, max 23W

IP 44



MISTRAL 4390 GR

MISTRAL 3393 GR



MISTRAL

aluminium, PC / aluminium, PC /
аллюминий, PC

3393 ● GR

1×E27, max 23W

IP 44

MISTRAL 3394 GR

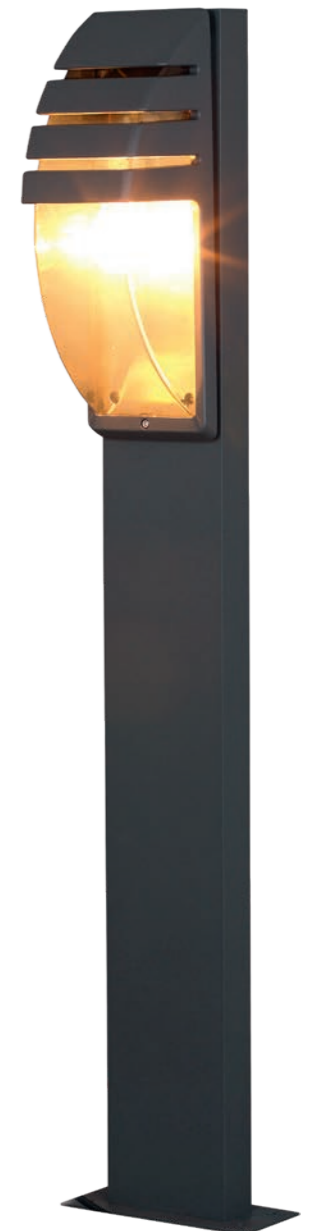

MEKONG 4420 GR

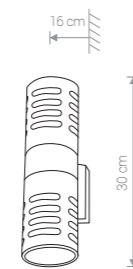

MEKONG

aluminium, szkło / aluminium, glass /
аллюминий, стекло

4420 ● GR

2×E27, max 18W

IP 42

MISTRAL

aluminium, PC / aluminium, PC /
аллюминий, PC

3393 ● GR

1×E27, max 23W

IP 44

MEKONG 4698 GR

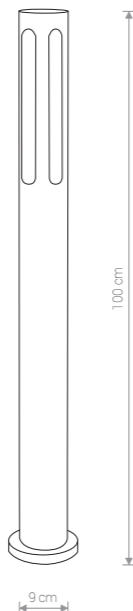

MEKONG

aluminium, szkło / aluminium, glass /
аллюминий, стекло

4698 ● GR

1×E27, max 18W

IP 42

MISTRAL

aluminium, PC / aluminium, PC /
аллюминий, PC

3394 ● GR

1×E27, max 23W

IP 44

LHOTSE LED 4447 GR

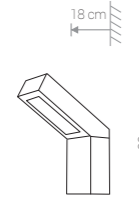

LHOTSE LED

aluminium, PC / aluminium, PC / алюминий, PC

4447 ● GR



LHOTSE LED 4448 GR

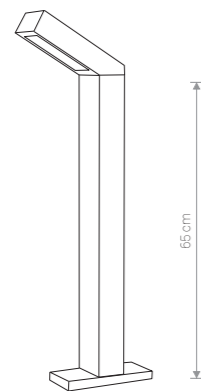

LHOTSE LED

aluminium, PC / aluminium, PC / алюминий, PC

4448 ● GR

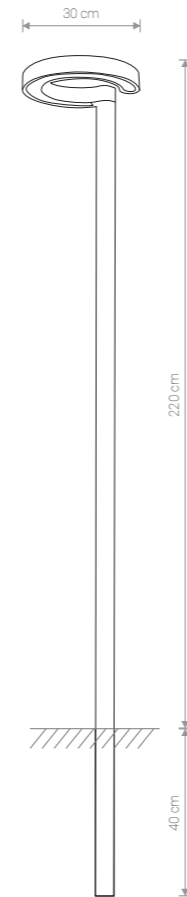
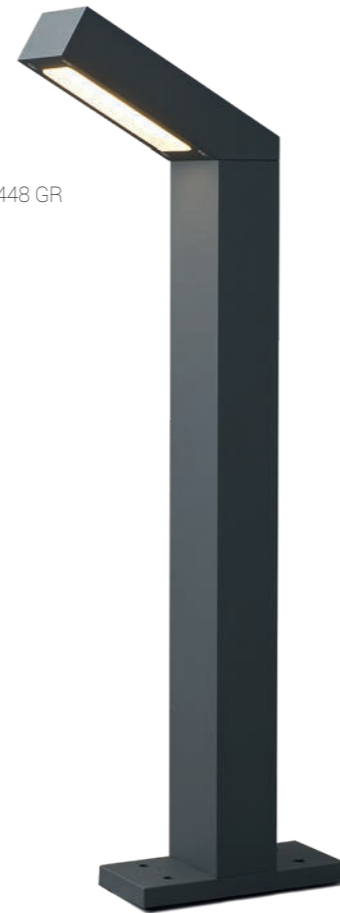

POLE LED

aluminium, PC / aluminium, PC / алюминий, PC

9185 ● GR



POLE LED 9185 GR

Item No.	POWER	COLOUR TEMP.	LUMINOUS FLUX	BEAM ANGLE	COLOUR RENDERING INDEX (CRI ₂)	SAFETY TYPE	INPUT	POWER FACTOR	INGRES PROTECTION	LIFETIME
4447	3x3W LED	3000K	169 lm	72°	80	⊕	~220-240V, 50 Hz	0,79	IP 54	10 000 h
4448	3x3W LED	3000K	169 lm	72°	80	⊕	~220-240V, 50 Hz	0,79	IP 54	10 000 h
9185	12x2W LED	3000K	950 lm	54°	81	⊕	~220-240V, 50 Hz	0,94	IP 54	30 000 h



PATHWAY LED 9252 BL

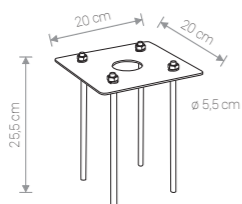

PATHWAY FOUNDATION KIT

stal ocynkowana / galvanized steel / оцинкованная сталь

8795 ○ SI

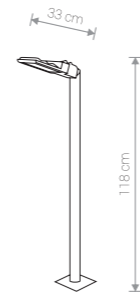

PATHWAY LED

aluminium, stal lakierowana / aluminium, painted steel / алюминий, лакированная сталь

9420 ● BL



PATHWAY LED

aluminium, stal lakierowana / aluminium, painted steel / алюминий, лакированная сталь

9252 ● BL

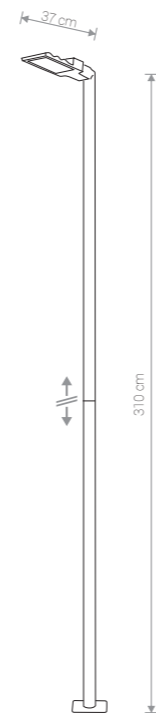

PATHWAY LED

aluminium, stal lakierowana / aluminium, painted steel / алюминий, лакированная сталь

9125 ● BL



PATHWAY LED 9425 BL

PATHWAY LED 9420 BL

Item No.	POWER	COLOUR TEMP.	LUMINOUS FLUX	BEAM ANGLE	COLOUR RENDERING INDEX (CRI >=)	INPUT	SAFETY TYPE	POWER FACTOR	INGRESS PROTECTION	LIFETIME
9420, 9252	24W LED	3000K	2200 lm	100°	80	~220-240V, 50Hz	⊕	0,9	IP 44	30 000 h
9125	36W LED	3000K	3600 lm	100°	80	~220-240V, 50Hz	⊕	0,9	IP 44	30 000 h

SPIKE LED 9098 BL

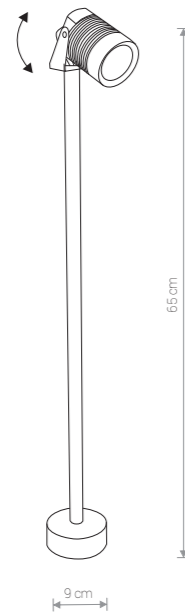

SPIKE LED

aluminium / aluminium / алюминий

9098 ● BL

SPIKE LED 9100 BL

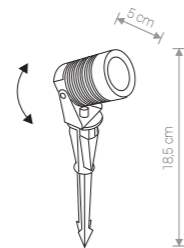

SPIKE LED

aluminium / aluminium / алюминий

9100 ● BL

SPIKE LED 9101 BL

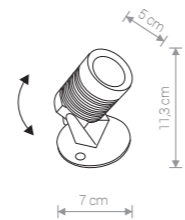

SPIKE LED

aluminium / aluminium / алюминий

9101 ● BL



THIKA LED 9120 BL

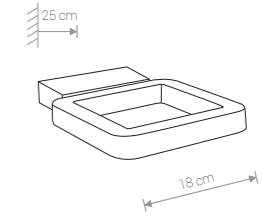

THIKA LED

aluminium, szkło / aluminium, glass / алюминий, стекло

9120 ● BL



THIKA LED 9121 BL

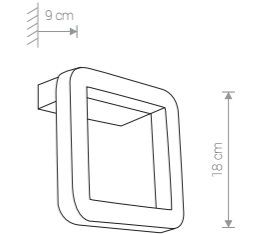

THIKA LED

aluminium, szkło / aluminium, glass / алюминий, стекло

9121 ● BL



THIKA LED 9118 BL

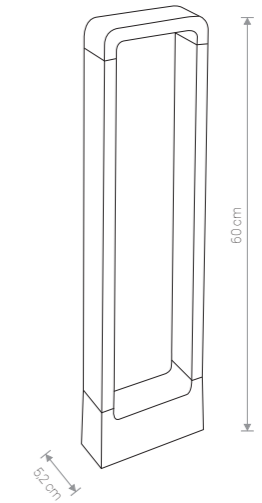

THIKA LED

aluminium, szkło / aluminium, glass / алюминий, стекло

9118 ● BL

Item No.	POWER	COLOUR TEMP.	LUMINOUS FLUX	BEAM ANGLE	COLOUR RENDERING INDEX (CRI >)	INPUT	SAFETY TYPE	POWER FACTOR	INGRESS PROTECTION	LIFETIME
9101	3W LED	3000K	115 lm	35°	80	~220-240V, 50Hz	⊕	0,55	IP 54	10 000 h
9100	3W LED	3000K	115 lm	35°	80	~220-240V, 50Hz	⊕	0,55	IP 54	10 000 h
9098	3W LED	3000K	115 lm	35°	80	~220-240V, 50Hz	⊕	0,55	IP 54	10 000 h

Item No.	POWER	COLOUR TEMP.	LUMINOUS FLUX	BEAM ANGLE	COLOUR RENDERING INDEX (CRI >)	INPUT	SAFETY TYPE	POWER FACTOR	INGRESS PROTECTION	LIFETIME
9121	10W LED	3000K	996 lm	110°	80	~220-240V, 50Hz	⊕	0,9	IP 54	20 000 h
9120	15W LED	3000K	1035 lm	110°	80	~220-240V, 50Hz	⊕	0,9	IP 54	20 000 h
9118	9W LED	3000K	520 lm	39°	80	~220-240V, 50Hz	⊕	0,5	IP 54	20 000 h

RIO 4424 BL

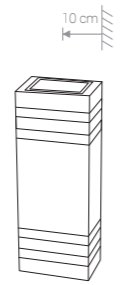
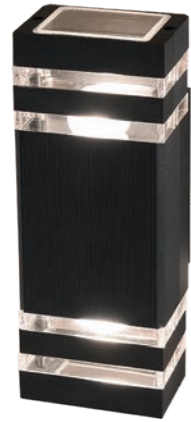

RIO

aluminium, PC / aluminium, PC / алюминий, PC

4424 ● BL

2×E27, max 40W

IP 54

RIO SENSOR 7017 BL



RIO

aluminium, PC / aluminium, PC / алюминий, PC

4423 ● BL

1×E27, max 40W

IP 54

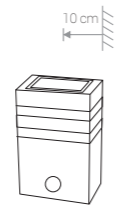

RIO SENSOR

aluminium, PC / aluminium, PC / алюминий, PC

7017 ● BL

1×E27, max 40W

IP 54

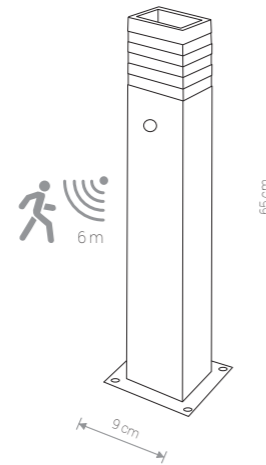

RIO SENSOR

aluminium, PC / aluminium, PC / алюминий, PC

9097 ● BL

1×E27, max 40W

IP 54

RIO SENSOR 9097 BL

SIERRA 4422 BL

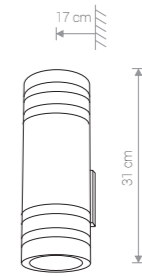

SIERRA

aluminium, PC / aluminium, PC / алюминий, PC

4422 ● BL

2×E27, max 40W

IP 54

SIERRA 4421 BL

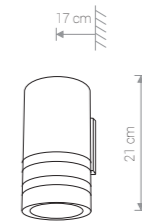

SIERRA

aluminium, PC / aluminium, PC / алюминий, PC

4421 ● BL

1×E27, max 40W

IP 54



OIR 9158 BL

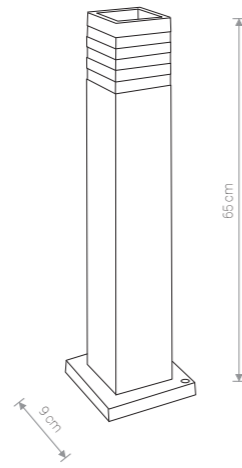

OIR

aluminium, PC / aluminium, PC /
алюминий, PC

9158 ● BL

1×E27, max 40W

IP 44



SIROCCO 3396 GR



SIROCCO

aluminium, szkło / aluminium, glass /
алюминий, стекло

3396 ● GR

1×E27, max 40W

IP 44



NORIN 4446 GR

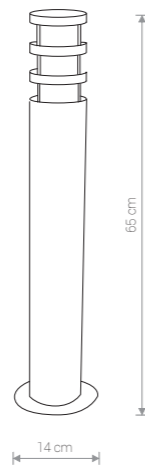

NORIN

aluminium, szkło / aluminium, glass /
алюминий, стекло

4446 ● GR

1×E27, max 20W

IP 44



HORN 4906 BR



HORN

aluminium, szkło / aluminium, glass /
алюминий, стекло

4906 ● BR

1×E27, max 20W

IP 44



NEGRO 4426 GY

NEGRO 4425 GY

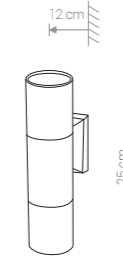

NEGRO

aluminium, szkło / aluminium, glass /
алюминий, стекло

4426 ● GY

2×GU10, max 35W

IP 54

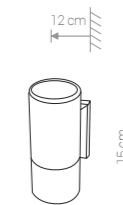

NEGRO

aluminium, szkło / aluminium, glass /
алюминий, стекло

4425 ● GY

1×GU10, max 35W

IP 54

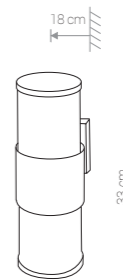

TORRENS

aluminium, szkło / aluminium, glass /
алюминий, стекло

4431 ● GY

2×E27, max 40W

IP 54

TORRENS 4431 GY



ROCK 3406 GR

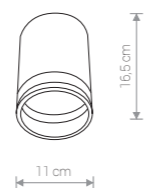

ROCK

aluminium, PC / aluminium, PC / алюминий, PC

3406 ● GR

1×E27, max 60W

IP 44



FOG 3403 GR



FOG

aluminium, szkło / aluminium, glass / алюминий, стекло

3403 ● GR

1×E27, max 60W

IP 44



ROCK 3405 GR

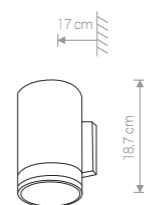

ROCK

aluminium, PC / aluminium, PC / алюминий, PC

3405 ● GR

1×E27, max 60W

IP 44



FOG 3402 GR



FOG

aluminium, szkło / aluminium, glass / алюминий, стекло

3402 ● GR

1×E27, max 60W

IP 44



ROCK 3407 GR

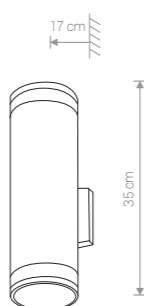

ROCK

aluminium, PC / aluminium, PC / алюминий, PC

3407 ● GR

2×E27, max 60W

IP 44



FOG 3404 GR

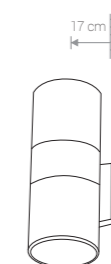

FOG

aluminium, szkło / aluminium, glass / алюминий, стекло

3404 ● GR

2×E27, max 60W

IP 44



LENS 9113 WH



LENS 9112 BL

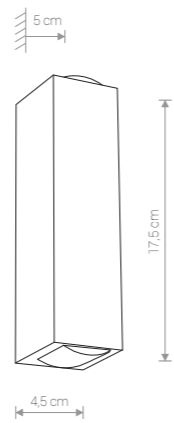

LENS LED

aluminium / aluminium / алюминий

9112 ● BL 9113 ○ WH

EDESA LED S 9110 BL

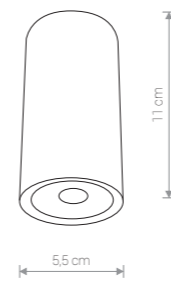

EDESA LED S

aluminium / aluminium / алюминий

9110 ● BL 9111 ○ WH



EDESA LED M 9108 WH

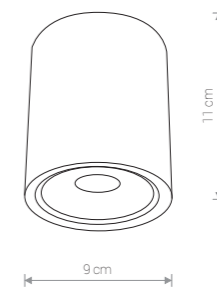

EDESA LED M

aluminium / aluminium / алюминий

9107 ● BL 9108 ○ WH

Item No.	POWER	COLOUR TEMP	LUMINOUS FLUX	BEAM ANGLE	COLOUR RENDERING INDEX (CRI >)	INPUT	SAFETY TYPE	POWER FACTOR	INGRESS PROTECTION	LIFETIME
9107, 9108	6W LED	3000K	370 lm	68°	80	~220-240V, 50Hz	⊕	0,55	IP 54	10 000 h
9110, 9111	3W LED	3000K	250 lm	52°	80	~220-240V, 50Hz	⊕	0,55	IP 54	10 000 h
9112, 9113	2×2W LED	3000K	110 lm	10°	80	~220-240V, 50Hz	⊕	0,55	IP 54	10 000 h



DONUT LED 9116 BL

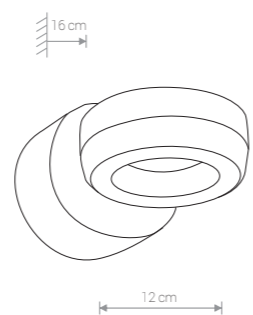

DONUT LED

aluminium / aluminium / алюминий

9116 ● BL



DONUT LED 9117 BL

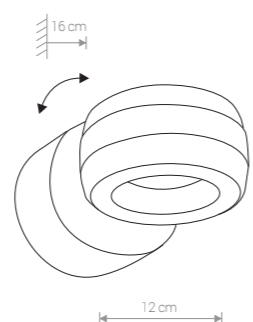

DONUT LED

aluminium / aluminium / алюминий

9117 ● BL



PATRAS LED 9115 BL

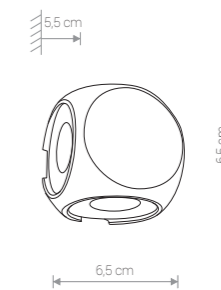

PATRAS LED

aluminium / aluminium / алюминий

9115 ● BL



ARGOS LED 9114 WH

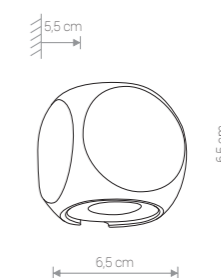

ARGOS LED

aluminium / aluminium / алюминий

9114 ○ WH

Item No.	POWER	COLOUR TEMP.	LUMINOUS FLUX	BEAM ANGLE	COLOUR RENDERING INDEX (CRI >)	INPUT	SAFETY TYPE	POWER FACTOR	INGRESS PROTECTION	LIFETIME
9116	6W LED	3000K	271 lm	110°	80	~200-240V, 50Hz	⊕	0,5	IP 54	20 000 h
9117	2x6W LED	3000K	636 lm	110°	80	~200-240V, 50Hz	⊕	0,5	IP 54	20 000 h

Item No.	POWER	COLOUR TEMP.	LUMINOUS FLUX	BEAM ANGLE	COLOUR RENDERING INDEX (CRI >)	INPUT	SAFETY TYPE	POWER FACTOR	INGRESS PROTECTION	LIFETIME
9115	4x1W LED	3000K	255 lm	38°	80	~220-240V, 50Hz	⊕	0,55	IP 54	10 000 h
9114	2x2W LED	3000K	280 lm	47°	80	~220-240V, 50Hz	⊕	0,55	IP 54	10 000 h

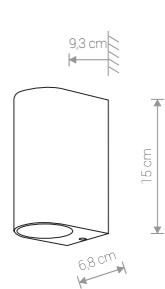

NICO

aluminium, szkło / aluminium, glass / алюминий, стекло

9517 ● GR

⚡ 2×GU10, max 10W
IP 54

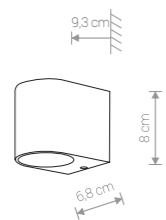

NICO

aluminium, szkło / aluminium, glass / алюминий, стекло

9518 ● GR

⚡ 1×GU10, max 10W
IP 54

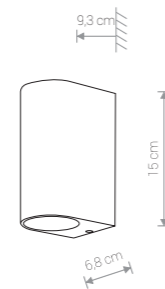

ARRIS

aluminium, szkło / aluminium, glass / алюминий, стекло

9515 ○ SI

⚡ 2×GU10, max 10W
IP 54

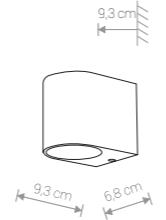

ARRIS

aluminium, szkło / aluminium, glass / алюминий, стекло

9516 ○ SI

⚡ 1×GU10, max 10W
IP 54

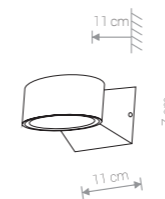

HANOI LED

aluminium / aluminium / алюминиевый

9512 ○ WH

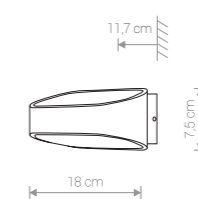

HAVANA LED

aluminium / aluminium / алюминиевый

9511 ○ WH

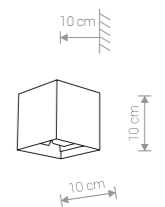

LIMA LED

aluminium / aluminium / алюминиевый

9510 ○ WH

Item No.	POWER	COLOUR TEMP.	LUMINOUS FLUX	BEAM ANGLE	COLOUR RENDERING INDEX (CRI)	SAFETY TYPE	INPUT	POWER FACTOR	INGRESS PROTECTION	LIFETIME
9512	6W LED	3000K	335 lm	92°	80	⊕	~220-240V, 50Hz	0,55	IP 54	10 000 h
9511	9W LED	3000K	430 lm	106°	80	⊕	~220-240V, 50Hz	0,55	IP 54	10 000 h
9510	6W LED	3000K	360 lm	97°	80	⊕	~220-240V, 50Hz	0,55	IP 54	10 000 h



PRIMM 9551 GR

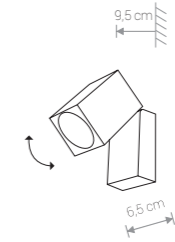

PRIMM

aluminium, szkło / aluminium, glass / алюминий, стекло

9551 ● GR

1xGU10, max 10W
IP 54



FALLON 9552 GR

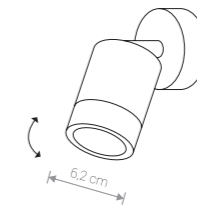

FALLON

aluminium, szkło / aluminium, glass / алюминий, стекло

9552 ● GR

1xGU10, max 10W
IP 54



LAMAR 9553 GR

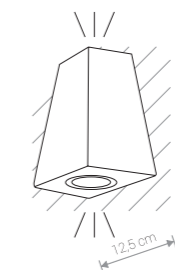

LAMAR

aluminium, szkło / aluminium, glass / алюминий, стекло

9553 ● GR

2xGU10, max 10W
IP 54



ASSOS 9124 BL

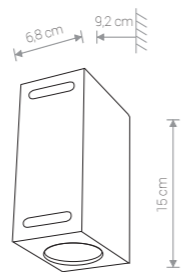

ASSOS

aluminium, szkło / aluminium, glass / алюминий, стекло

9124 ● BL

2×GU10, max 10W

IP 54



ASSOS 9123 BL

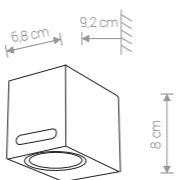

ASSOS

aluminium, szkło / aluminium, glass / алюминий, стекло

9123 ● BL

1×GU10, max 10W

IP 54



BRICK 3408 GR

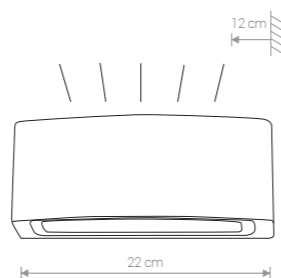

BRICK

aluminium, szkło / aluminium, glass / алюминий, стекло

3408 ● GR

1×E27, max 60W

IP 65



DISC LED 6910 BL

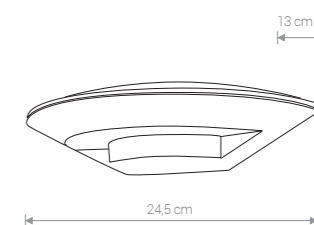

DISC LED

aluminium, PC / aluminium, PC / алюминий, PC

6910 ● BL



UNIT LED 9122 BL

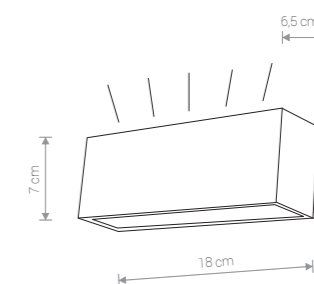

UNIT LED

aluminium / aluminium / алюминий

9122 ● BL

Item No.	POWER	COLOUR TEMP.	LUMINOUS FLUX	BEAM ANGLE	COLOUR RENDERING INDEX (CRI >)	INPUT	SAFETY TYPE	POWER FACTOR	INGRESS PROTECTION	LIFETIME
6910	4×1W LED	3000K	350 lm	67°	80	~220-240V, 50Hz	⊕	0,46	IP 44	10 000 h
9122	2×5W LED	3000K	727 lm	110°	80	~220-240V, 50Hz	⊕	0,89	IP 54	20 000 h



ZEM LED 4444 GR

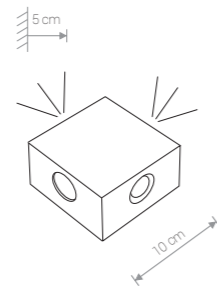

ZEM LED

aluminium, szkło / aluminium, glass / алюминий, стекло

4444 ● GR



SEMI LED 6775 GR

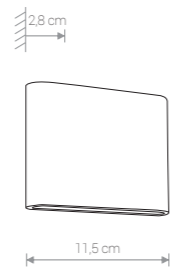

SEMI LED

aluminium, szkło / aluminium, glass / алюминий, стекло

6775 ● GR



MUNO LED 6776 GR

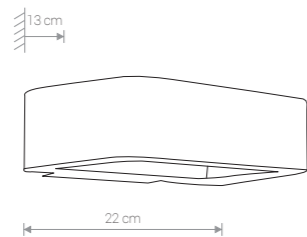

MUNO LED

aluminium / aluminium / алюминий

6776 ● GR



PEAK LED 4441 GR

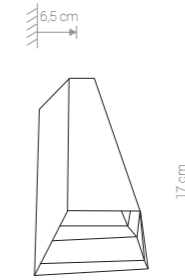

PEAK LED

aluminium, szkło / aluminium, glass / алюминий, стекло

4441 ● GR



DRAS LED 4442 GR

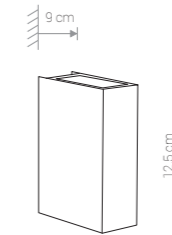

DRAS LED

aluminium, szkło / aluminium, glass / алюминий, стекло

4442 ● GR



KHUMBU 4443 GR

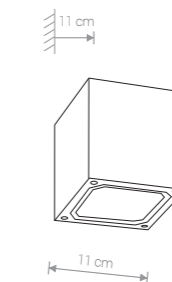

KHUMBU

aluminium, szkło / aluminium, glass / алюминий, стекло

4443 ● GR

Ⓢ 1xG9 max 40W

IP 44

Item No.	POWER	COLOUR TEMP	LUMINOUS FLUX	BEAM ANGLE	COLOUR RENDERING INDEX (CRI >)	INPUT	SAFETY TYPE	POWER FACTOR	INGRESS PROTECTION	INGRESS PROTECTION
4444	4x1W LED CREE ◀	3000K	321 lm	16°	80	~200-240V, 50Hz	⊕	0,89	IP 54	10 000 h
6775	36x0,2W LED CREE ◀	3000K	242 lm	120°	80	~220-240V, 50Hz	⊕	0,54	IP 54	8 000 h
6776	1x6W LED CREE ◀	3000K	242 lm	120°	80	~220-240V, 50Hz	⊕	0,54	IP 54	8 000 h

Item No.	POWER	COLOUR TEMP	LUMINOUS FLUX	BEAM ANGLE	COLOUR RENDERING INDEX (CRI >)	INPUT	SAFETY TYPE	POWER FACTOR	INGRESS PROTECTION	LIFETIME
4441	2x3W LED CREE ◀	3000K	62 lm	83°	80	~200-240V, 50Hz	⊕	0,91	IP 54	10 000 h
4442	2x3W LED CREE ◀	3000K	122 lm	65°	80	~200-240V, 50Hz	⊕	0,91	IP 54	10 000 h

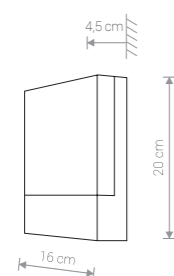
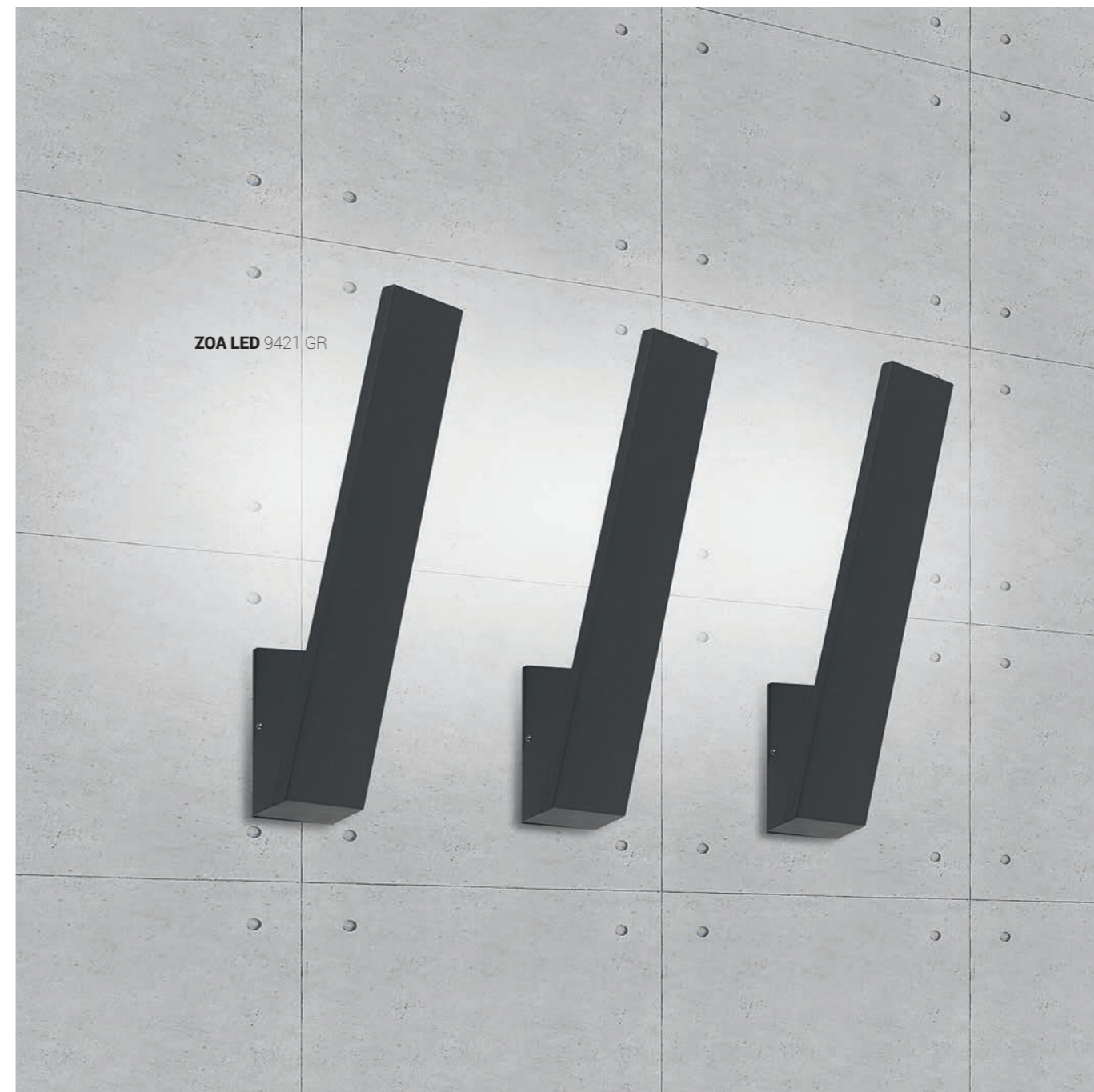

FLAT LED

aluminium, PC dyfuzor / aluminium, PC diffuser /
алюминий, PC диффузор

9422 ● GR

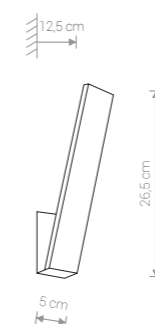

ZOA LED

aluminium, szkło / aluminium, glass / алюминий, стекло

9421 ● GR

ITEM NO	POWER	COLOUR TEMP.	LUMINOUS FLUX	BEAM ANGLE	COLOUR RENDERING INDEX (CRI ≥)	SAFETY TYPE	INPUT	POWER FACTOR	INGRESS PROTECTION	LIFETIME
9422	12W LED	3000K	350 lm	110°	81	⊕	~220-240V, 50Hz	0,9	IP 54	20 000 h
9421	10W LED	3000K	795 lm	110°	81	⊕	~220-240V, 50Hz	0,55	IP 54	20 000 h

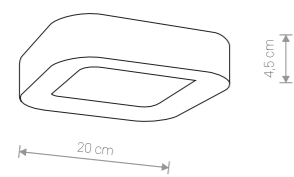

PUEBLA LED

aluminium, PC / aluminium, PC / алюминий, PC

9513 ● GR

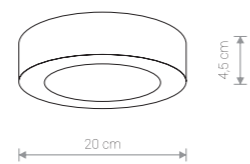

MERIDA LED

aluminium, PC / aluminium, PC / алюминий, PC

9514 ● GR

HEXA 9564 WH

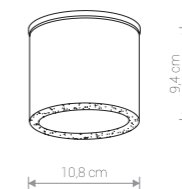

HEXA

aluminium, szkło / aluminium, glass / алюминий, стекло

9564 ○ WH 9565 ● GR

1×GU10, max 35W
IP 44

ITEM NO	POWER	COLOUR TEMP.	LUMINOUS FLUX	BEAM ANGLE	COLOUR RENDERING INDEX (CRI ≥)	SAFETY TYPE	INPUT	POWER FACTOR	INGRESS PROTECTION	LIFETIME
9513	12W LED	3000K	538 lm	110°	80	⊕	~220-240V, 50Hz	0,93	IP 54	20 000 h
9514	12W LED	3000K	538 lm	110°	80	⊕	~220-240V, 50Hz	0,93	IP 54	20 000 h



QUARTZ SENSOR 7016 BL

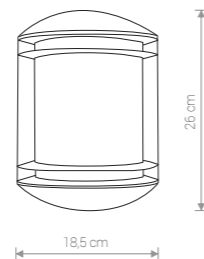

QUARTZ

aluminium, PC / aluminium, PC / алюминий, PC

3411 ● GR

1×E27, max 60W

IP 21



6 m

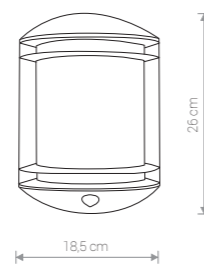

QUARTZ SENSOR

aluminium, PC / aluminium, PC / алюминий, PC

7016 ● BL

1×E27, max 60W

IP 21



INDUS 4440 GR

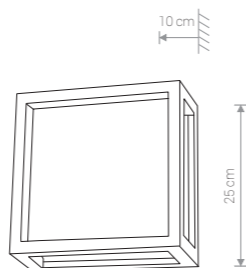

INDUS

aluminium, szkto / aluminium, glass / алюминий, стекло

4440 ● GR

2×E27, max 15W

IP 44



BUSH 3401 GR

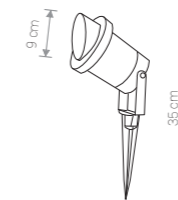

BUSH

aluminium, szkto / aluminium, glass / алюминий, стекло

3401 ● GR

1×GU10, max 35W

IP 65



BASALT 3412 GR

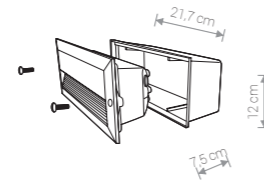

BASALT

aluminium, PC / aluminium, PC / алюминий, PC

3412 ● GR 4966 ○ SI

1×E14, max 60W

IP 44



ASSAM 4453 GR

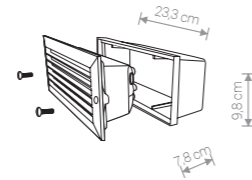

ASSAM

aluminium, szkło / aluminium, glass / алюминий, стекло

4453 ● GR

1×E27, max 18W

IP 65



INA 4907 GR

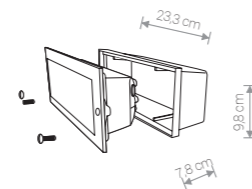

INA

aluminium, szkło / aluminium, glass / алюминий, стекло

4907 ● GR

1×E27, max 18W

IP 65

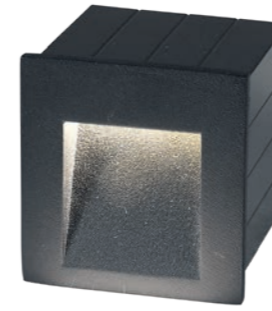

STEP LED 6907 GR

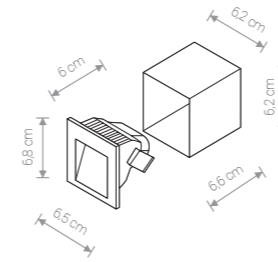

STEP LED

aluminium / aluminium / алюминий

6907 ● GR 6908 ○ WH

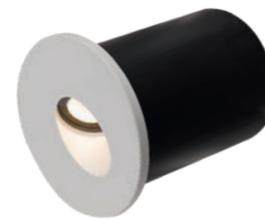

OIA LED 9103 WH

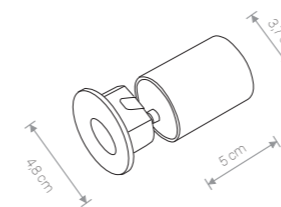

OIA LED

aluminium / aluminium / алюминий

9102 ● BL 9103 ○ WH



OIA LED 9102 BL

Item No.	POWER	COLOUR TEMP.	LUMINOUS FLUX	BEAM ANGLE	COLOUR RENDERING INDEX (CRI >)	INPUT	SAFETY TYPE	POWER FACTOR	INGRESS PROTECTION	LIFETIME
6908, 6907	1×3W LED	3000K	310 lm	92°	80	~220-240V, 50Hz	⊕	0,57	IP 44	10 000 h
9102, 9103	1W LED	3000K	45 lm	49°	80	~220-240V, 50Hz	⊕	0,55	IP 20	10 000 h



PICCO LED S 9106 SI

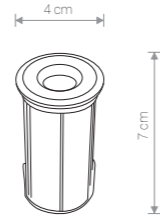

PICCO LED S

aluminium / aluminium / алюминий

9106 ○ SI



PAOLI 9554 SI

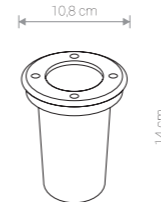

PAOLI

aluminium, szkło / aluminium, glass / алюминий, стекло

9554 ○ SI

⚡ 1xGU10, max 10W
IP 67



PICCO LED M 9105 SI

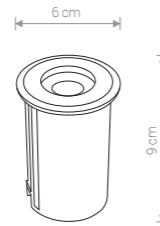

PICCO LED M

aluminium / aluminium / алюминий

9105 ○ SI



MON 4454 SI



MON

aluminium, szkło / aluminium, glass / алюминий, стекло

4454 ○ SI



PICCO LED L 9104 SI



PICCO LED L

aluminium / aluminium / алюминий

9104 ○ SI

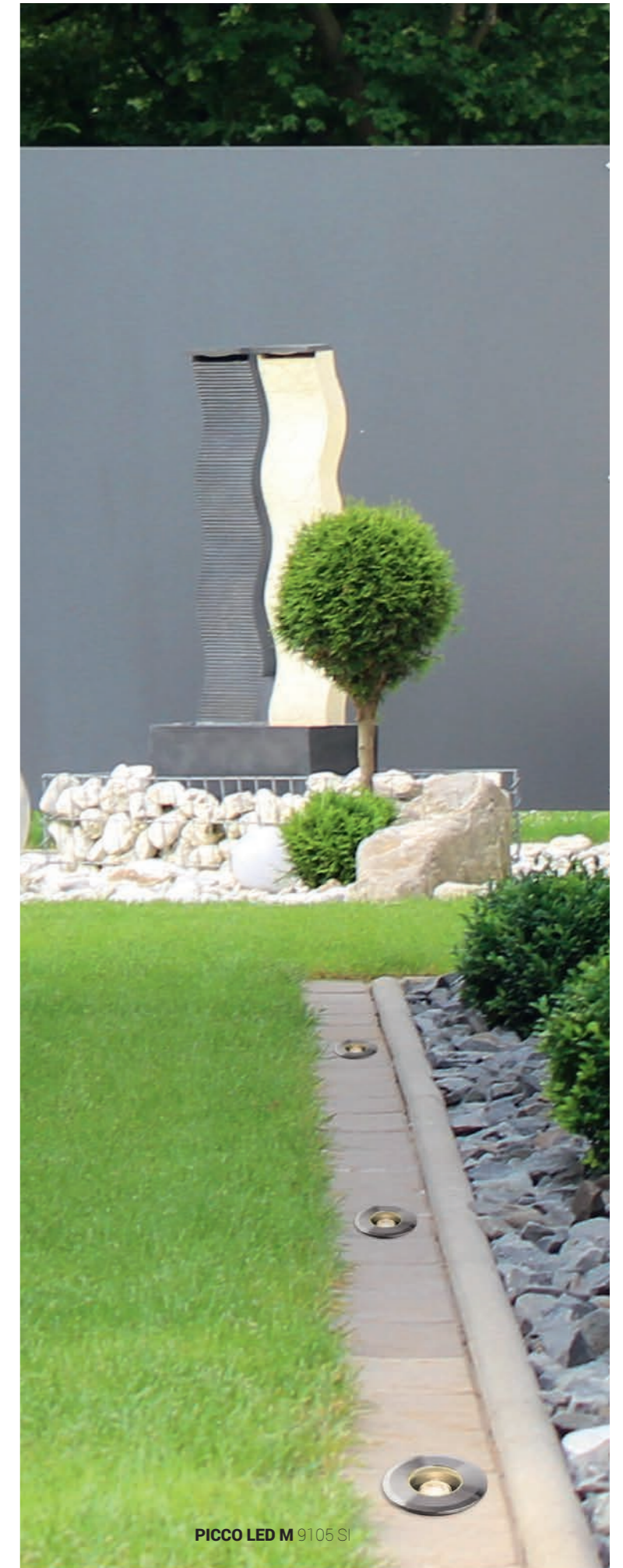

PICCO LED M 9105 SI

Item No.	POWER	COLOUR TEMP.	LUMINOUS FLUX	BEAM ANGLE	COLOUR RENDERING INDEX (CRI >)	INPUT	SAFETY TYPE	POWER FACTOR	INGRESS PROTECTION	INGRESS PROTECTION
9106	1x1W LED	3000K	47 lm	42°	80	~220-240V, 50Hz	⊕	0,55	IP 67	10 000 h
9105	1x1W LED	3000K	52 lm	51°	80	~220-240V, 50Hz	⊕	0,55	IP 67	10 000 h
9104	1x3W LED	3000K	130 lm	48°	80	~220-240V, 50Hz	⊕	0,55	IP 67	10 000 h
4454	1x1W LED CREE	3000K	68 lm	28°	80	~200-240V, 50Hz	⊕	0,42	IP 67	10 000 h



PROVENCE 9094 BL



MARINA 9096 BL

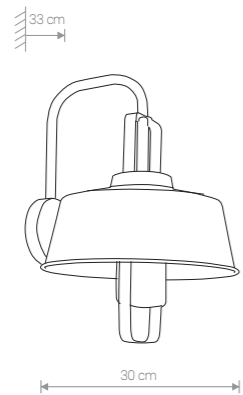

PROVENCE

aluminium, szkło / aluminium, glass / алюминий, стекло

9094 ● BL

1×E27, max 23W

IP 44

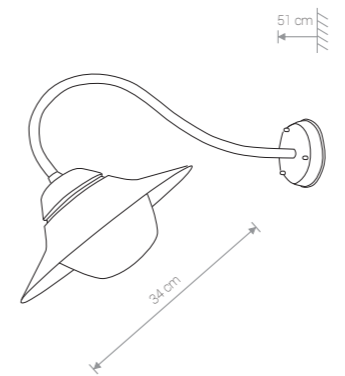

MARINA

aluminium, szkło / aluminium, glass / алюминий, стекло

9096 ● BL

1×E27, max 23W

IP 44



AMUR 4692 BR/CO

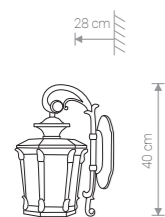

AMUR

aluminium, szkło / aluminium, glass /
аллюминий, стекло

4692 BR/CO

1×E27, max 60W

IP 23



AMUR 4693 BR/CO

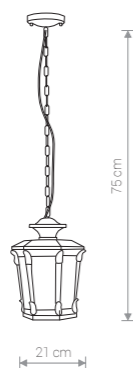

AMUR

aluminium, szkło / aluminium, glass /
аллюминий, стекло

4693 BR/CO

1×E27, max 60W

IP 23

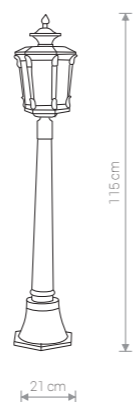

AMUR

aluminium, szkło / aluminium, glass /
аллюминий, стекло

4694 BR/CO

1×E27, max 60W

IP 44



TYBR 4684 BR/G

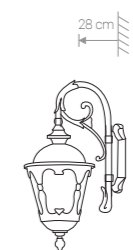

TYBR

aluminium, szkło / aluminium, glass /
аллюминий, стекло

4686 BR/G

1×E27, max 60W

IP 44



TYBR 4685 BR/G

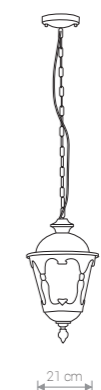

TYBR

aluminium, szkło / aluminium, glass /
аллюминий, стекло

4684 BR/G

1×E27, max 60W

IP 44

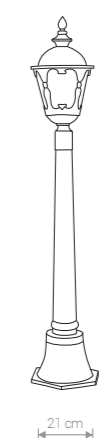

TYBR

aluminium, szkło / aluminium, glass /
аллюминий, стекло

4685 BR/G

1×E27, max 60W

IP 44



TAY 5294 BL



TAY 5292 BL

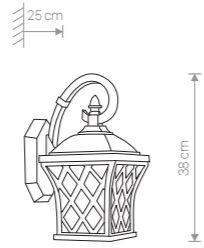

TAY

aluminium, szkło / aluminium, glass / алюминий, стекло

5292 ● BL

1×E27, max 60W

IP 23

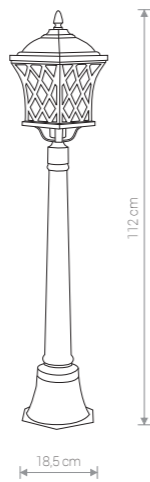

TAY

aluminium, szkło / aluminium, glass / алюминий, стекло

5294 ● BL

1×E27, max 60W

IP 23

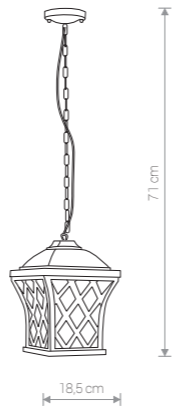

TAY

aluminium, szkło / aluminium, glass / алюминий, стекло

5293 ● BL

1×E27, max 60W

IP 23



SPEY 5290 BL

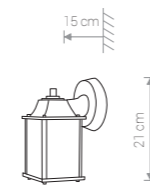

SPEY

aluminium, szkło / aluminium, glass / алюминий, стекло

5290 ● BL

1×E27, max 60W

IP 23



SPEY 5291 BL

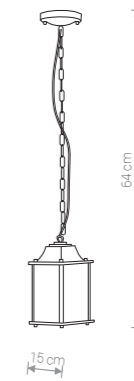

SPEY

aluminium, szkło / aluminium, glass / алюминий, стекло

5291 ● BL

1×E27, max 60W

IP 23



LANTERN 6911 BL/CO



LANTERN

aluminium, szkło / aluminium, glass / алюминий, стекло

6911 ● BL/CO

Ⓢ 1×E27, max 60W

IP 23



HORSE 4900 BR/G

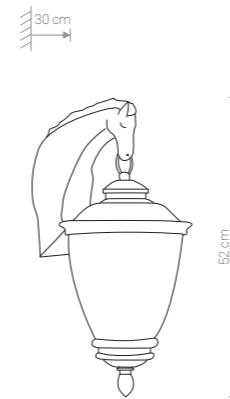

HORSE

żywica organiczna, szkło / polyresin, glass / органическая смола, стекло

4900 ● BR/G

Ⓢ 1×E27, max 60W

IP 44



HORSE 4901 BR/G

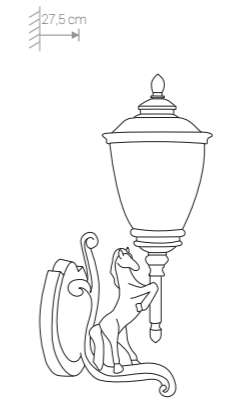

HORSE

żywica organiczna, szkło / polyresin, glass / органическая смола, стекло

4902 ● BR/G

Ⓢ 1×E27, max 60W

IP 44

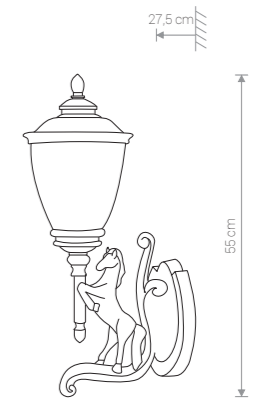

HORSE

żywica organiczna, szkło / polyresin, glass / органическая смола, стекло

4901 ● BR/G

Ⓢ 1×E27, max 60W

IP 44



DON 4687 BR

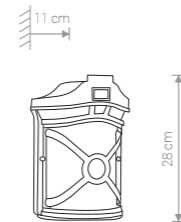

DON

aluminium, szkło / aluminium, glass / алюминий, стекло

4687 ● BR

Ⓢ 1×E27, max 60W

IP 44



accessories

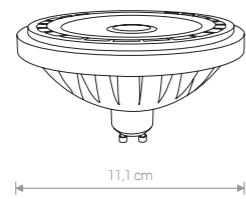

REFLECTOR GU10, ES111 LED COB, 15W

tworzywo sztuczne, aluminium / plastic, aluminium / пластик, алюминий

9831 ○ WH - 4000K

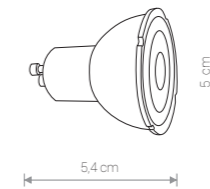

REFLECTOR GU10, R50, LED 7W

tworzywo sztuczne / plastic / пластик

9180 ○ WH - 3000K

9178 ○ WH - 4000K

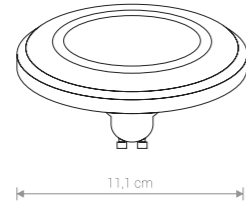

REFLECTOR LED, ES111 LENS, 9W

tworzywo sztuczne / plastic / пластик

9343 ● BL - 3000K 9345 ○ WH - 3000K

9213 ● BL - 4000K 9214 ○ WH - 4000K

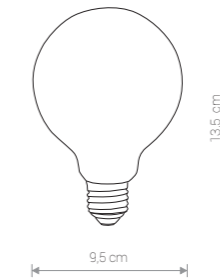

GLASS BALL BULB E27, LED 8W

szkło / glass / стекло

9177 ○ WH

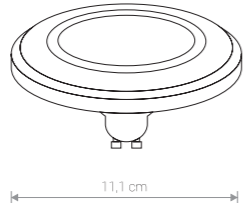

REFLECTOR LED, ES111 DIFFUSER, 9W

tworzywo sztuczne / plastic / пластик

9342 ● BL - 3000K 9344 ○ WH - 3000K

9211 ● BL - 4000K 9212 ○ WH - 4000K

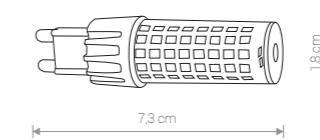

G9 BULB LED 7W

ceramika, PC / ceramic housing, PC / PC

9197 ○ WH



REFLECTOR GU10, ES111, LED COB, 12W

tworzywo sztuczne, aluminium / plastic, aluminium / пластик, алюминий

9181 ● CH - 3000K

9182 ● CH - 4000K

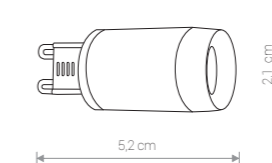

G9 BULB LED LENS 3W

ceramika, PC / ceramic housing, PC / PC

9173 ○ WH

Item No.	POWER	COLOUR TEMP.	LUMINOUS FLUX	BEAM ANGLE	COLOUR RENDERING INDEX (CRI >)	INPUT	SAFETY TYPE	POWER FACTOR	LIFETIME
9343, 9345	9W	3000K	810 lm	30°	80	~220-240V, 50Hz	□	> 0,5	25 000 h
9213, 9214	9W	4000K	800 lm	30°	80	~220-240V, 50Hz	□	> 0,5	25 000 h
9342, 9344	9W	3000K	810 lm	120°	80	~220-240V, 50Hz	□	> 0,5	25 000 h
9211, 9212	9W	4000K	700 lm	120°	80	~220-240V, 50Hz	□	> 0,5	25 000 h
9831	15W	4000K	1100 lm	36°	80	~220-240V, 50Hz	□	> 0,5	25 000 h

Item No.	POWER	COLOUR TEMP.	LUMINOUS FLUX	BEAM ANGLE	COLOUR RENDERING INDEX (CRI >)	INPUT	SAFETY TYPE	POWER FACTOR	LIFETIME
9180	7W LED	3000K	500 lm	36°	80	~220-240V, 50Hz	□	0,5	25 000 h
9178	7W LED	4000K	500 lm	36°	80	~220-240V, 50Hz	□	0,5	25 000 h
9181	12W LED	3000K	560 lm	24°	80	~220-240V, 50Hz	□	0,5	25 000 h
9182	12W LED	4000K	560 lm	24°	80	~220-240V, 50Hz	□	0,5	25 000 h
9177	8W LED	3000K	800 lm	360°	80	~220-240V, 50Hz	□	0,5	25 000 h
9197	7W LED	3000K	700 lm	360°	80	~220-240V, 50Hz	□	0,5	25 000 h
9173	3W LED	3000K	280 lm	120°	80	~220-240V, 50Hz	□	0,5	25 000 h



LED TUBE T8 11W

szkło / glass / стекло

9253 ○ WH



LED TUBE T8 16W

szkło / glass / стекло

9254 ○ WH



LED TUBE T8 22W

szkło / glass / стекло

9255 ○ WH

Item No.	POWER	COLOUR TEMP.	LEDS	LUMINOUS FLUX	BEAM ANGLE	COLOUR RENDERING INDEX (CRI >)	INPUT	POWER FACTOR	LIFETIME
9253	11W LED	3000K	SMD2835	950-1000 lm	200°	80	~230V, 50Hz	>0,9	25 000 h
9254	16W LED	3000K	SMD2835	1400-1500 lm	200°	80	~230V, 50Hz	>0,9	25 000 h
9255	22W LED	3000K	SMD2835	2000-2100 lm	200°	80	~230V, 50Hz	>0,9	25 000 h

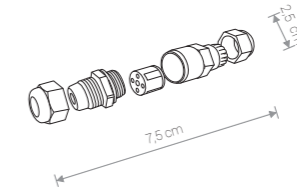

IP68 WATERPROOF CABLE CONNECTOR

tworzywo sztuczne / plastic / пластик

8845 ● BL

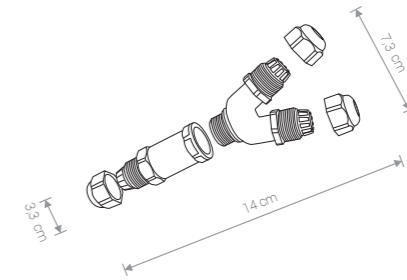

IP68 „Y” WATERPROOF CABLE CONNECTOR

tworzywo sztuczne / plastic / пластик

8846 ● BL

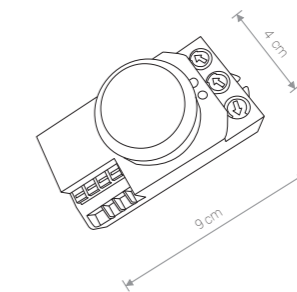

MICROWAVE SENSOR

tworzywo sztuczne / plastic / пластик

8821 ○ WH

reach: 3-10 m (radil.) adjustable
time setting: 8 sec to 12 min
ligh control: 2-2000 LUX
power supply: 230V, 50 Hz



DUPLEX

PC, aluminium / PC, aluminium / PC, алюминий

9341 ○ WH

⚡ 1×E27 / 2×E27, max 40W

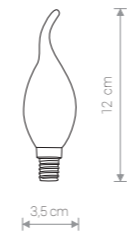

DECORATIVE
BULB
szkło / glass / стекло

5021
E14, 40W



VINTAGE LED
BULB
szkło / glass / стекло

9793
E14

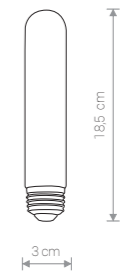

VINTAGE LED
BULB
szkło / glass / стекло

9795
E27



VINTAGE LED
BULB
szkło / glass / стекло

9796
E27



VINTAGE LED
BULB
szkło / glass / стекло

9794
E27



VINTAGE LED
BULB
szkło / glass / стекло

9797
E27

Item No.	POWER	COLOUR TEMP.	LUMINOUS FLUX	BEAM ANGLE	COLOUR RENDERING INDEX (CRI >)	INPUT	REPLACEMENT	SWITCH CYCLES ON/OFF	LIFETIME
9793	4W LED	2200K	360 lm	360°	80	~230V, 50Hz	4W LED=35W	x 15 000	15 000 h
9796	4W LED	2200K	360 lm	360°	80	~230V, 50Hz	4W LED=35W	x 15 000	15 000 h
9795	4W LED	2200K	360 lm	360°	80	~230V, 50Hz	4W LED=35W	x 15 000	15 000 h
9794	4W LED	2200K	360 lm	360°	80	~2230V, 50Hz	4W LED=35W	x 15 000	15 000 h
9797	4W LED	2200K	360 lm	360°	80	~230V, 50Hz	4W LED=35W	x 15 000	15 000 h

ALFABETYCZNY SPIS TREŚCI / ALPHABETICAL INDEX

A	BIG BOY	247	CROCO	139	EYE SUPER B	57
A LED	BIO	180	CROSS	271	EYE SUPER C	58
ABI L	BIOWAY	181	CUBE	238	EYE TONE	285
ABI M	BIT M	287	CUBOID	272	F	
ABI S	BIT S	287	CUMULUS CUBE L	401	FACTORY	82
ACROSS	BOAT	145	CUMULUS CUBE M	401	FALLON	437
AGADIR	BOLD	123	CUMULUS L	403	FIORD	38
AGNES ROUND LED	BOWL L	97	CUMULUS M	403	FISHING ROD	165
AGNES SQUARE LED	BOWL M	97	CUMULUS S	403	FIXING SET	267
AIDA	BOX ES111	293	CUMULUS XL	404	FLAM	158
ALANYA	BOX LED	290	CYCLON	74	FLAT LED	442
ALASKA	BRAZOS	389	D		FLEX	112
ALEHANDRO 100	BRICK	438	DAKAR	338	FLEX SHADE	166
ALEHANDRO 35	BRYCE L	66	DECORATIVE BULB	467	FLORES	322
ALEHANDRO 45	BRYCE M	66	DEGAS LED M	241	FLOWERPOT L	406
ALEHANDRO 55	BRYCE S	66	DEGAS LED S	241	FLOWERPOT M	406
ALEHANDRO 70	BUBBLE	100	DIAMOND	99	FLOWERPOT S	406
ALEHANDRO LED 100	BULLET	44	DISC LED	439	FLOWERS	368
ALICE	BUSH	447	DON	458	FOG	429
ALLAN	C		DONUT LED	432	FOGGIA	215
AMALFI	CABLE BLACK/COOPER	104	DOT	297	FORM L	130
AMARA	CAGE	22	DOVER	178	FORM M	130
AMUR	CAMERON	140	DOWNLIGHT ES111	293	FRASER LED	388
ARCH	CAMILLA	20	DOWNLIGHT LED	299	FRESCO	328
ARENA	CANALINA CLASSIC	351	DOWNLIGHT M	286	G	
ARENA LED	CANALINA ZEBRA	351	DOWNLIGHT S	286	G9 BULB LED 7W	463
ARENA SENSOR	CARSON	291	DRAS LED	441	G9 BULB LED LENS 3W	463
ARES	CAYO	386	DUPLEX	465	GALAXY	408
ARGOS LED	CEILING COB	301	E		GAP	282
ARRIS	CEILING LED	298	EDESA LED M	431	GARDA	397
ASSAM	CELTIC	390	EDESA LED S	431	GARRET	84
ASSOS	CLASSIC	346	EDITH	162	GAUDI LED M	242
ATTYKA	COBA	188	EGG L	9	GAUDI LED S	242
AVEIRO	COLVILLE	278	EGG M	9	GEOMETRIC	117
AWINION	COMIC BOOK	365	EGG XL	8	GESS LED	236
AXIS	CONNECTOR IP68 „Y” WATERPROOF	465	EOL	300	GIPSY ŁUK L	127
B	CONNECTOR IP68 WATERPROOF	465	EYE FIT	277	GIPSY ŁUK S	127
BALI	CONO CLASSIC	349	EYE FLEX	54	GIPSY MOON S	127
BALL	CONTRASTAMPO	348	EYE FLEX S	54	GIPSY PROSTOKĄT L	126
BALTIC	CORA	318	EYE L	48	GIPSY PROSTOKĄT M	126
BARON	CORSICA	215	EYE M	48	GIPSY PROSTOKĄT S	126
BASALT	COSMO S	248	EYE MOD	296	GITARRA	373
BASSA LED	CRAFT	73	EYE S	49	GLASS BALL BULB E27, LED 8W	463
BERGEN	CRANE	198	EYE SPOT	274	GLOBE	204
	CRATE	32	EYE SUPER	58	GOYA LED	242
			EYE SUPER A	57	GROOVE	283

GSTAR	19
GUJAR	373
GYPSUM	118

H

H LED	223
HAGA	232
HALL LED	231
HANOI LED	435
HARMONY	76
HAVANA LED	435
HAWK	169
HEART	362
HELIOS	300
HEMISPHERE CEILING	95
HEMISPHERE CRACKS L	90
HEMISPHERE CRACKS S	90
HEMISPHERE HIT L	96
HEMISPHERE HIT S	96
HEMISPHERE L	92
HEMISPHERE RUST L	90
HEMISPHERE RUST S	90
HEMISPHERE S	93
HEXA	445
HIGH-BAY	81
HIRO	349
HONEY	366
HORN	426
HORSE	459
HOTEL	160
HOTEL LED	161
HOTEL PLUS	163

I

IBIZA SPHERE	212
IKA	182
IKA A	182
IKA C	182
IKA D	182
IMBRIA	60
INA	448
INDUS	446
INDUSTRIAL L	79
INDUSTRIAL M	79
INDUSTRIAL S	78
IRIS LED 7W	280

K

KAGERA LED L	383
KAGERA LED M	383
KAREN	20
KASAI	243
KASAI SENSOR	243
KATERINA	216
KEAL GOLD S	239
KENDO	356
KHUMBU	441
KORYNT	308
KYOTO	354
KYOTO SHINE	355

L

LAGUNA	132
LAMAR	437
LANTERN	458
LASER	46
LAVA L	115
LAVA S	115
LED TUBE T8 11W	464
LED TUBE T8 16W	464
LED TUBE T8 22W	464
LENS LED	430
LHOTSE LED	418
LIA LED	236
LIMA LED	435
LIRA	324
LOFT	86
LUKSOR L	13
LUKSOR PLUS L	14
LUKSOR PLUS S	14
LUKSOR S	13
LUX MAT	345

M

MAKEUP LED	385
MALAKKA LED	393
MALMO	233
MALWI	376
MANUFACTURE	42
MARGARET	326
MARINA	453
MEKNES	23
MEKONG	416
MERIDA LED	444

MERSEY	23
MICROWAVE SENSOR	465
MIKI	316
MILL	35
MILTON	390
MINIMAL	174
MIRROR LED	382
MIST	131
MISTRAL	417
MOD	294
MOD PLUS	295
MODENA	214
MON	451
MONACO	196
MONET LED M	241
MONET LED S	241
MONTERREY LED	415
MOSS	159
MUNO LED	440
MUSE L	129
MUSE M	129

N

NAGANO	357
NARWIK	233
NEGRO	427
NEO M	185
NEO S	185
NESS	22
NICO	434
NORIN	426
NUAGE	211
NUAGE	209
NUAGE L	210
NUAGE M	210
NUAGE S	210

O

OFFICE LED	230
OHIO	391
OIA LED	449
OIR	426
OLIMPIA	310
OSAKA SQUARE	352
OSLO	190
OSLO LED	191
OVAL	283

P

PAG	282
PANTOGRAPH	72
PAOLI	451
PATHWAY FOUNDATION KIT	420
PATHWAY LED	421
PATRAS LED	433
PEAK LED	441
PERM	69
PERTH	23
PETRA	103
PICCO LED L	450
PICCO LED M	450
PICCO LED S	450
PICO	15
PILE	34
PIREUS	304
PLANE	371
PLANT	98
PŁOMYK	334
POCATELLO	250
POINT L	289
POINT M	289
POINT PLEXI L	288
POINT PLEXI M	288
POINT S	289
POLARIS	202
POLE LED	419
POLY	65
POLY L	65
POLY M	64
POLY S	64
PRASLIN	374
PRIMM	437
PROFILE BIT	258
PROFILE BIT PLUS	261
PROFILE BUBBLE	258
PROFILE DEAD END CAP	265
PROFILE EYE	259
PROFILE EYE FLEX	260
PROFILE EYE SPOT	261
PROFILE EYE SUPER A	260
PROFILE EYE SUPER C	260
PROFILE FLEX	260
PROFILE IRIS LED 12W	254
PROFILE IRIS LED 20W	255
PROFILE IRIS LED 30W	255
PROFILE IRIS LED 7W	254
PROFILE L-CONNECTOR	265

PROFILE POWER END CAP	265	ROLLER	177
PROFILE POWER SUPPLY KIT	265	ROSETTE	344
PROFILE RECESSED	266		
PROFILE RECESSED DEAD END CAP	267	S	
PROFILE RECESSED FIXING SET	267	SALVA A	206
PROFILE RECESSED L-CONNECTOR	267	SALVA C	206
PROFILE RECESSED POWER END CAP	267	SALVA E	206
PROFILE RECESSED STRAIGHT CONNECTOR	267	SALVA G	207
PROFILE RECESSED T-CONNECTOR	266	SALVA H	207
PROFILE RECESSED TRACK 1 METER	266	SANTI LED	236
PROFILE RECESSED TRACK 2 METER	266	SCORPIO	219
PROFILE RECESSED X-CONNECTOR	267	SEMI LED	440
PROFILE SHOW LED 12W	256	SET	284
PROFILE STORE LED 12W	257	SHOP LED	281
PROFILE STORE LED 5W	257	SHY	122
PROFILE STORE LED 7W	257	SIERRA	425
PROFILE STRAIGHT CONNECTOR	265	SIGNPOST	364
PROFILE SUSPENSION KIT	265	SILICONE	105
PROFILE T-CONNECTOR	265	SILVERADO	330
PROFILE TRACK 1 METER	264	SIMPLE	106
PROFILE TRACK 2 METER	264	SIROCCO	426
PROFILE TRACK LIGHTS SYSTEM	264	SIS	386
PROFILE VESPA	261	SOFT LED 90×20	227
PROFILE WORKSHOP	258	SOFT LED 90×6	227
PROFILE X-CONNECTOR	265	SOFT LED 120×6	227
PROVENCE	452	SOFT LED 120×6	228
PUEBLA LED	444	SOFT LED 60×20	229
PUZZLE	363	SOFT LED 60×6	229
		SOFT LED 60×60	228
Q		SOFT LED 90×20	228
Q LED	224	SOFT LED 90×6	229
QUARTZ	446	SOLID	124
QUARTZ SENSOR	446	SOUL	413
QUEBECK	63	SPARTA	384
		SPEY	457
R		SPIDER	108
REFLECTOR GU10, ES111 LED COB, 15W	462	SPIKE LED	422
REFLECTOR GU10, ES111, LED COB, 12W	462	STALACTITE	45
REFLECTOR GU10, R50, LED 7W	463	STAR	409
REFLECTOR LED, ES111 LENS 9W	462	STEP LED	449
REFLECTOR LED, ES111 DIFFUSER 9W	462	STICKS	25
RETTO A	154	STONE GRAY	120
RETTO B	154	STONE TRAVERTINE	120
RETTO C	155	STRAIGHT LED CEILING L	220
RIO	424	STRAIGHT LED CEILING M	220
RIO SENSOR	424	STRAIGHT LED CEILING S	220
ROCK	428	STRAIGHT LED WALL L	222
ROD	30	STRAIGHT LED WALL M	222
		STRAIGHT LED WALL S	222

STRAIGHT WALL XS	222		
STUDENT	251		
SWIVEL	164		
		T	
TAHOE	396	TAHOE SENSOR	396
TAMPA	247	TAY	456
TAY	456	TECHNO	70
TECHNO	70	TEPIC LED	415
TESA	327	TESA	327
TESALLI	213	THIKA LED	423
THIKA LED	423	TORINO	192
TORINO	192	TORRENS	427
TORRENS	427	TOSCA M	184
TOSCA M	184	TOSCA S	184
TOSCA S	184	TOSCANA	215
TOSCANA	215	TOY-STAR	360
TOY-STAR	360	TRAIN	372
TRAIN	372	TUBE	235
TUBE	235	TUGELA	243
TUGELA	243	TULUM	105
TULUM	105	TURDA	134
TURDA	134	TWIG	36
TWIG	36	TWIST	332
TWIST	332	TYBR	455
TYBR	455		
		U	
UFO	218	UMBRELLA	19
UMBRELLA	19	UNIT LED	439
UNIT LED	439		
		V	
VAN GOGH LED L	380		
VAN GOGH LED M	381		
VAN GOGH LED S	381		
VELVET	350		
VER	239		
VESPA	273		
VETRO	199		
VICTORIA	320		
VINTAGE LED BULB	467		
VIPER	168		
VIVIANE	144		
VOLCANO L	115		

VOLCANO S	115		
		W	
WAVE L	11	WAVE S	11
WAVE S	11	WEZEN	176
WEZEN	176	WHEEL	172
WHEEL	172	WING LED	234
WING LED	234	WIOLETTA	340
WIOLETTA	340	WOOD BOY	193
WOOD BOY	193	WOOD DIAMOND	175
WOOD DIAMOND	175	WORKS	82
WORKS	82	WORKSHOP	40
WORKSHOP	40		
		Z	
ZELDA	170		
ZEM LED	440		
ZOA LED	443		

INDEKS LAMP / PROGRESSIVE CODE INDEX

INDEX	STRONA/PAGE	INDEX	STRONA/PAGE	INDEX	STRONA/PAGE	INDEX	STRONA/PAGE	INDEX	STRONA/PAGE	INDEX	STRONA/PAGE
002/01	251	1353	340	2998	320	3408	438	3755	397	4423	424
002/00	251	1509	316	3006	219	3411	446	3765	354	4424	424
050/00	218	1510	317	3007	219	3412	448	3908	347	4425	427
050/01	218	1511	317	3008	219	3413	354	3910	347	4426	427
202	336	1512	316	3118	396	3414	354	3912	347	4431	427
203	336	1513	317	3122	396	3415	354	4013	215	4440	446
204	336	1845	317	3240	396	3457	151	4014	214	4441	441
205	337	2205	349	3242	396	3458	150	4025	215	4441	441
206	336	2206	126	3243	396	3460	150	4064	372	4442	441
208	337	2207	126	3244	396	3464	151	4065	372	4443	441
401	324	2208	126	3250	396	3465	150	4134	341	4444	440
402	324	2267	345	3251	396	3466	150	4136	341	4446	426
403	325	2272	345	3346	390	3471	146	4137	315	4447	418
404	325	2274	345	3347	390	3473	147	4138	315	4448	418
405	325	2280	348	3350	391	3483	318	4140	313	4453	448
406	324	2281	348	3361	306	3484	319	4168	182	4454	451
408	324	2282	348	3362	307	3485	318	4171	182	4465	156
409	325	2283	348	3363	307	3486	319	4173	182	4466	157
481	334	2410	127	3364	307	3524	323	4174	182	4524	215
483	334	2411	127	3365	307	3525	323	4223	373	4525	349
484	335	2468	350	3367	309	3526	323	4290	357	4558	328
485	334	2469	350	3368	308	3527	322	4291	357	4561	328
491	335	2470	350	3370	309	3528	323	4292	357	4562	328
493	335	2763	333	3372	308	3564	391	4301	356	4563	329
976	381	2764	333	3373	308	3571	348	4302	356	4607	20
1051	327	2765	333	3374	309	3596	212	4303	356	4608	20
1052	327	2766	333	3375	304	3644	338	4326	373	4610	20
1055	327	2767	332	3376	304	3645	338	4353	310	4611	20
1129	346	2768	314	3380	304	3646	338	4354	310	4614	20
1130	346	2770	313	3382	248	3648	338	4355	311	4615	20
1131	346	2771	312	3393	417	3650	339	4356	310	4648	213
1135	346	2772	312	3394	417	3656	367	4357	310	4650	213
1136	346	2902	352	3396	426	3657	366	4386	391	4651	213
1157	351	2903	352	3401	447	3660	366	4390	417	4652	213
1337	351	2904	352	3402	429	3661	367	4397	306	4653	213
1338	351	2985	239	3403	429	3662	366	4398	304	4654	213
1339	351	2994	321	3404	429	3728	157	4418	416	4684	455
1350	340	2995	321	3405	428	3730	156	4420	416	4685	455
1351	340	2996	321	3406	428	3750	397	4421	425	4686	455
1352	340	2997	320	3407	428	3752	397	4422	425	4687	458

INDEX	STRONA/PAGE	INDEX	STRONA/PAGE	INDEX	STRONA/PAGE	INDEX	STRONA/PAGE	INDEX	STRONA/PAGE	INDEX	STRONA/PAGE
4692	454	5052	86	5291	457	5428	206	5678	66	5947	257
4693	454	5053	87	5292	456	5451	127	5680	66	5948	257
4694	454	5056	87	5293	456	5455	53	5681	66	5950	257
4698	416	5057	88	5294	456	5456	53	5682	66	5954	298
4730	161	5058	88	5295	23	5457	53	5692	344	5955	298
4731	161	5060	89	5296	23	5463	52	5694	344	5956	298
4745	319	5061	89	5297	23	5464	52	5705	67	5958	299
4746	319	5066	81	5298	23	5465	52	5706	67	5960	299
4838	94	5067	81	5300	23	5471	52	5707	67	5990	314
4840	94	5073	93	5301	23	5472	52	5708	67	5991	314
4841	93	5074	93	5302	375	5473	52	5710	67	5993	315
4842	94	5077	97	5303	374	5491	23	5711	67	5994	313
4843	94	5078	97	5304	374	5492	23	5718	67	5995	313
4844	94	5082	97	5322	218	5524	78	5720	67	5996	312
4856	93	5083	97	5330	239	5526	78	5721	67	5997	312
4865	286	5125	21	5332	239	5527	78	5723	149	5998	314
4866	286	5126	21	5343	143	5530	79	5724	147	6000	289
4867	286	5133	241	5344	142	5531	79	5725	278	6001	289
4893	94	5134	241	5345	142	5532	79	5726	278	6002	289
4900	459	5197	154	5347	143	5533	79	5727	278	6003	289
4901	459	5208	216	5348	143	5534	79	5728	279	6006	289
4902	459	5210	216	5350	143	5554	86	5731	279	6007	289
4906	426	5211	216	5351	143	5568	291	5732	278	6008	289
4907	448	5212	217	5352	142	5570	291	5733	278	6010	170
4917	248	5214	217	5353	142	5573	291	5734	278	6011	171
4923	346	5218	217	5380	154	5574	291	5735	279	6012	170
4952	204	5221	217	5383	149	5575	291	5737	279	6014	274
4953	204	5255	52	5384	149	5588	355	5753	157	6015	274
4961	147	5256	52	5386	149	5590	355	5754	156	6016	274
4962	146	5257	52	5397	53	5646	78	5755	157	6017	275
4963	146	5261	214	5398	53	5647	78	5756	156	6018	274
4966	448	5262	214	5400	53	5654	55	5760	344	6020	274
4976	352	5263	214	5403	63	5655	55	5763	204	6021	274
4977	352	5264	390	5404	63	5656	55	5764	204	6022	275
4978	352	5265	390	5405	63	5660	147	5794	250	6023	101
4981	333	5266	238	5406	63	5662	151	5795	250	6030	101
4982	333	5267	238	5410	21	5663	151	5796	250	6031	100
4983	333	5270	143	5411	21	5664	88	5797	250	6032	101
4984	333	5271	143	5415	330	5665	87	5798	250	6033	100
4985	332	5272	238	5417	330	5673	66	5800	247	6035	101
4996	314	5286	143	5418	330	5674	66	5828	250	6134	274
4997	314	5287	143	5420	330	5675	66	5844	275	6135	274
5021	467	5288	143	5422	206	5676	66	5945	281	6136	274
5048	86	5290	457	5424	206	5677	66	5946	281	6137	275































INDEX	STRONA/PAGE	INDEX	STRONA/PAGE	INDEX	STRONA/PAGE	INDEX	STRONA/PAGE	INDEX	STRONA/PAGE	INDEX	STRONA/PAGE
6138	274	6427	290	6551	171	6771	395	6855	115	6973	106
6140	274	6442	85	6552	164	6772	144	6856	118	6974	106
6141	274	6443	84	6553	164	6773	144	6857	119	6975	106
6142	100	6444	85	6558	164	6774	144	6858	118	6976	404
6143	101	6445	85	6560	164	6775	440	6868	76	6977	404
6144	100	6487	58	6583	102	6776	440	6870	77	6978	404
6145	101	6488	57	6584	102	6777	96	6871	77	7014	120
6227	251	6490	57	6585	102	6778	96	6878	192	7015	120
6267	26	6491	59	6586	102	6785	110	6880	181	7016	446
6268	26	6492	59	6587	102	6786	108	6883	181	7017	424
6270	26	6493	58	6588	102	6787	110	6893	369	7021	210
6301	247	6494	58	6590	272	6788	110	6894	368	7022	210
6308	145	6495	57	6598	102	6790	108	6895	369	7023	210
6310	145	6496	57	6600	102	6791	110	6896	368	7024	209
6311	145	6497	59	6601	102	6792	110	6897	369	7025	209
6326	376	6498	59	6602	102	6794	110	6898	368	7026	209
6327	376	6500	58	6603	102	6800	161	6900	369	7027	209
6328	326	6501	58	6604	102	6812	149	6901	368	8794	197
6330	326	6502	57	6605	40	6815	149	6902	371	8795	420
6331	162	6503	57	6606	40	6816	149	6903	371	8796	46
6332	162	6504	59	6607	275	6817	148	6904	371	8797	46
6333	180	6505	59	6608	275	6818	149	6907	449	8798	46
6334	180	6506	58	6610	275	6820	155	6908	449	8800	48
6335	40	6508	82	6611	275	6822	299	6910	439	8801	99
6336	40	6510	82	6612	82	6823	299	6911	458	8802	136
6337	40	6511	82	6613	82	6824	257	6912	236	8805	267
6338	180	6512	168	6615	367	6825	257	6913	236	8806	272
6340	180	6513	168	6623	145	6826	257	6927	183	8807	272
6344	99	6522	272	6624	145	6836	52	6928	82	8808	272
6345	222	6523	272	6630	58	6837	52	6930	92	8810	272
6350	222	6524	272	6631	58	6838	52	6931	92	8811	278
6354	222	6525	288	6632	58	6840	53	6932	95	8812	278
6367	90	6526	288	6640	168	6841	53	6933	95	8813	279
6368	90	6527	288	6641	168	6842	55	6934	95	8814	278
6370	90	6528	288	6724	394	6844	22	6940	22	8815	279
6371	90	6530	288	6725	394	6845	207	6941	22	8816	274
6382	363	6531	288	6726	395	6846	207	6943	388	8817	274
6383	363	6532	144	6727	395	6847	236	6944	388	8818	274
6384	363	6534	193	6736	376	6848	242	6945	388	8819	275
6390	144	6535	193	6764	241	6850	242	6948	389	8820	275
6391	144	6540	169	6765	241	6851	242	6950	389	8821	465
6403	105	6541	169	6767	22	6852	115	6951	389	8822	258
6404	105	6545	164	6768	22	6853	115	6971	301	8823	258
6422	290	6546	164	6770	394	6854	115	6972	301	8824	261

INDEX	STRONA/PAGE	INDEX	STRONA/PAGE	INDEX	STRONA/PAGE	INDEX	STRONA/PAGE	INDEX	STRONA/PAGE	INDEX	STRONA/PAGE
8825	261	8874	19	8923	46	8977	177	9033	173	9085	148
8826	297	8875	64	8924	46	8978	160	9034	172	9086	150
8827	243	8876	64	8925	285	8980	160	9035	172	9087	146
8828	243	8877	64	8926	285	8981	161	9036	173	9088	150
8830	396	8878	64	8928	285	8982	161	9037	176	9090	148
8831	396	8880	65	8930	285	8988	300	9038	176	9091	146
8832	394	8881	65	8931	285	8990	300	9040	176	9094	452
8833	394	8882	65	8932	285	8991	300	9041	176	9096	453
8834	267	8883	65	8934	54	8992	300	9042	189	9097	424
8835	267	8884	65	8935	54	8993	280	9043	189	9098	422
8836	267	8885	65	8936	296	8994	280	9044	189	9100	422
8837	267	8886	74	8937	296	8995	254	9045	32	9101	422
8838	273	8887	74	8938	296	8996	254	9046	32	9102	449
8840	273	8888	74	8940	296	8997	254	9047	32	9103	449
8841	273	8890	74	8942	131	8998	254	9048	184	9104	450
8842	273	8891	75	8943	131	9000	254	9050	184	9105	450
8843	169	8892	75	8944	131	9001	254	9054	45	9106	450
8844	169	8893	75	8945	134	9002	254	9055	45	9107	431
8845	465	8894	75	8946	135	9003	254	9056	202	9108	431
8846	465	8895	284	8947	135	9004	255	9057	202	9110	431
8847	13	8896	284	8948	139	9005	255	9058	202	9111	431
8848	14	8897	284	8950	136	9006	255	9060	202	9112	430
8850	13	8898	284	8951	133	9007	255	9061	44	9113	430
8851	13	8900	284	8952	134	9008	255	9062	362	9114	433
8852	14	8901	284	8953	135	9009	255	9063	362	9115	433
8853	13	8902	284	8954	132	9010	255	9064	362	9116	432
8854	19	8903	284	8955	136	9011	255	9065	364	9117	432
8855	11	8904	225	8956	139	9012	266	9066	364	9118	423
8856	11	8905	225	8957	132	9013	266	9067	54	9120	423
8857	11	8906	224	8958	134	9014	266	9068	54	9121	423
8858	11	8907	224	8960	135	9015	266	9070	54	9122	439
8860	11	8908	223	8961	139	9018	261	9071	163	9123	438
8861	11	8910	223	8962	133	9020	261	9072	163	9124	438
8862	15	8911	49	8965	401	9021	9	9073	163	9125	421
8863	15	8912	49	8966	401	9022	9	9074	163	9126	72
8864	17	8913	49	8967	267	9023	9	9075	165	9127	34
8865	17	8914	48	8968	267	9024	9	9076	25	9128	34
8866	17	8915	51	8970	267	9025	8	9077	25	9130	30
8867	17	8916	51	8971	267	9026	8	9078	148	9131	199
8868	17	8917	51	8972	267	9027	30	9080	150	9132	199
8870	17	8918	46	8973	267	9028	173	9081	150	9133	177
8871	129	8920	46	8974	267	9030	172	9082	146	9134	177
8872	129	8921	46	8975	267	9031	172	9083	148	9135	35
8873	19	8922	46	8976	177	9032	173	9084	146	9136	35

INDEX	STRONA/PAGE	INDEX	STRONA/PAGE	INDEX	STRONA/PAGE	INDEX	STRONA/PAGE	INDEX	STRONA/PAGE	INDEX	STRONA/PAGE
9137	37	9188	265	9285	365	9345	462	9397	277	9490	243
9138	36	9190	265	9286	365	9346	381	9398	277	9491	243
9140	37	9191	60	9290	365	9347	381	9400	277	9492	243
9141	36	9192	60	9293	360	9348	381	9403	295	9493	243
9142	71	9197	463	9294	29	9350	381	9404	295	9495	293
9143	71	9211	462	9295	234	9351	381	9407	295	9496	293
9144	70	9212	462	9296	28	9352	381	9408	295	9497	293
9145	70	9213	462	9297	29	9353	387	9412	294	9500	393
9146	69	9214	462	9298	160	9354	387	9413	294	9501	393
9147	69	9218	161	9300	161	9355	230	9416	294	9502	383
9148	69	9237	265	9301	161	9356	230	9417	294	9503	383
9150	73	9238	265	9302	161	9357	231	9418	409	9504	385
9151	73	9240	283	9303	160	9358	230	9420	421	9505	386
9152	201	9241	283	9304	161	9360	230	9421	443	9506	386
9153	201	9244	260	9306	204	9362	196	9422	442	9507	415
9154	201	9245	260	9307	204	9363	196	9423	256	9508	415
9155	201	9246	408	9308	197	9364	197	9424	256	9510	435
9156	384	9247	85	9310	174	9365	185	9425	408	9511	435
9157	384	9248	234	9311	190	9366	185	9426	409	9512	435
9158	426	9250	234	9312	190	9367	152	9427	258	9513	444
9160	244	9252	421	9313	190	9370	153	9448	264	9514	444
9161	244	9253	464	9314	191	9371	152	9450	264	9515	434
9162	244	9254	464	9315	191	9372	175	9451	264	9516	434
9163	244	9255	464	9316	283	9373	153	9452	264	9517	434
9164	244	9256	179	9317	235	9374	198	9453	265	9518	434
9165	244	9257	178	9318	235	9375	174	9454	265	9522	229
9166	245	9258	178	9320	235	9376	361	9455	265	9523	229
9167	245	9260	179	9321	261	9377	174	9456	265	9524	229
9168	245	9261	179	9322	261	9378	297	9457	265	9525	229
9170	245	9262	179	9324	260	9381	98	9458	265	9526	229
9171	245	9263	178	9325	260	9382	98	9460	265	9527	229
9172	245	9264	178	9328	260	9383	283	9461	265	9528	228
9173	463	9265	179	9330	260	9384	282	9462	265	9530	228
9174	380	9266	179	9331	260	9385	282	9463	265	9531	228
9175	380	9272	211	9332	260	9386	282	9466	231	9532	228
9176	380	9273	113	9335	258	9387	282	9470	293	9533	228
9177	463	9274	113	9336	258	9388	123	9471	293	9534	228
9178	463	9275	166	9337	259	9390	123	9472	293	9535	228
9180	463	9276	166	9338	259	9391	122	9481	287	9536	228
9181	462	9277	166	9340	382	9392	123	9482	287	9537	228
9182	462	9278	166	9341	465	9393	123	9483	287	9538	228
9185	419	9280	186	9342	462	9394	277	9484	287	9540	228
9186	265	9281	186	9343	462	9395	277	9485	287	9541	228
9187	265	9282	186	9344	462	9396	277	9486	287	9542	227

INDEX	STRONA/PAGE	INDEX	STRONA/PAGE	INDEX	STRONA/PAGE	INDEX	STRONA/PAGE	INDEX	STRONA/PAGE	INDEX	STRONA/PAGE
9543	227	9596	271	9626	220	9687	141	9720	124	9764	167
9544	227	9597	271	9627	220	9688	141	9721	124	9765	113
9545	227	9598	271	9628	220	9691	105	9723	188	9766	113
9546	227	9600	271	9631	41	9692	105	9724	188	9767	113
9547	227	9601	271	9633	124	9695	117	9725	188	9768	112
9551	437	9602	271	9634	190	9696	117	9728	363	9770	112
9552	437	9603	271	9635	191	9697	117	9730	363	9771	113
9553	437	9604	271	9665	38	9698	191	9731	158	9772	113
9554	451	9605	140	9666	38	9700	190	9733	30	9773	113
9555	413	9606	140	9667	38	9701	190	9734	30	9774	112
9556	413	9607	403	9668	38	9702	233	9735	26	9775	112
9557	413	9610	222	9670	38	9703	233	9736	159	9793	467
9558	413	9611	222	9672	130	9704	233	9737	159	9794	467
9560	413	9612	222	9673	130	9705	233	9738	43	9795	467
9564	445	9613	222	9674	60	9706	232	9740	42	9796	467
9565	445	9614	222	9675	60	9707	232	9741	42	9797	467
9570	293	9615	222	9676	60	9708	232	9742	42	9798	103
9571	293	9616	222	9677	60	9710	232	9743	108	9831	462
9572	293	9617	222	9678	60	9711	406	9744	108	9847	180
9573	293	9618	222	9680	60	9712	406	9745	108	9848	180
9574	293	9620	220	9681	141	9713	406	9746	104	9890	76
9575	293	9621	220	9682	141	9714	404	9747	104		
9592	273	9622	220	9683	141	9715	403	9751	403		
9593	273	9623	220	9684	140	9716	186	9754	167		
9594	273	9624	220	9685	140	9717	186	9758	167		
9595	273	9625	220	9686	141	9718	186	9760	167		

KODY KOLORÓW / COLOR CODES

 WH - WHITE	 NT - NATURAL	 PI - LIGHT PINK
 BL - BLACK	 G - GOLD	 P - PINK
 TA - TAUPE	 CO - COOPER	 B - BLUE
 GR - GRAPHITE	 CH - CHROM	 GN - GREEN
 GY - GRAY	 NI - NICKEL	 R - RED
 SI - SILVER	 INOX - STAINLESS STEEL	 AN GY - ANTIQUE GRAY
 CE - COFFE	 TR - TRANSPARENT	 BR - BROWN
 CN - CONCRETE	 OAK	 AN BR - ANTIQUE BROWN
 CHT - CHOCOLATE	 SMOKED OAK	 EC - ECRU
 BS - BRASS	 WE - WENGE	 TU - TURQUOISE

Nowodvorski
LIGHTING

Nowodvorski sp.j.
ul. Bojemskiego 11
42-202 Częstochowa
POLAND

tel.: +48 34 344 91 10 / 11
fax: +48 34 344 91 12
e-mail: nowodvorski@nowodvorski.com
www.nowodvorski.com

Design & production:

GRAFFITI
CREATIVE PEOPLE

REKLAMA & MEDIA
www.graffiti.com.pl